

Liquid Analysis Wiring Diagram Control Document

- This document was created to address the problem of inconsistently formatted and contradictory wiring diagrams in customer facing product literature.
- This document is meant to serve as the authoritative source of truth for Liquid Analysis sensor-to-transmitter wiring diagrams. It was developed through collaboration between Product Management, Customer Care, and Engineering.
- The intent is that whenever a wiring diagram is published in a customer facing document it should be a screenshot from this engineering-controlled document.
- Whenever a new wiring diagrams is needed, or an existing wiring diagram needs to be corrected this document should be updated first so that it remains up to date and comprehensive.
- Each wiring diagram in this document is marked with a drawing number. The intent is that these drawing numbers be included in the screenshots that are published in customer facing documents so that there is a clear connection between externally published wiring diagrams and this document, including revision numbers.
- Whenever a revision is made to this document, the revision number of the impacted drawing should be updated as well as the revision number of the overall document.

Revision History

Revision	Date	Notes
AA	1/26/2023	Initial version for upload to Teamcenter

pH/ORP Sensors

Rosemount Core Preamp pH/ORP Sensors With Blue Cable and Solution Ground

396P (with preamp)
396PVP (with preamp)
396RVP (with preamp)
3300HTVP (with preamp)
3400HTVP (with preamp)
3500P (with preamp)
3500VP (with preamp)
3900 (with preamp)
3900VP (with preamp)

Rosemount 396P, 396PVP, 396RVP, 3300HTVP, 3400HTVP, 3500P, 3500VP, 3900, or 3900VP pH/ORP Sensor (With Pre-amplifier) to Rosemount 56, 1056, 1057, or 1058 Transmitter Wiring

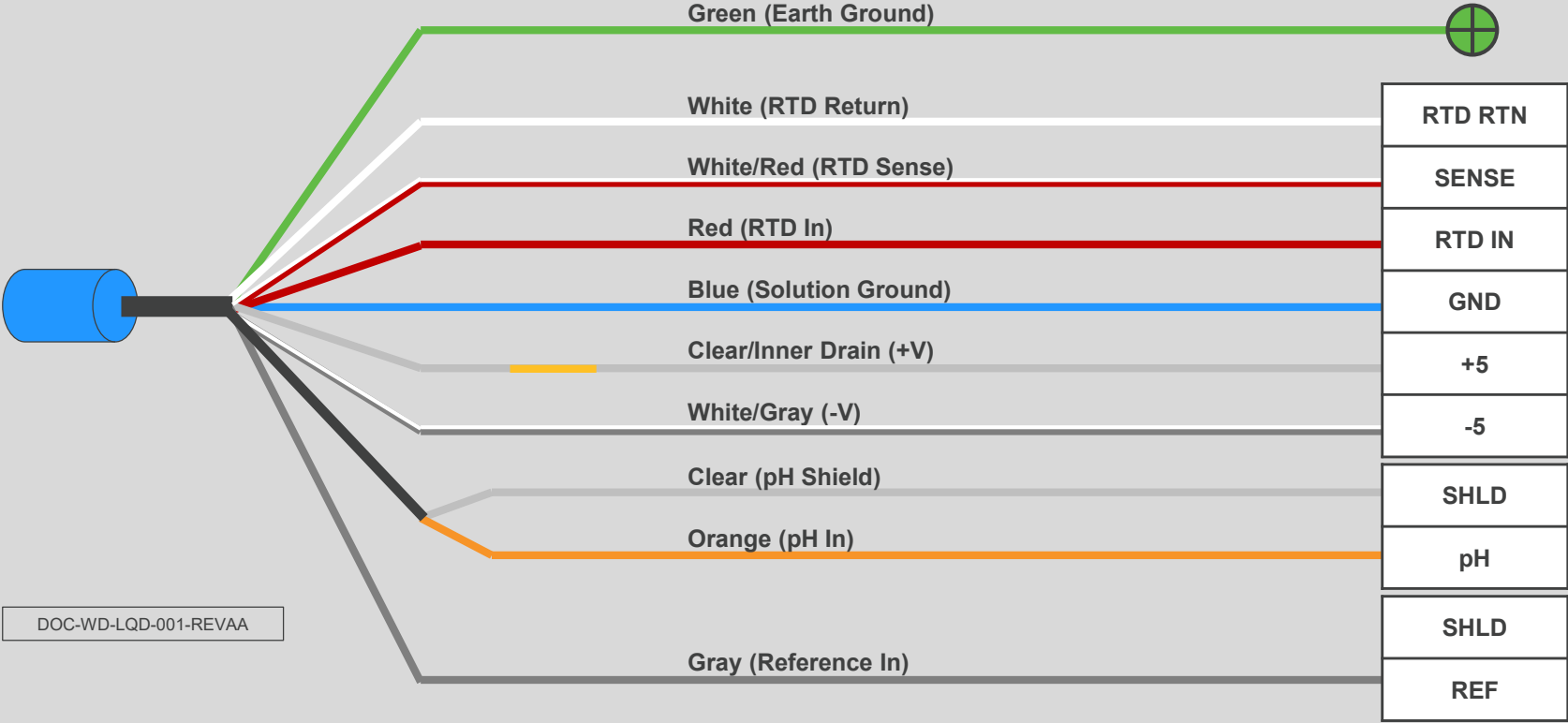

Rosemount 396P, 396PVP, 396RVP, 3300HTVP, 3400HTVP, 3500P, 3500VP, 3900, or 3900VP pH/ORP Sensor (With Pre-amplifier) to Rosemount 1066 Transmitter Wiring

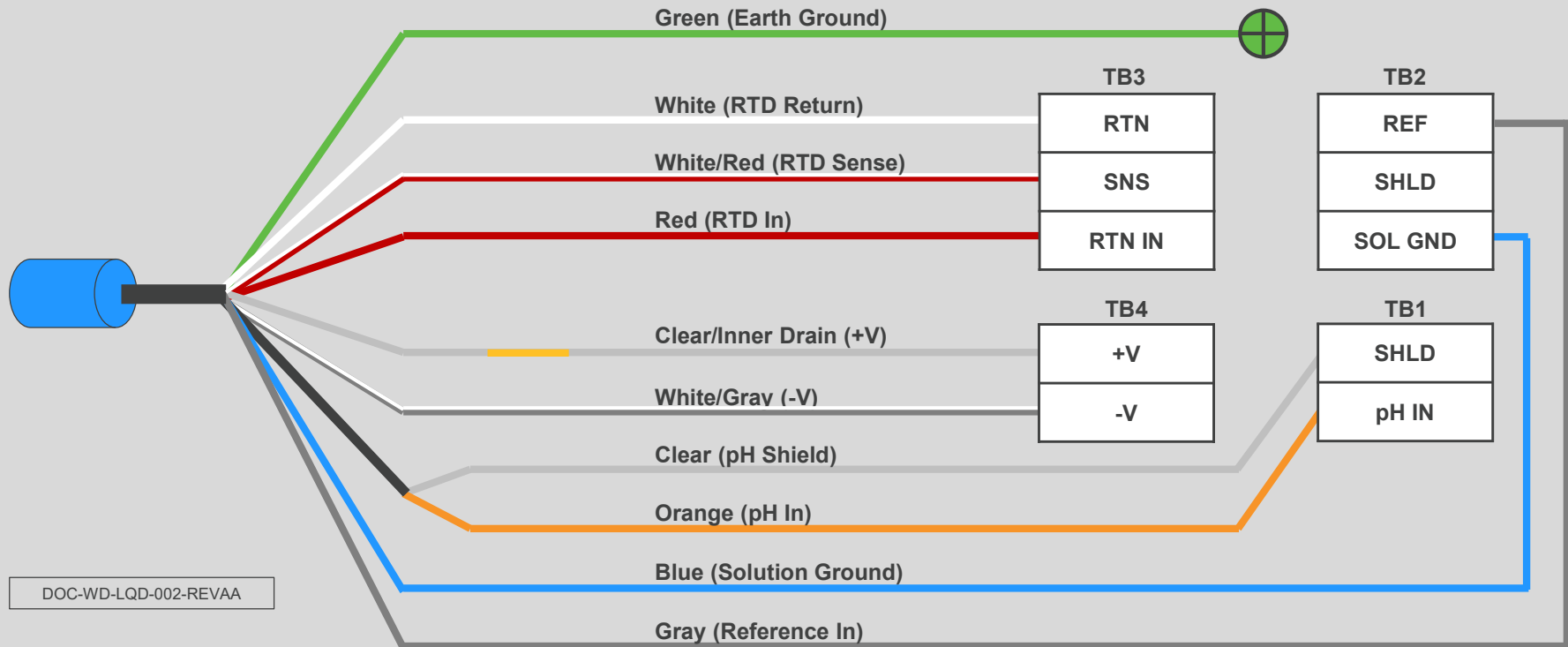

DOC-WD-LQD-002-REVA A

Rosemount 396P, 396PVP, 396RVP, 3300HTVP, 3400HTVP, 3500P, 3500VP, 3900, or 3900VP pH/ORP Sensor (With Pre-amplifier) to Rosemount 5081 Transmitter Wiring

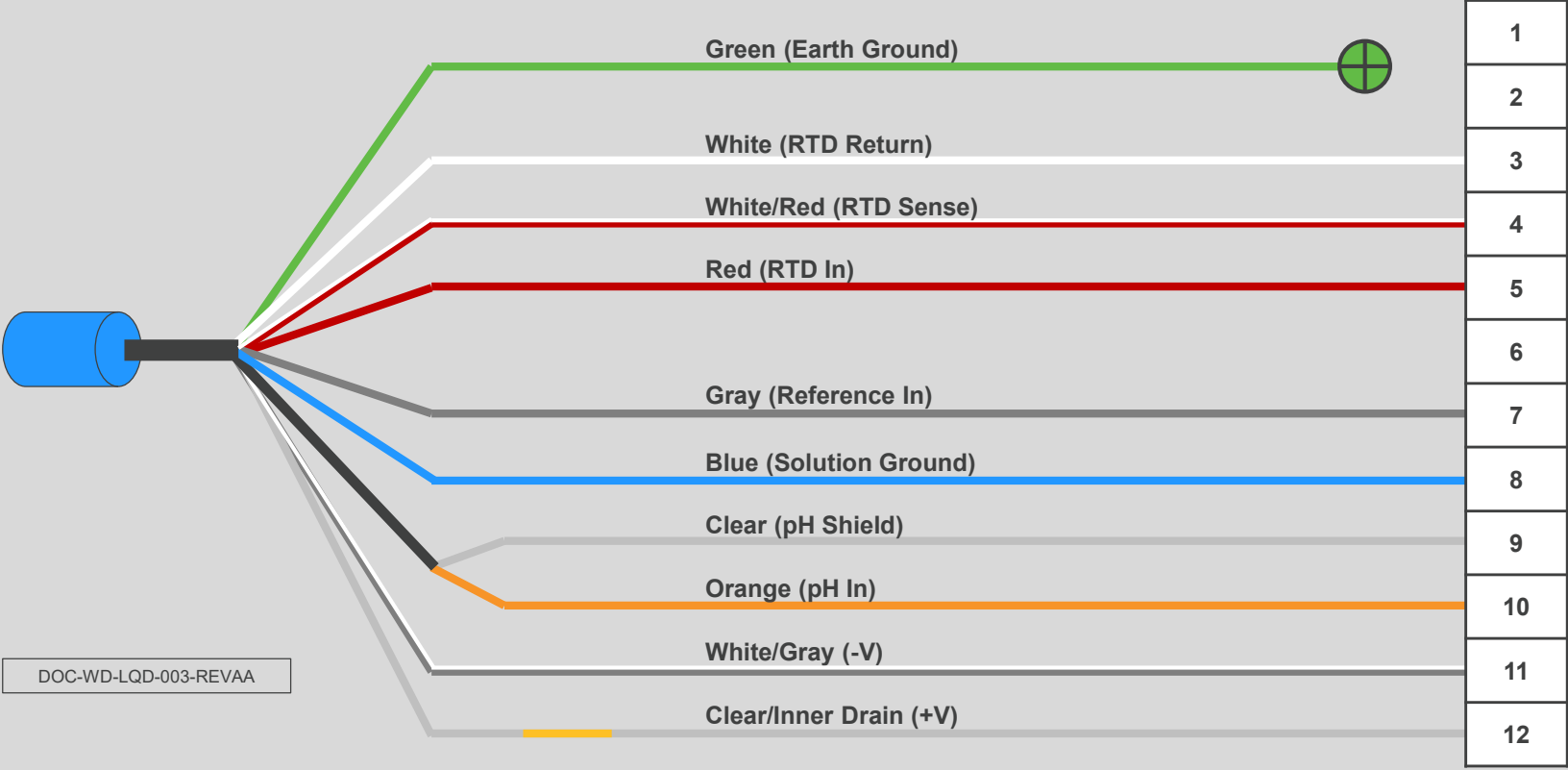

DOC-WD-LQD-003-REVA A

Rosemount Core Analog pH/ORP Sensors With Blue Cable and Solution Ground

396P (without preamp)
396PVP (without preamp)
396R (all options)
396RVP (without preamp)
3300HT (all options)
3300HTVP (without preamp)
3400HT (all options)
3400HTVP (without preamp)
3500P (without preamp)
3500VP (without preamp)
3900 (without preamp)
3900VP (without preamp)

Rosemount 396P, 396PVP, 396R, 396RVP, 3300HT, 3300HTVP, 3400HT, 3400HTVP, 3500P, 3500VP, 3900, or 3900VP pH/ORP Sensor (Without Pre-amplifier) to Rosemount 56, 1056, 1057, or 1058 Transmitter Wiring

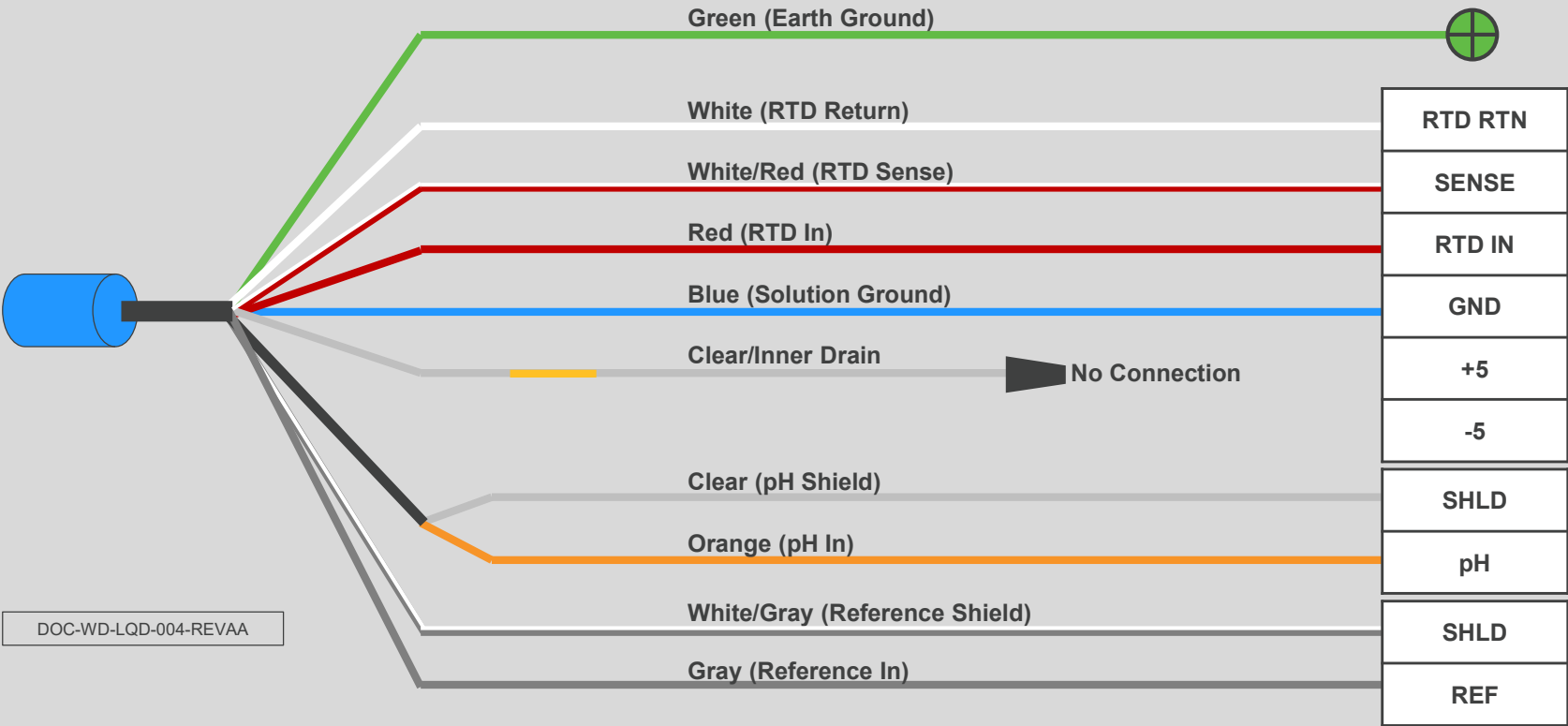

DOC-WD-LQD-004-REVA

Rosemount 396P, 396PVP, 396R, 396RVP, 3300HT, 3300HTVP, 3400HT, 3400HTVP, 3500P, 3500VP, 3900, or 3900VP pH/ORP Sensor (Without Pre-amplifier) to Rosemount 1066 Transmitter Wiring

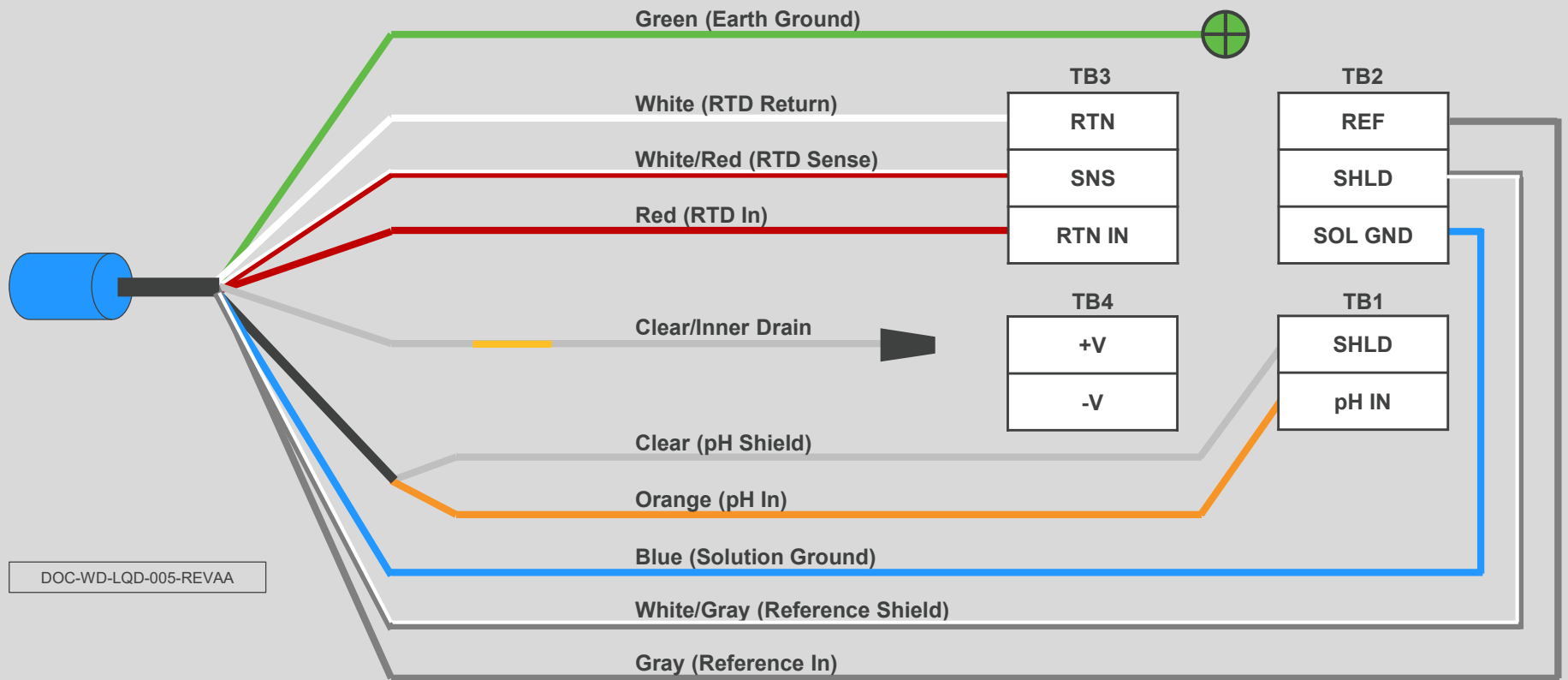

DOC-WD-LQD-005-REVA A

Rosemount 396P, 396PVP, 396R, 396RVP, 3300HT, 3300HTVP, 3400HT, 3400HTVP, 3500P, 3500VP, 3900, or 3900VP pH/ORP Sensor (Without Pre-amplifier) to Rosemount 5081 Transmitter Wiring

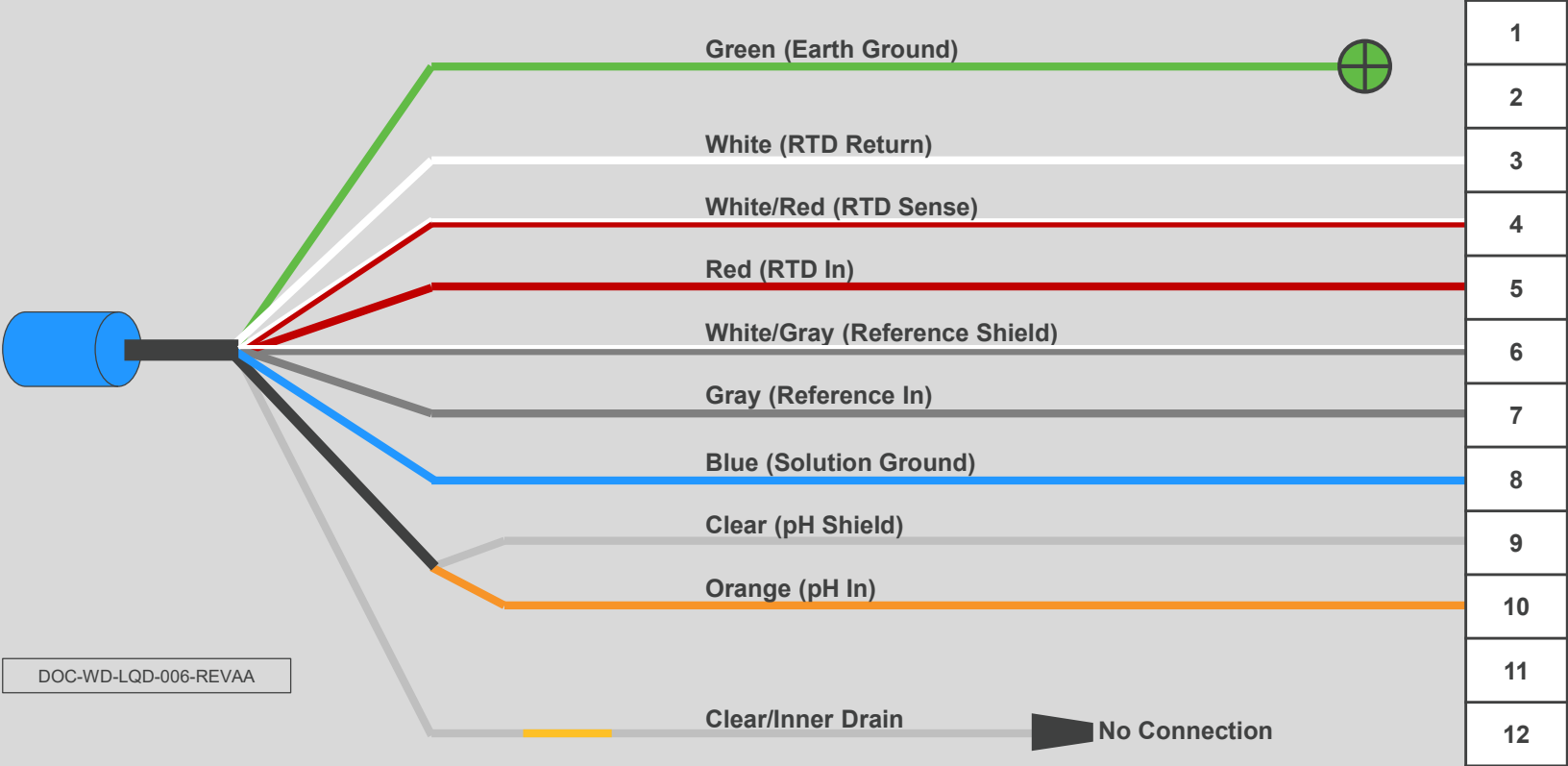

DOC-WD-LQD-006-REVA

Rosemount Core Preamp pH/ORP Sensors with Gray Cable and Solution Ground

385+-02 (sensor head junction box, with preamp)
385+-03 (gray cable, with preamp)

Rosemount 385+-02, or 385+-03 pH/ORP Sensor (With Preamp) to Rosemount 56, 1056, 1057, or 1058 Transmitter Wiring

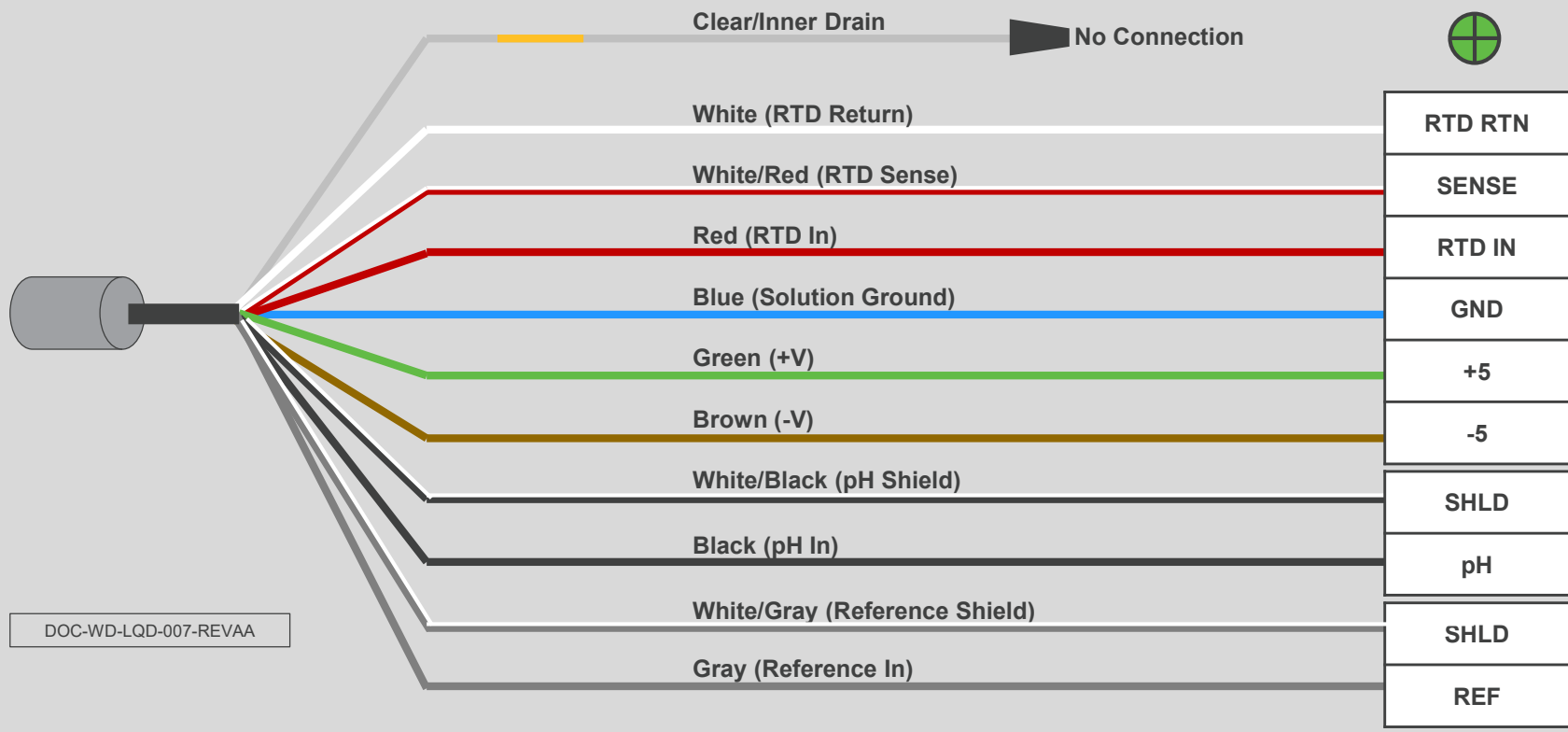

DOC-WD-LQD-007-REVA A

If there is a shrink sleeve on the gray reference wire, remove it before connecting the wire to the terminal.

Rosemount 385+-02, or 385+-03 pH/ORP Sensor (With Preamp) to Rosemount 1066 Transmitter Wiring

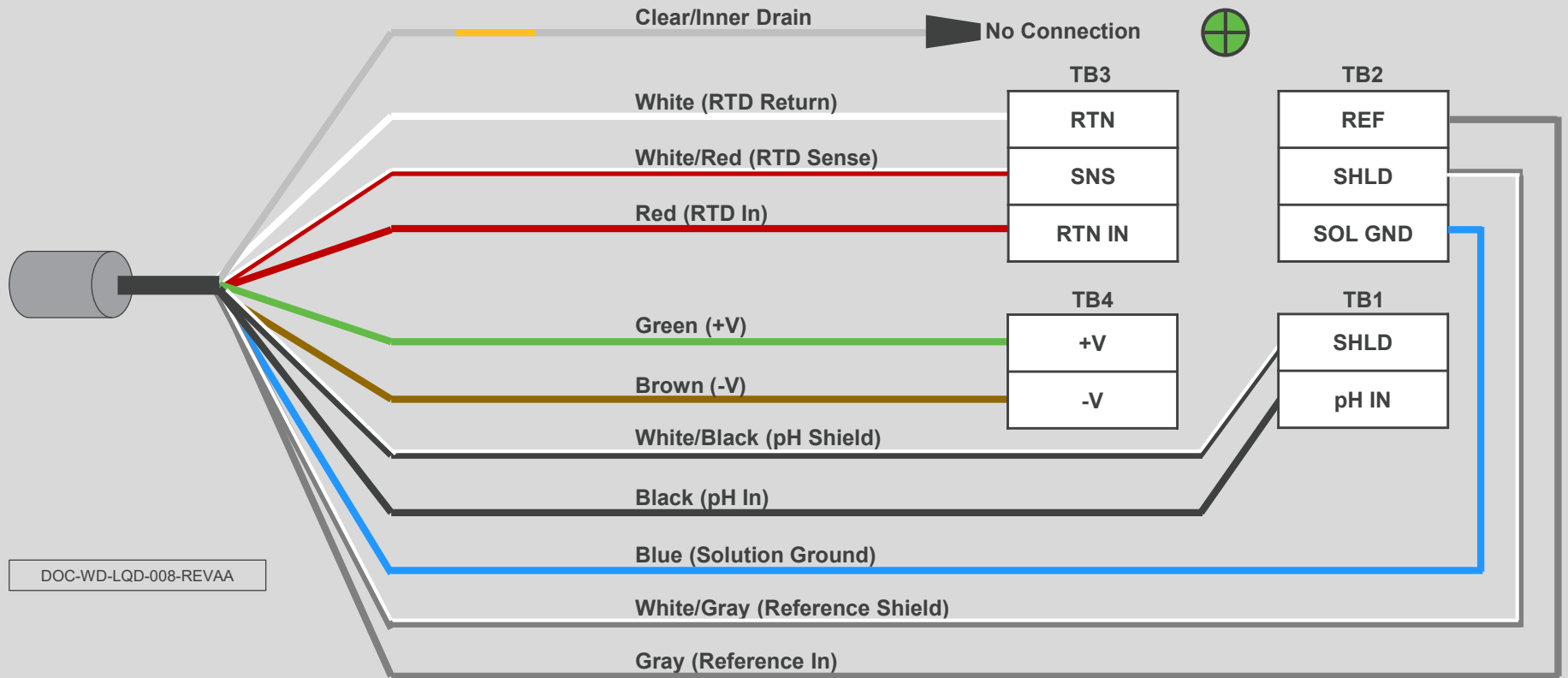

DOC-WD-LQD-008-REVA A

If there is a shrink sleeve on the gray reference wire, remove it before connecting the wire to the terminal.

Rosemount 385+-02, or 385+-03 pH/ORP Sensor (With Preamp) to Rosemount 5081 Transmitter Wiring

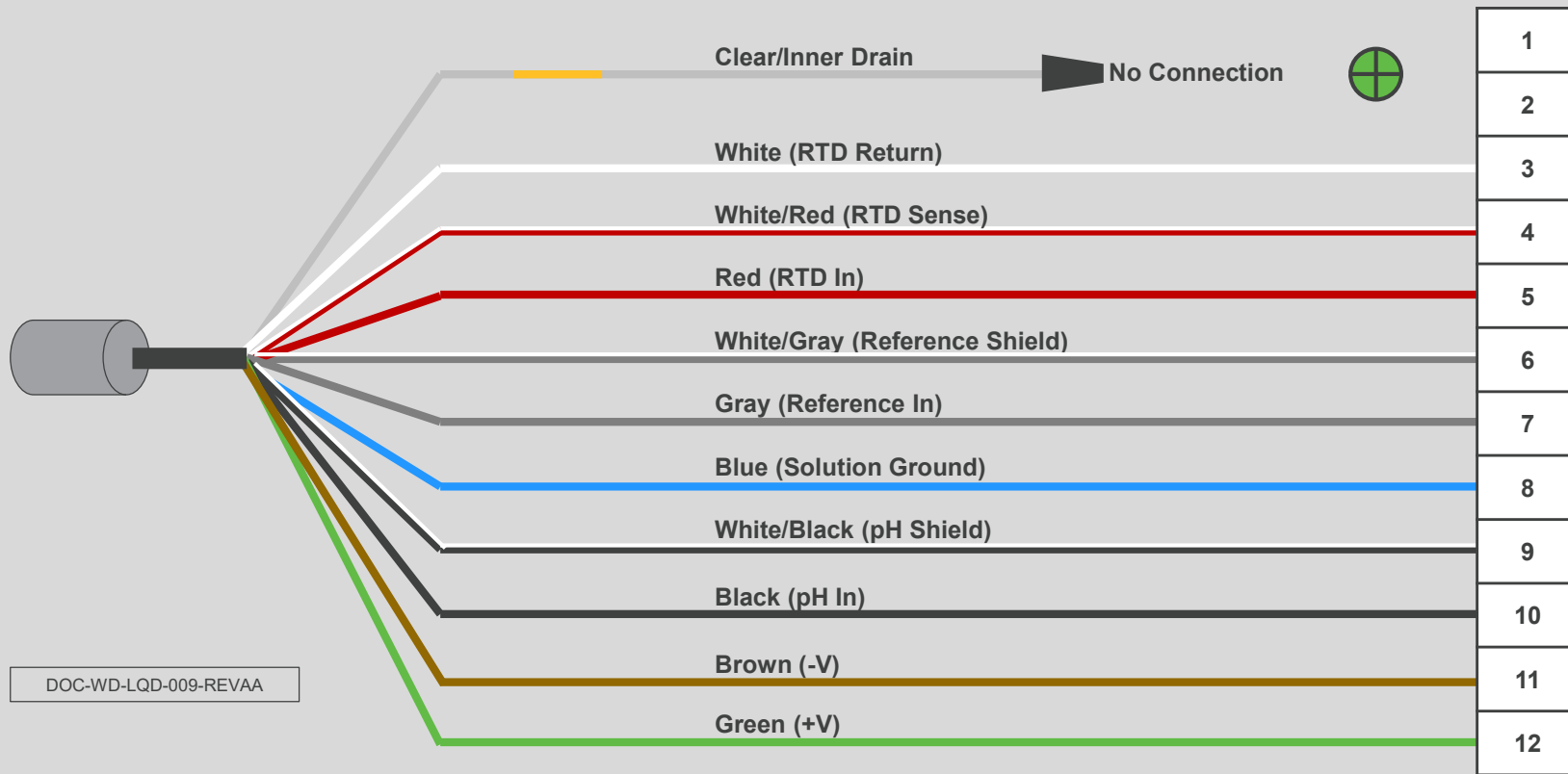

DOC-WD-LQD-009-REVA A

If there is a shrink sleeve on the gray reference wire, remove it before connecting the wire to the terminal.

Rosemount Core Analog pH/ORP Sensors with Gray Cable and Solution Ground

385+-04 (gray cable, without preamp)

Rosemount 385+-04 pH/ORP Sensor (Without Preamp) to Rosemount 56, 1056, 1057, or 1058 Transmitter Wiring

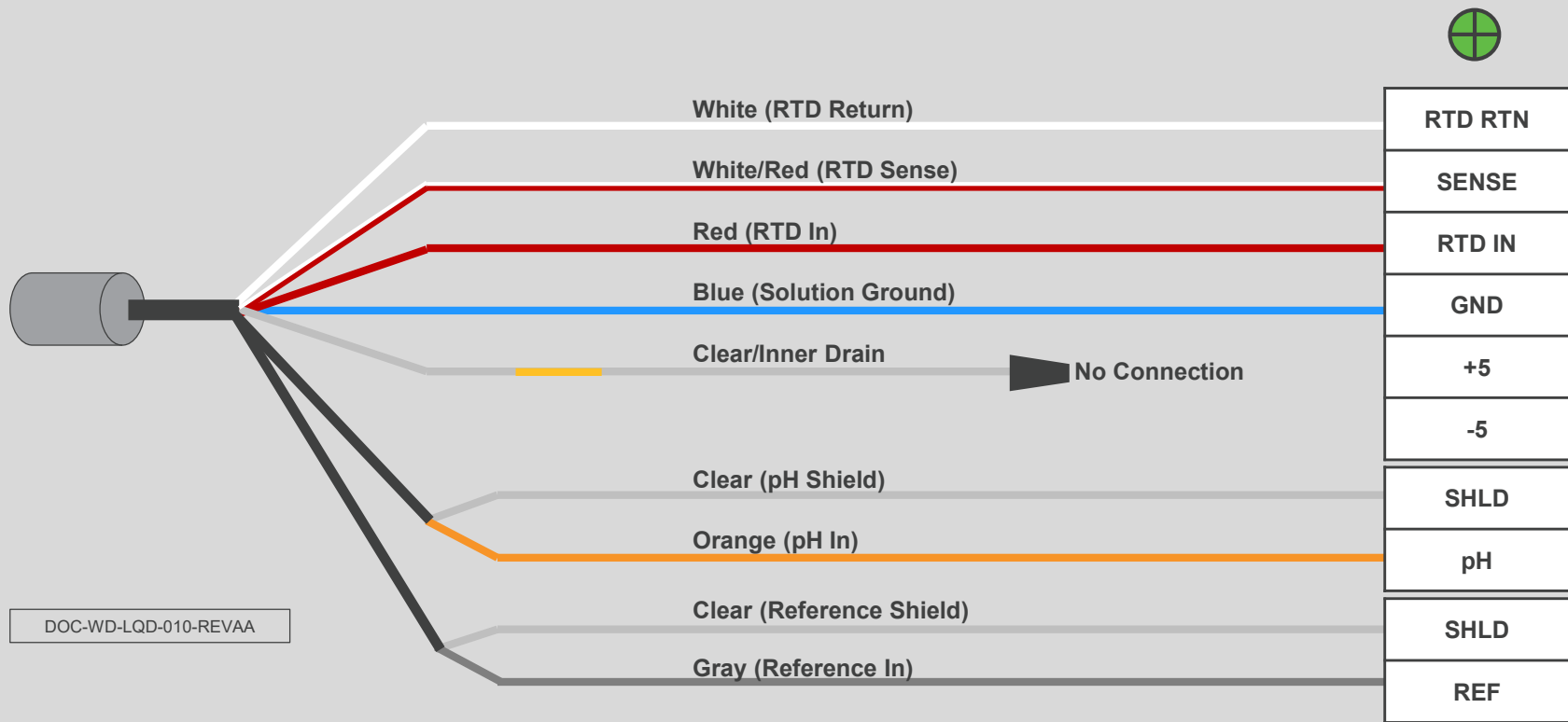

DOC-WD-LQD-010-REVA A

If there is a shrink sleeve on the gray reference wire, remove it before connecting the wire to the terminal.

Rosemount 385+-04 pH/ORP Sensor (Without Preamp) to Rosemount 1066 Transmitter Wiring

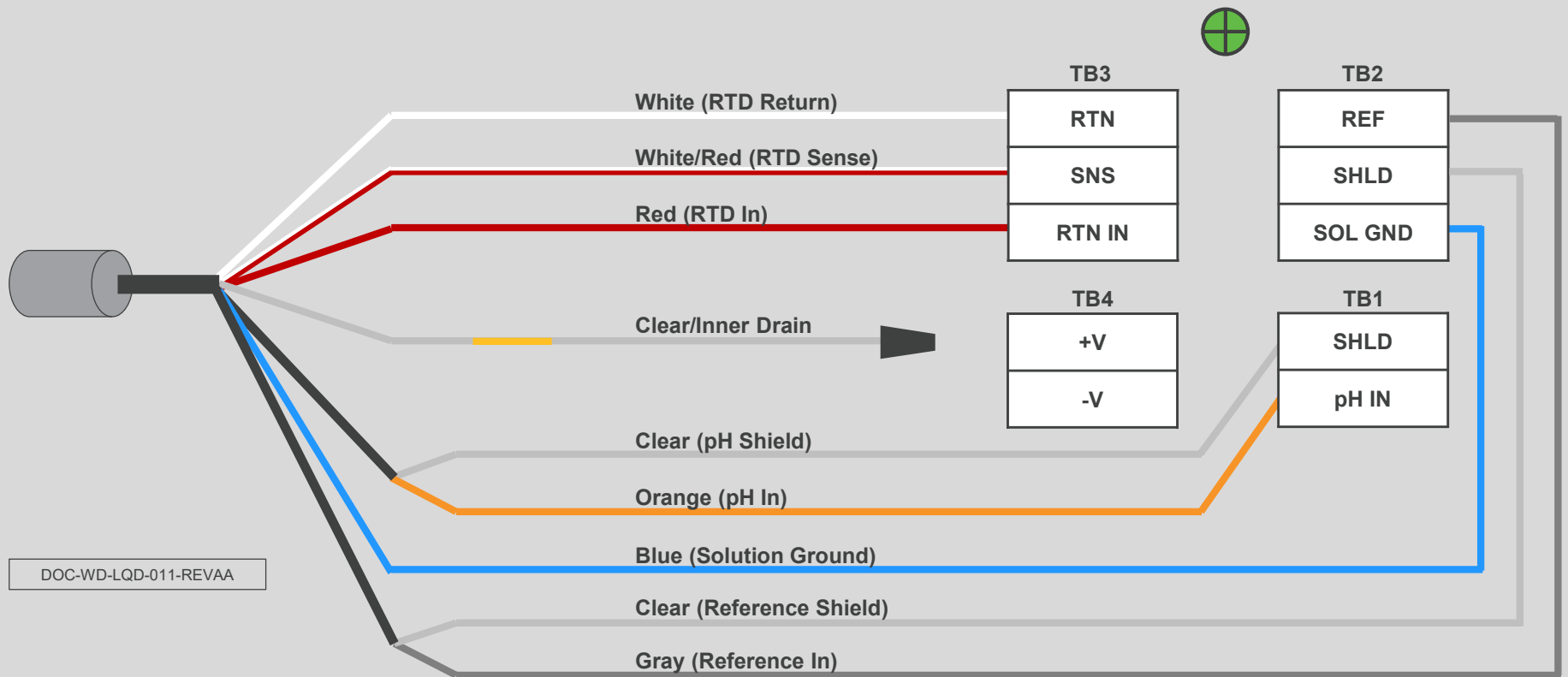

DOC-WD-LQD-011-REVA A

If there is a shrink sleeve on the gray reference wire, remove it before connecting the wire to the terminal.

Rosemount 385+-04 pH/ORP Sensor (Without Preamp) to Rosemount 5081 Transmitter Wiring



If there is a shrink sleeve on the gray reference wire, remove it before connecting the wire to the terminal.

Rosemount Core Preamp pH/ORP Sensors with VP Cable and No Solution Ground

389VP (with preamp)
396VP (with preamp)
398RVP (with preamp)

Rosemount 389VP, 396VP or 398RVP pH/ORP Sensor (With Preamplifier) to Rosemount 56, 1056, 1057, or 1058 Transmitter Wiring

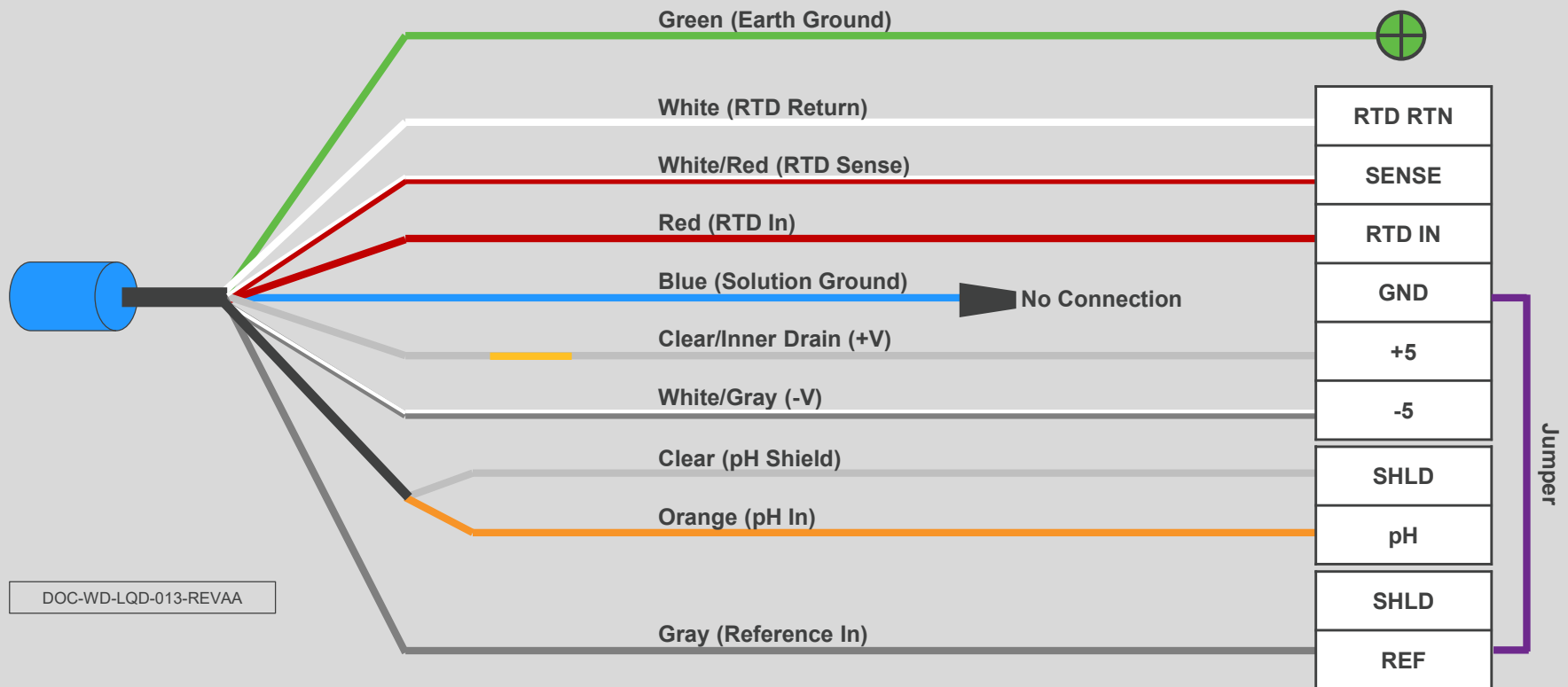

Rosemount 389VP, 396VP or 398RVP pH/ORP Sensor (With Preamplifier) to Rosemount 1066 Transmitter Wiring

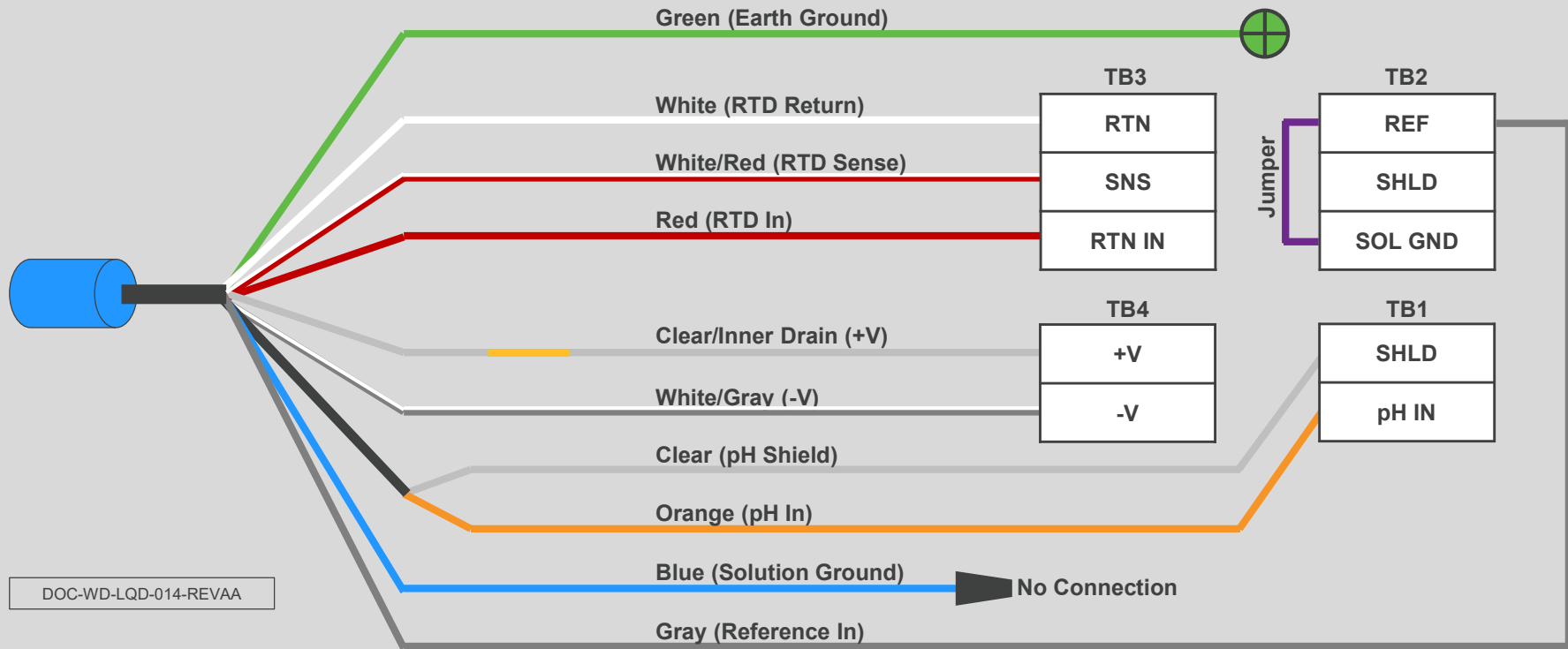

DOC-WD-LQD-014-REVA A

Rosemount 389VP, 396VP or 398RVP pH/ORP Sensor (With Preamplifier) to Rosemount 5081 Transmitter Wiring



Rosemount Core Analog pH/ORP Sensors with VP Cable and No Solution Ground

389VP (without preamp)
396VP (without preamp)
398VP (all options)
398RVP (without preamp)

Rosemount 389VP, 396VP, 398VP, or 398RVP pH/ORP Sensor (Without Preamp) to Rosemount 56, 1056, 1057, or 1058 Transmitter Wiring

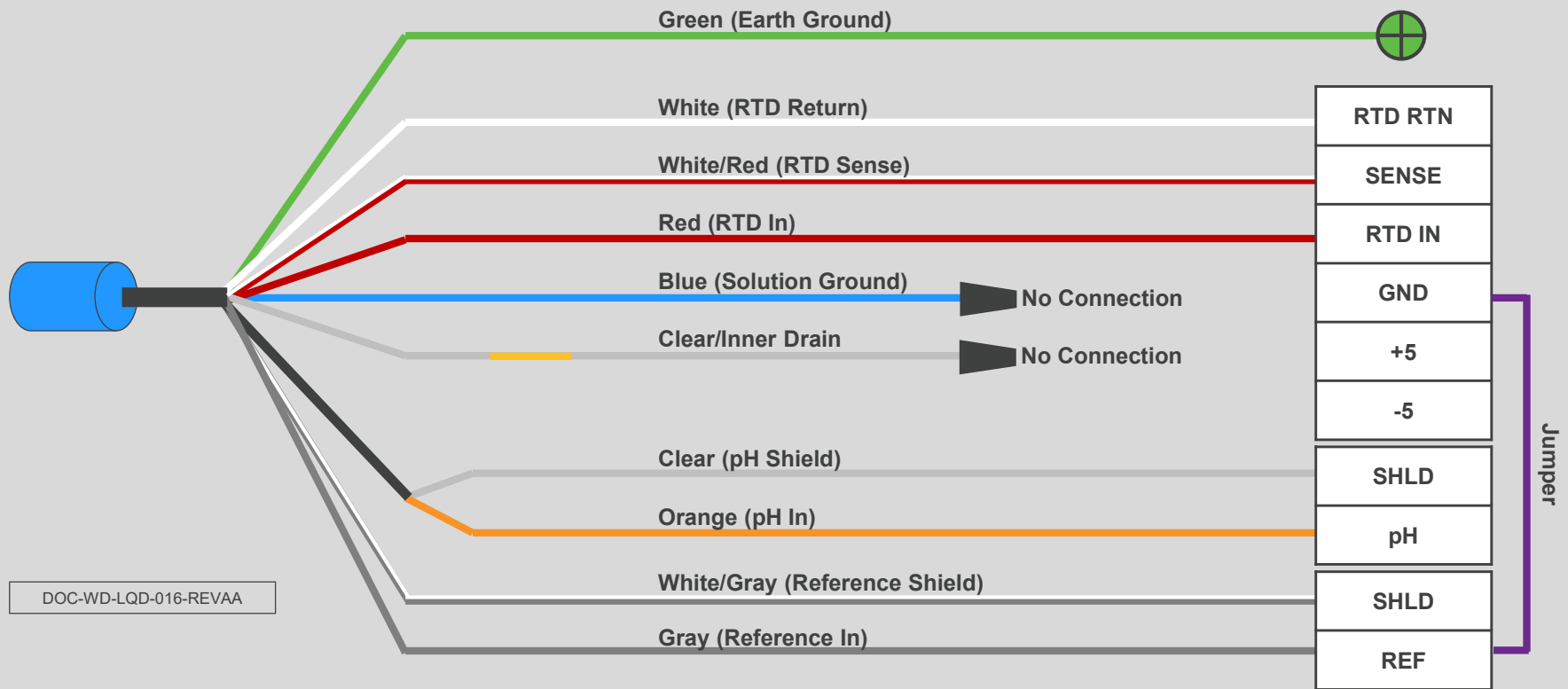

DOC-WD-LQD-016-REVAA

Rosemount 389VP, 396VP, 398VP, or 398RVP pH/ORP Sensor (Without Preamp) to Rosemount 1066 Transmitter Wiring

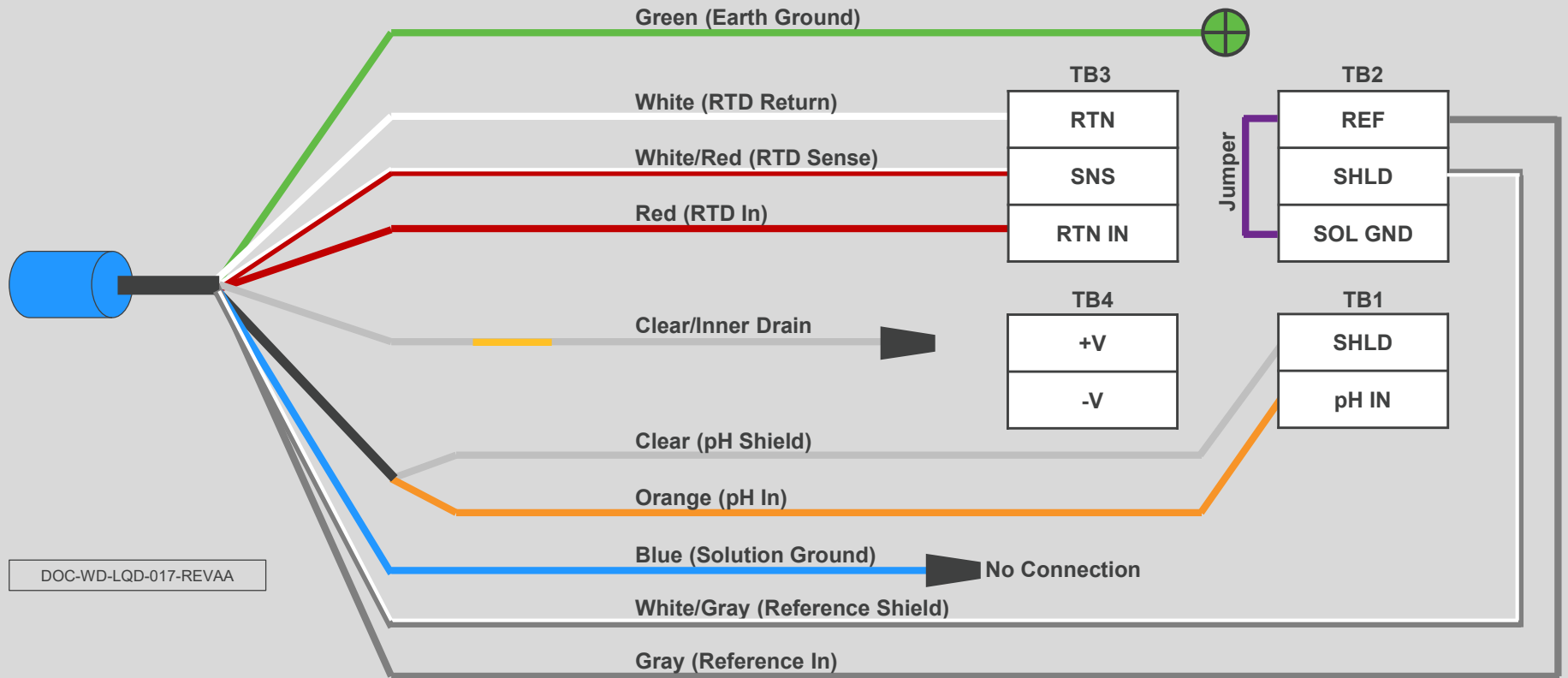

DOC-WD-LQD-017-REVA

Rosemount 389VP, 396VP, 398VP, or 398RVP pH/ORP Sensor (Without Preamplifier) to Rosemount 5081 Transmitter Wiring



Rosemount Core Preamp pH/ORP Sensors with Integral Cable and No Solution Ground

389 (with preamp)

Rosemount 389 (with Preamp) pH/ORP Sensor to Rosemount 56, 1056, 1057, or 1058 Transmitter Wiring



DOC-WD-LQD-019-REVA A

If there is a shrink sleeve on the gray reference wire, remove it before connecting the wire to the terminal.

Rosemount 389 (with Preamp) pH/ORP Sensor to Rosemount 1066 Transmitter Wiring

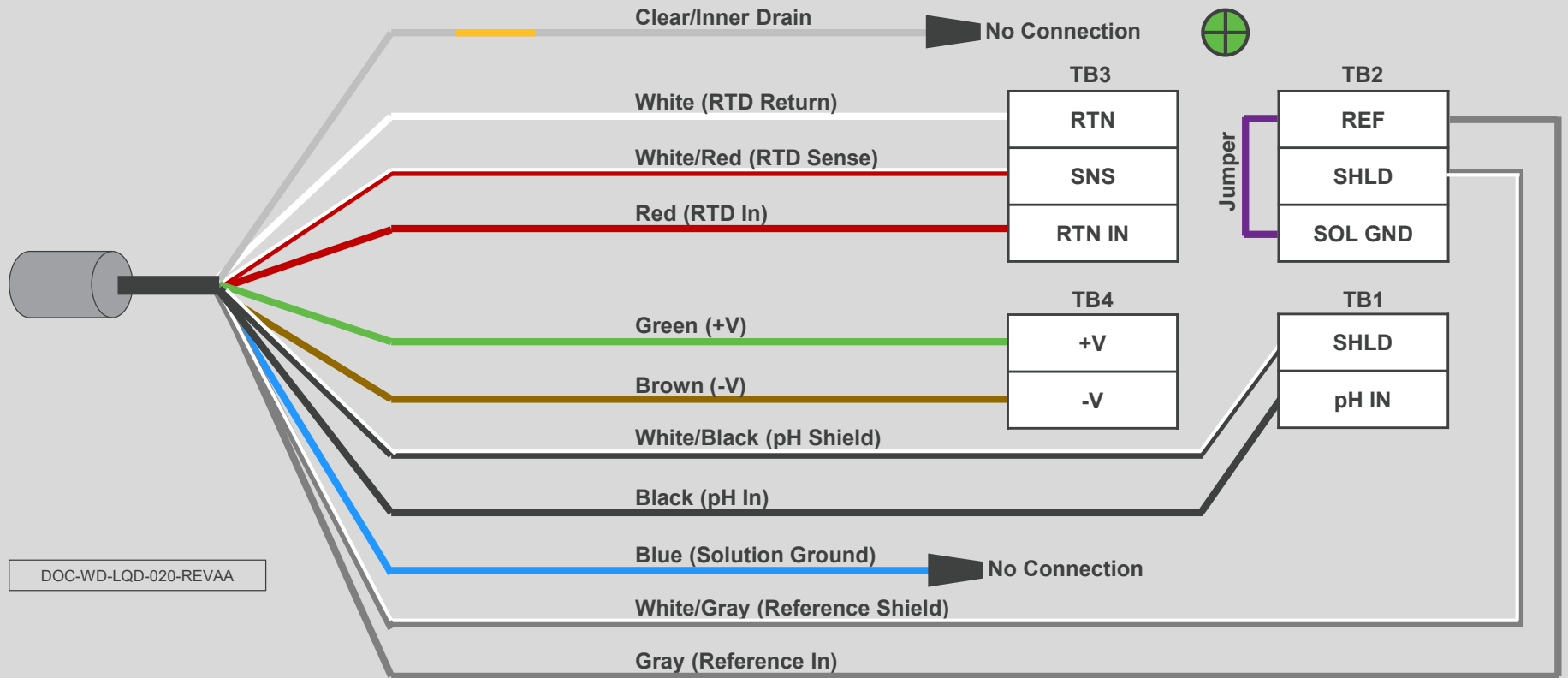

DOC-WD-LQD-020-REVA A

Rosemount 389 (with Preamp) pH/ORP Sensor to Rosemount 5081 Transmitter Wiring



If there is a shrink sleeve on the gray reference wire, remove it before connecting the wire to the terminal.

Rosemount Core Analog pH/ORP Sensors With Integral Cable and No Solution Ground

389 (all options without preamp)
396 (all option codes)
397 (all option codes)
398 (all option codes)
398R (all option codes)

Rosemount 389, 396, 397, 398, or 398R pH/ORP Sensor without Preamp to Rosemount 56, 1056, 1057, or 1058 Transmitter Wiring

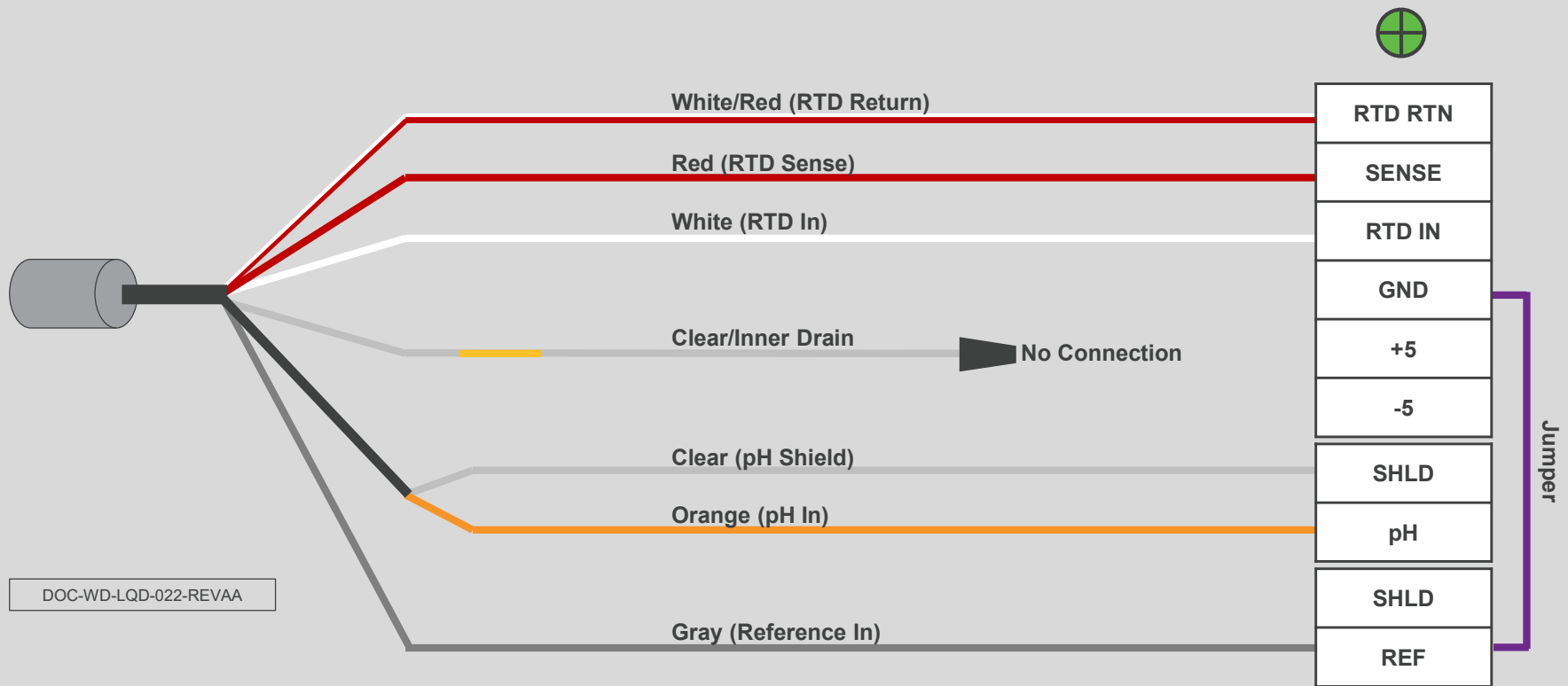

If ground lead is present, terminate it to the green ground screw on the inner enclosure

Rosemount 389, 396, 397, 398, or 398R pH/ORP Sensor without Preamp to Rosemount 1066 Transmitter Wiring

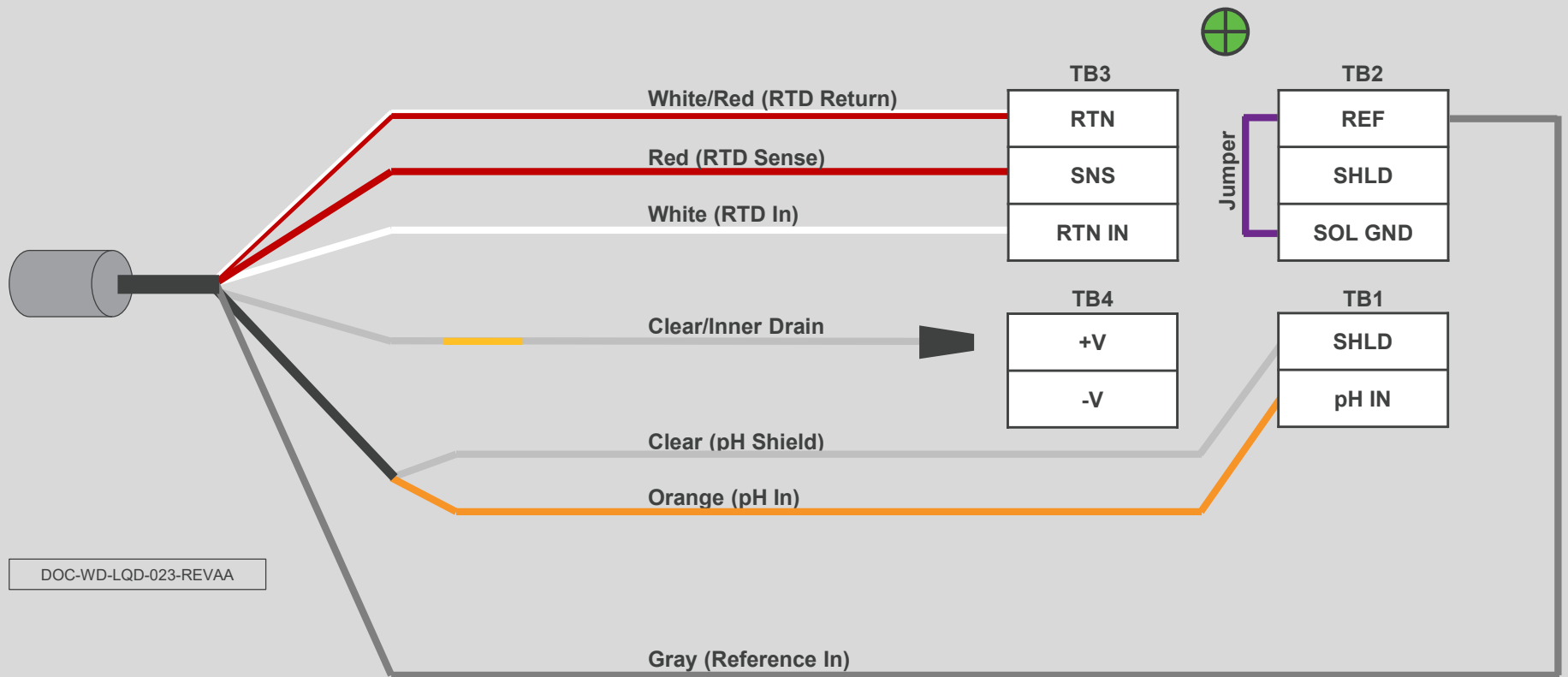

DOC-WD-LQD-023-REVA A

If ground lead is present, terminate it to the green ground screw on the inner enclosure

Rosemount 389, 396, 397, 398, or 398R pH/ORP Sensor without Preamp to Rosemount 5081 Transmitter Wiring



If ground lead is present, terminate it to the green ground screw on the inner enclosure

Rosemount 372 pH Sensor

Rosemount 372-01 pH Sensor (With Preamp) to Rosemount 56, 1056, 1057, or 1058 Transmitter Wiring



It does not matter which red wire is connected to solution ground terminal and which one is connected to reference terminal. Both red wires are connected to each other in the sensor.

Rosemount 372-01 pH Sensor (With Preamp) to Rosemount 1066 Transmitter Wiring



DOC-WD-LQD-026-REVA A

It does not matter which red wire is connected to solution ground terminal and which one is connected to reference terminal. Both red wires are connected to each other in the sensor.

Rosemount 372-01 pH Sensor (With Preamp) to Rosemount 5081 Transmitter Wiring

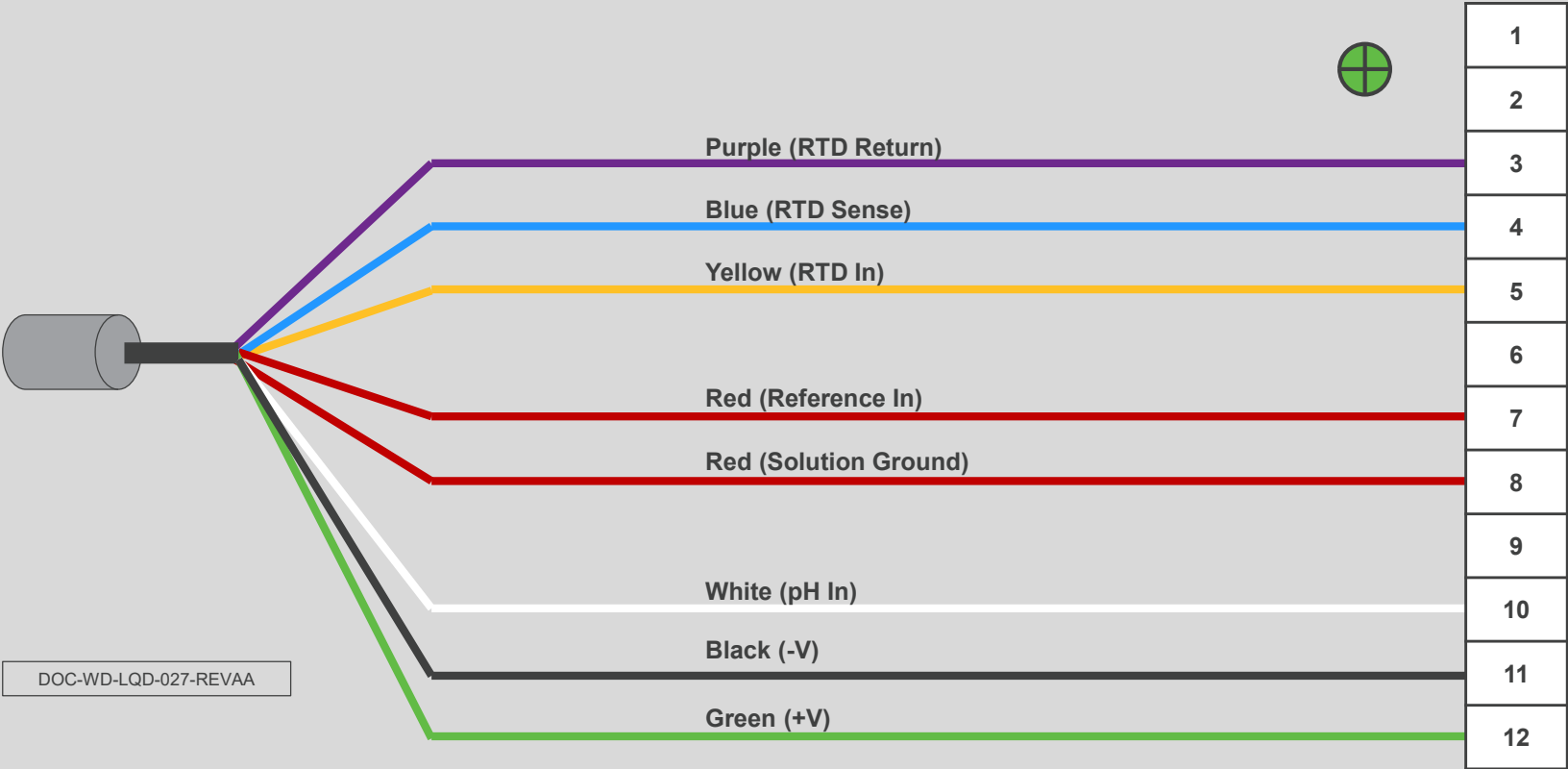

It does not matter which red wire is connected to solution ground terminal and which one is connected to reference terminal. Both red wires are connected to each other in the sensor.

Rosemount 372-02 pH Sensor (Without Pre-amplifier) to Rosemount 56, 1056, 1057, or 1058 Transmitter Wiring

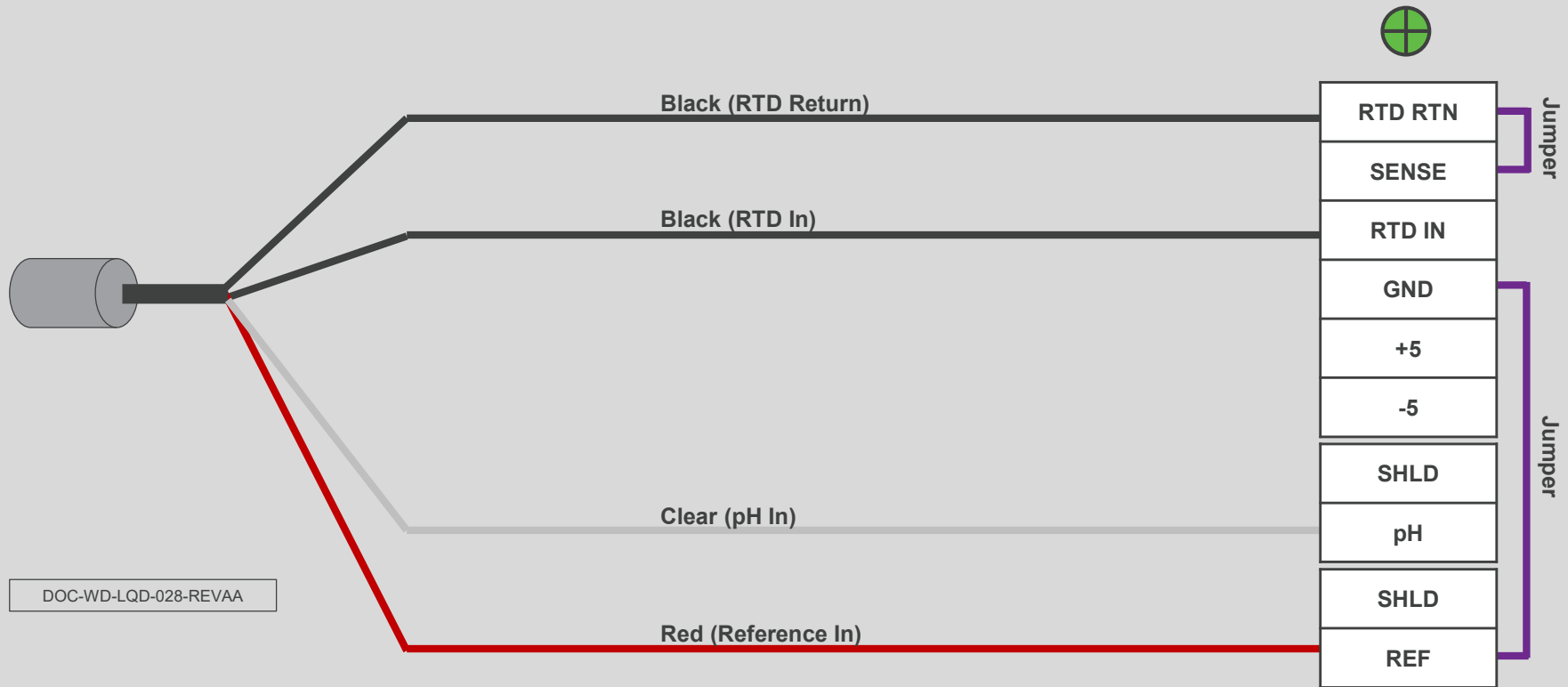

It does not matter which black wire is connected to RTD Return and which one is connected to RTD In. Both black wires are connected to each other in the sensor.

Rosemount 372-02 pH Sensor (Without Pre-amplifier) to Rosemount 1066 Transmitter Wiring

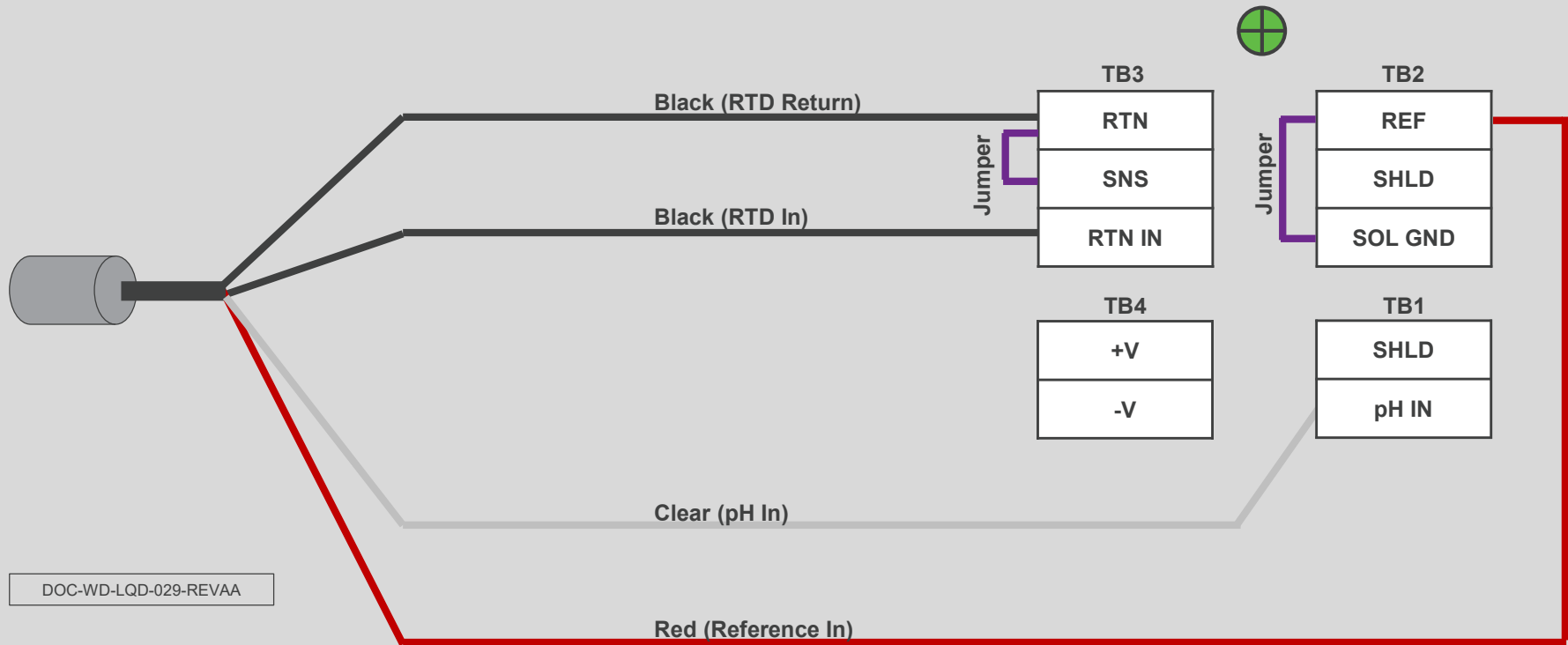

DOC-WD-LQD-029-REVA A

It does not matter which black wire is connected to RTD Return and which one is connected to RTD In. Both black wires are connected to each other in the sensor.

Rosemount 372-02 pH Sensor (Without Pre-amplifier) to Rosemount 5081 Transmitter Wiring

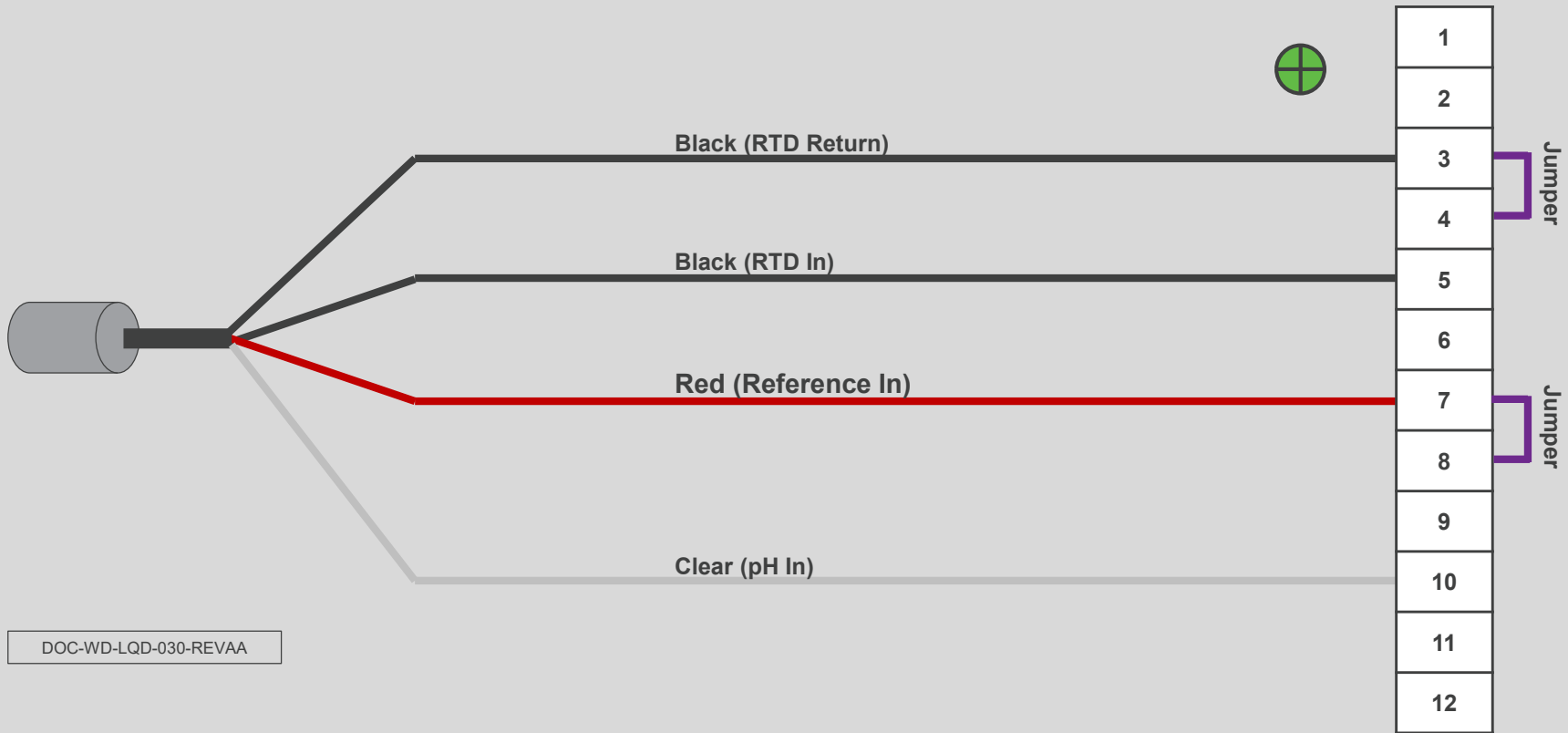

It does not matter which black wire is connected to RTD Return and which one is connected to RTD In. Both black wires are connected to each other in the sensor.

Hx338+ pH Sensor

Rosemount Hx338+ pH Sensor to Rosemount 56, 1056, 1057, or 1058 Transmitter Wiring

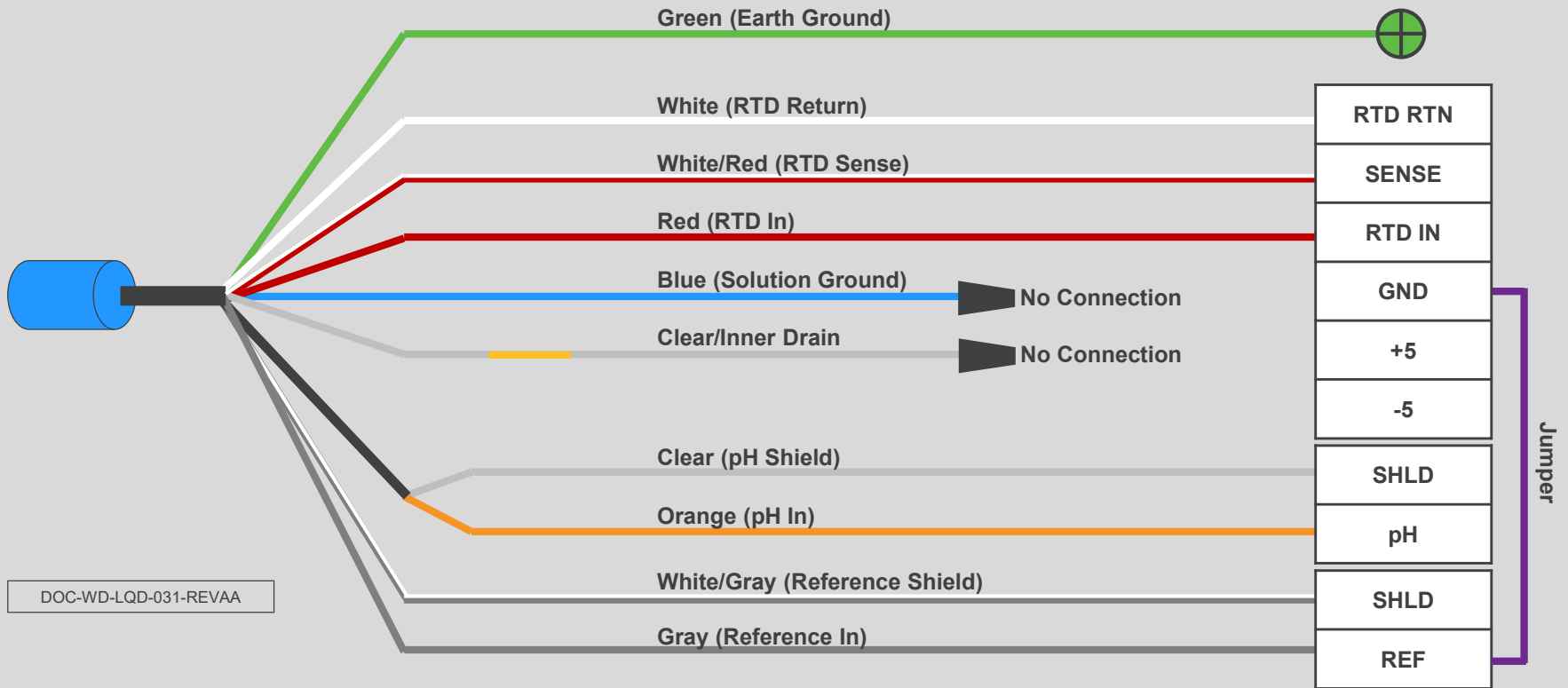

Rosemount Hx338+ pH Sensor to Rosemount 1066 Transmitter Wiring

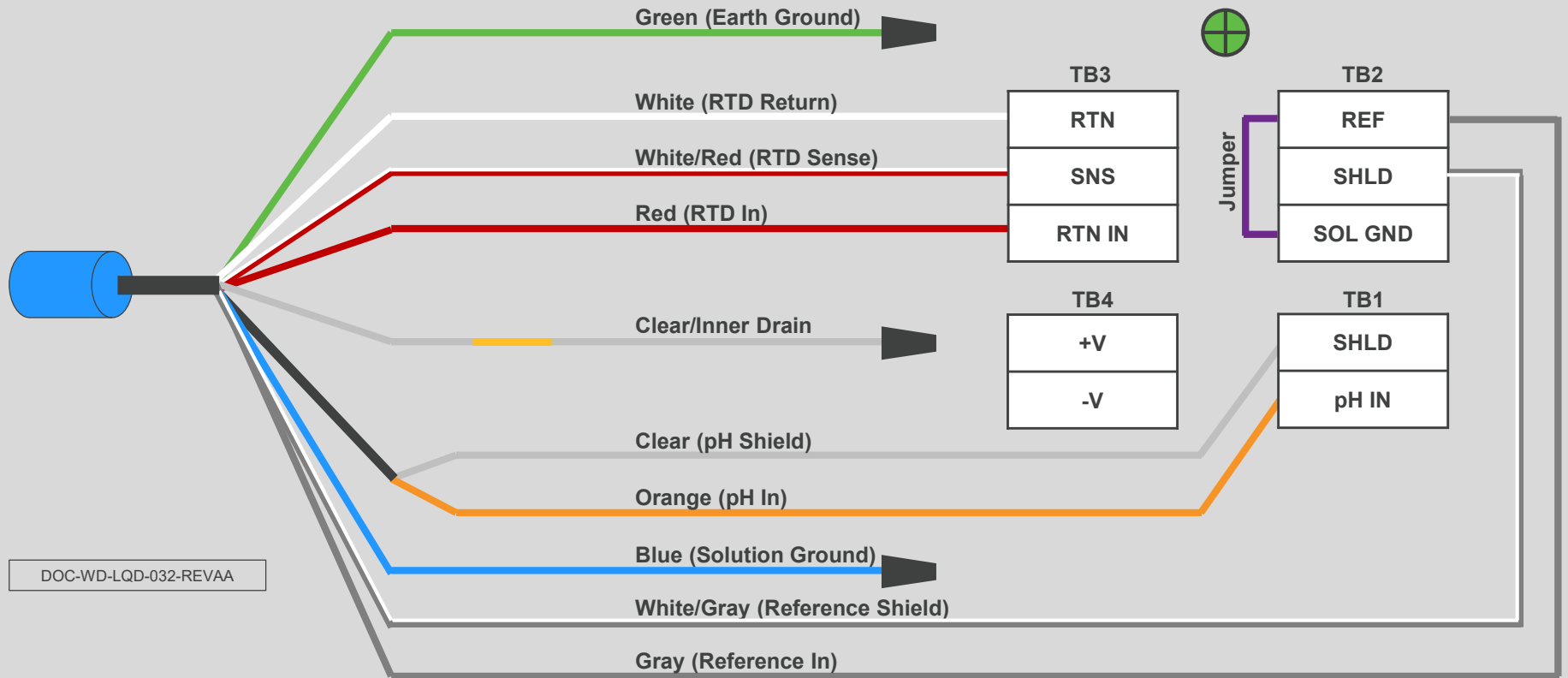

DOC-WD-LQD-032-REVA A

Rosemount Hx338+ pH Sensor to Rosemount 5081 Transmitter Wiring



Rosemount RBI pH/ORP Sensor

Rosemount RBI pH/ORP Sensor (Integral Cable) to Rosemount 56, 1056, 1057, or 1058 Transmitter Wiring

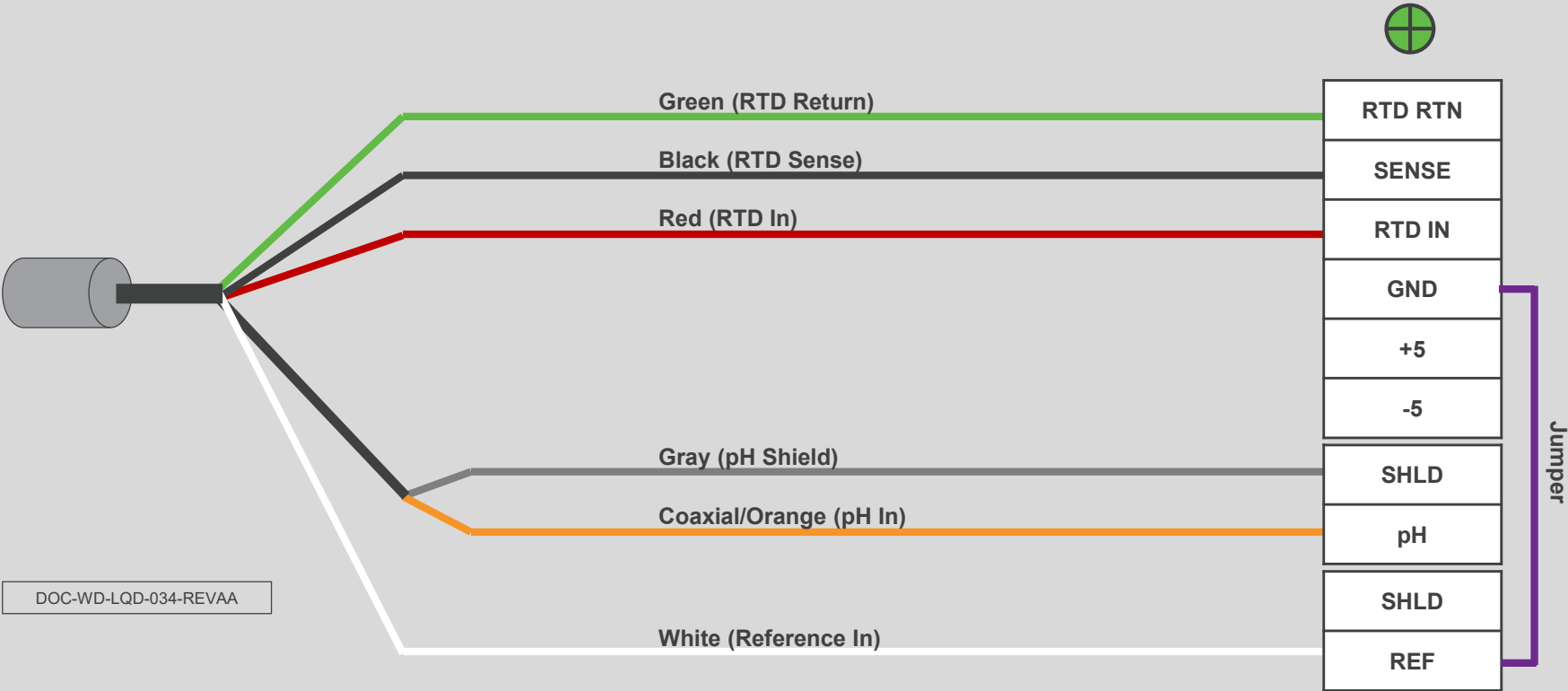

DOC-WD-LQD-034-REVA

Rosemount RBI pH/ORP Sensor (Integral Cable) to Rosemount 1066 Transmitter Wiring

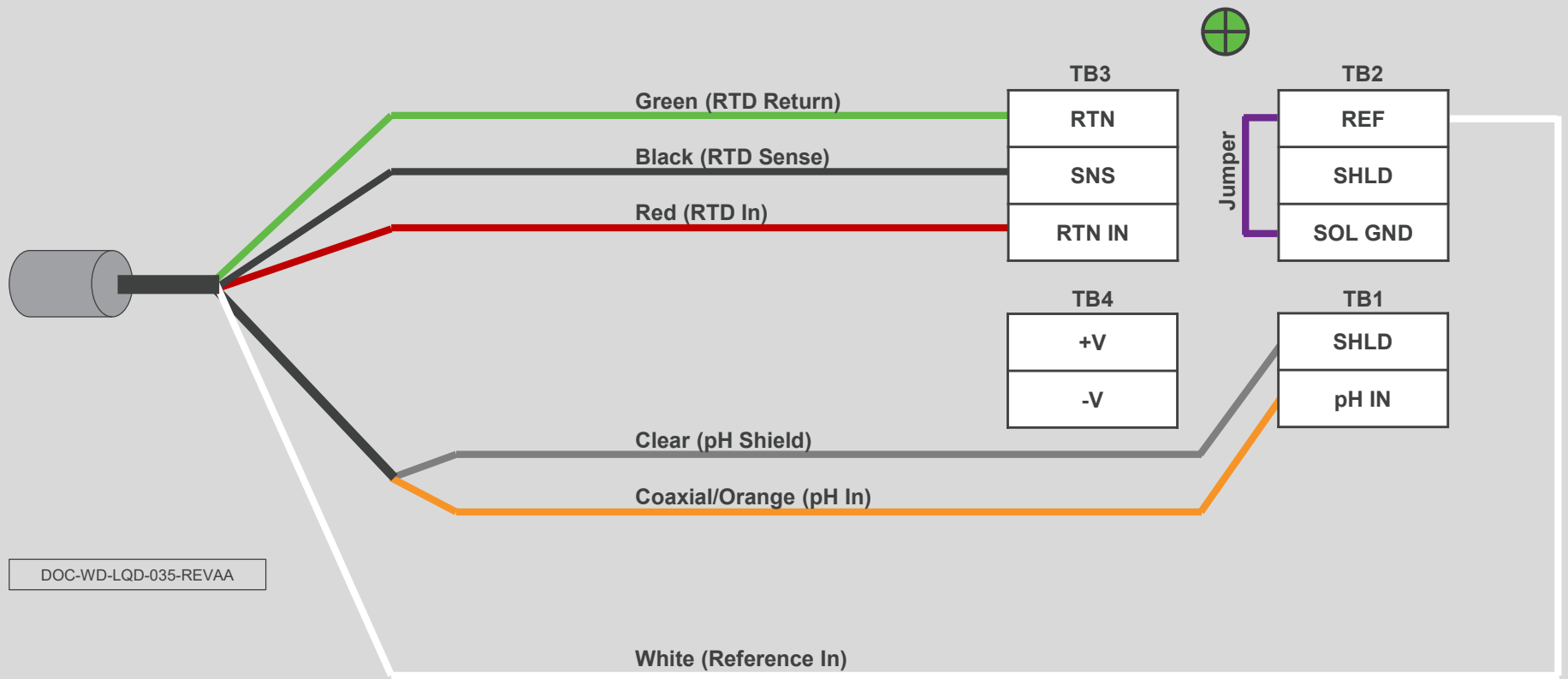

DOC-WD-LQD-035-REVA

Rosemount RBI pH/ORP Sensor (Integral Cable) to Rosemount 5081 Transmitter Wiring



Rosemount RBI pH/ORP Sensor (VP Cable) to Rosemount 56, 1056, 1057, or 1058 Transmitter Wiring

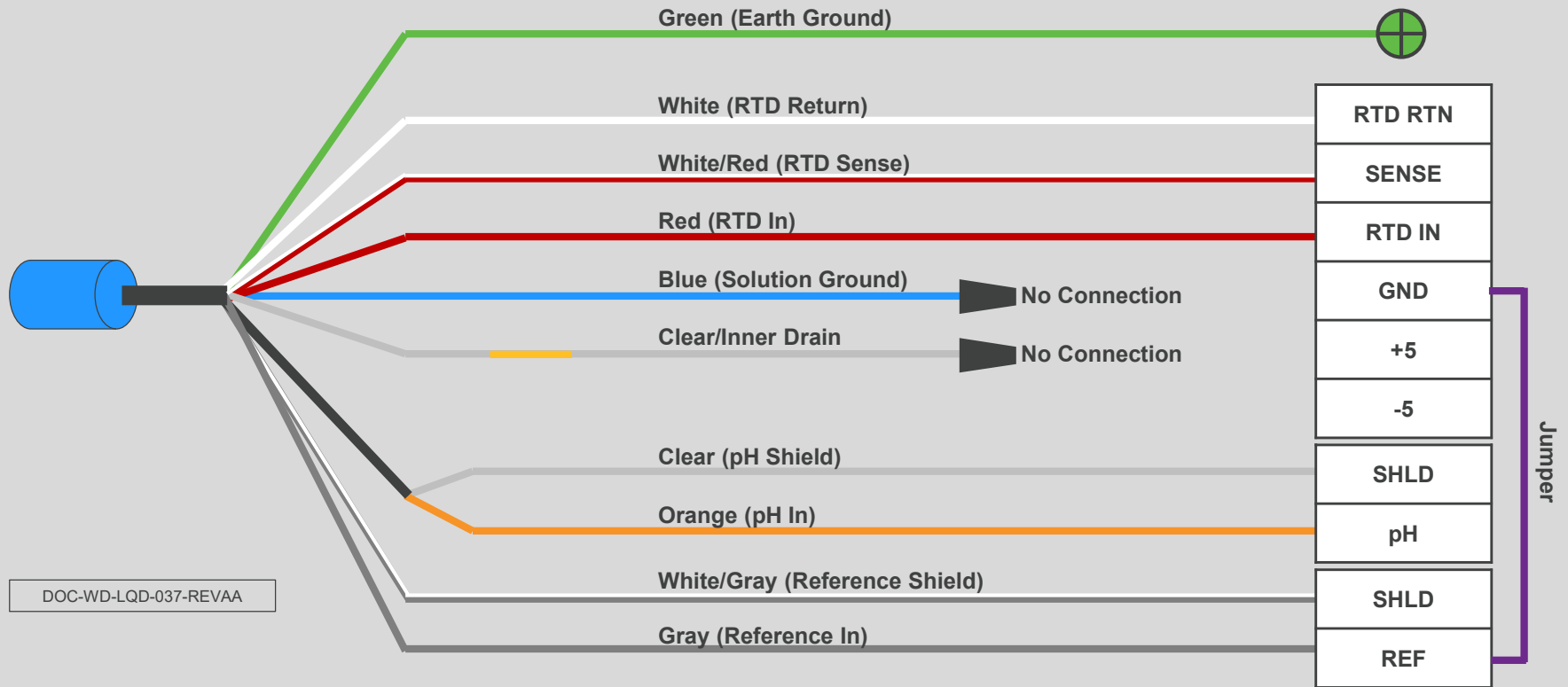

Rosemount RBI pH/ORP Sensor (VP Cable) to Rosemount 1066 Transmitter Wiring

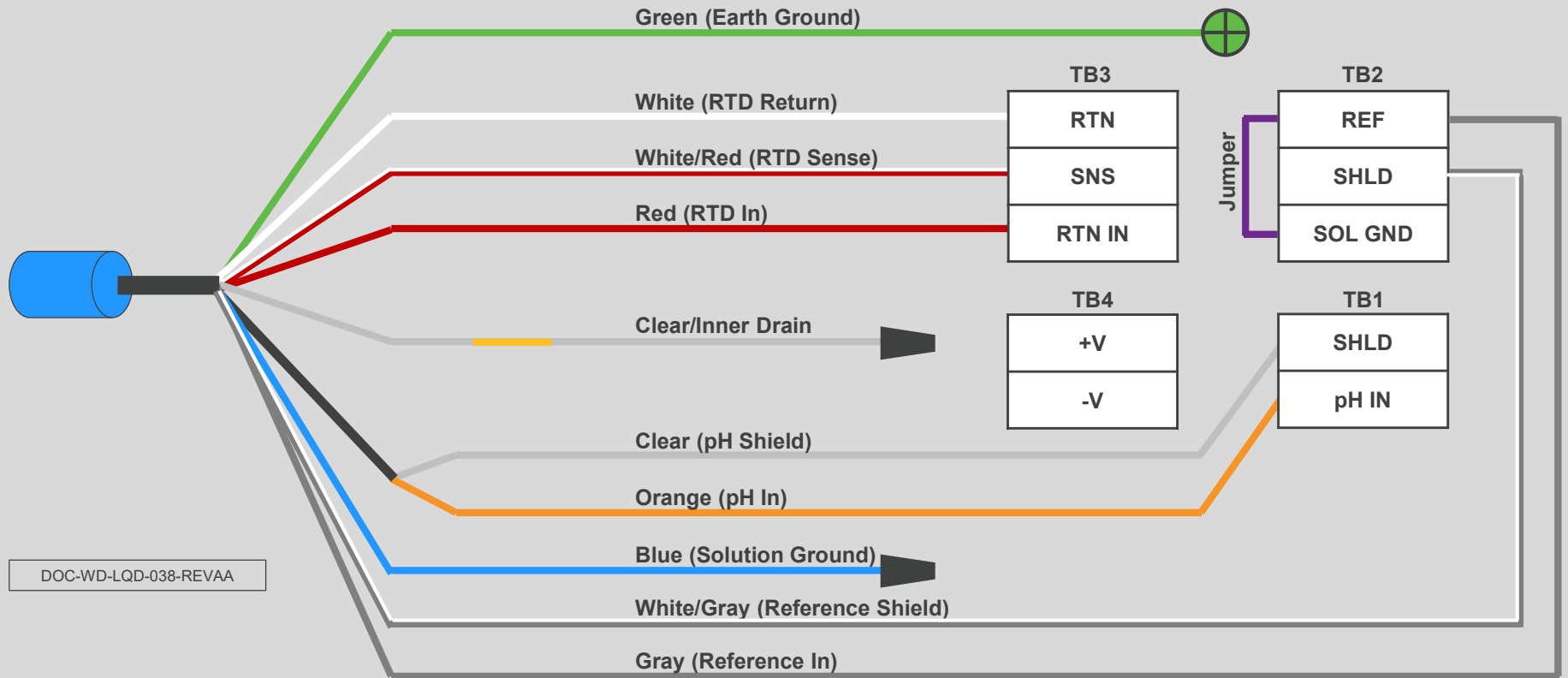

DOC-WD-LQD-038-REVA A

Rosemount RBI pH/ORP Sensor (VP Cable) to Rosemount 5081 Transmitter Wiring



DOC-WD-LQD-039-REVA A

pH Sensor with Remote Junction Box

Rosemount pH/ORP Sensor (Without Preamp) Wiring to Junction Box PN 23555-00 and 56, 1056, 1057, 1058, or 1066 Transmitter

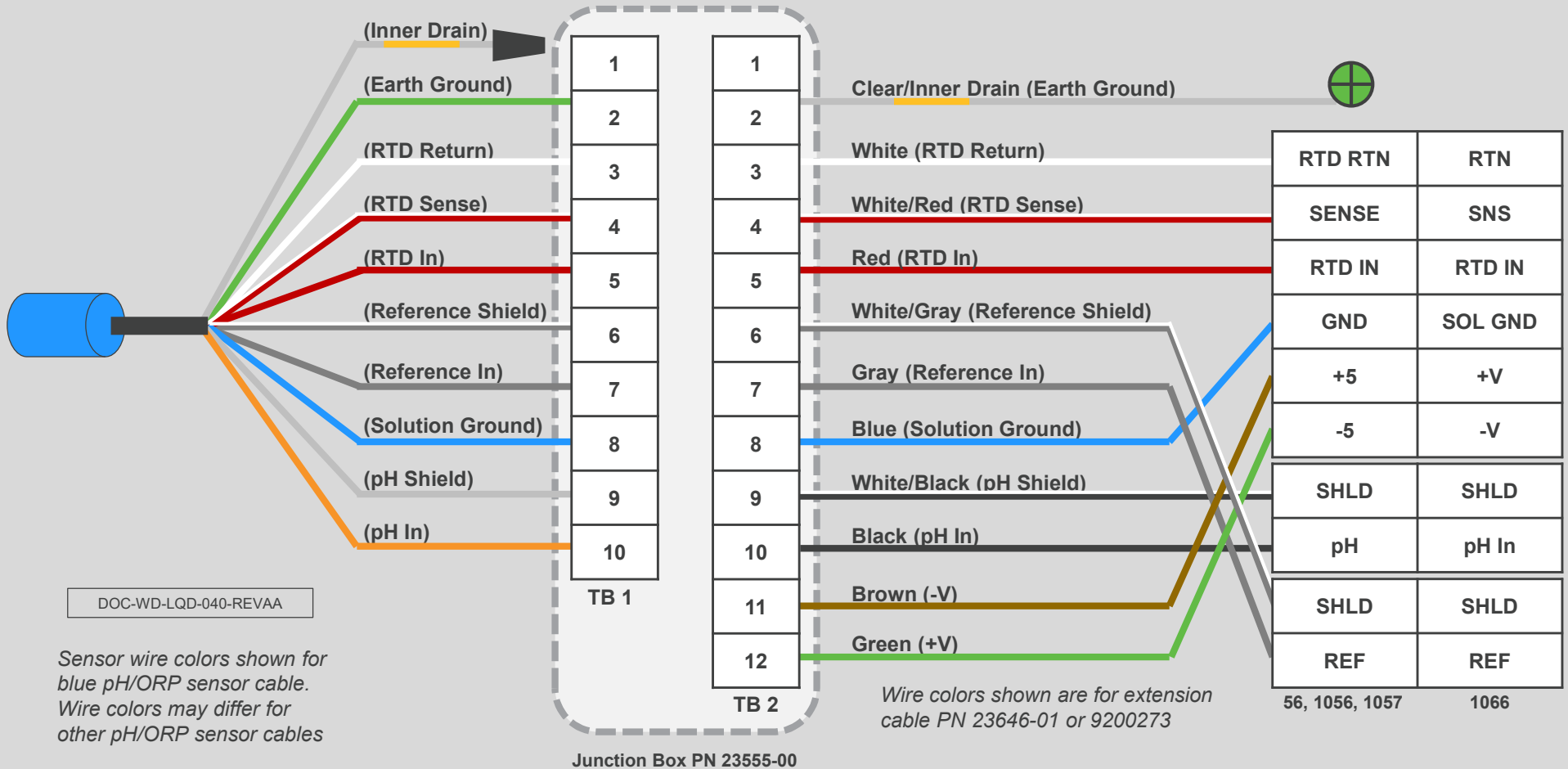

Rosemount pH/ORP Sensor (Without Preamp) Wiring To Junction Box PN 23555-00 and 5081 Transmitter

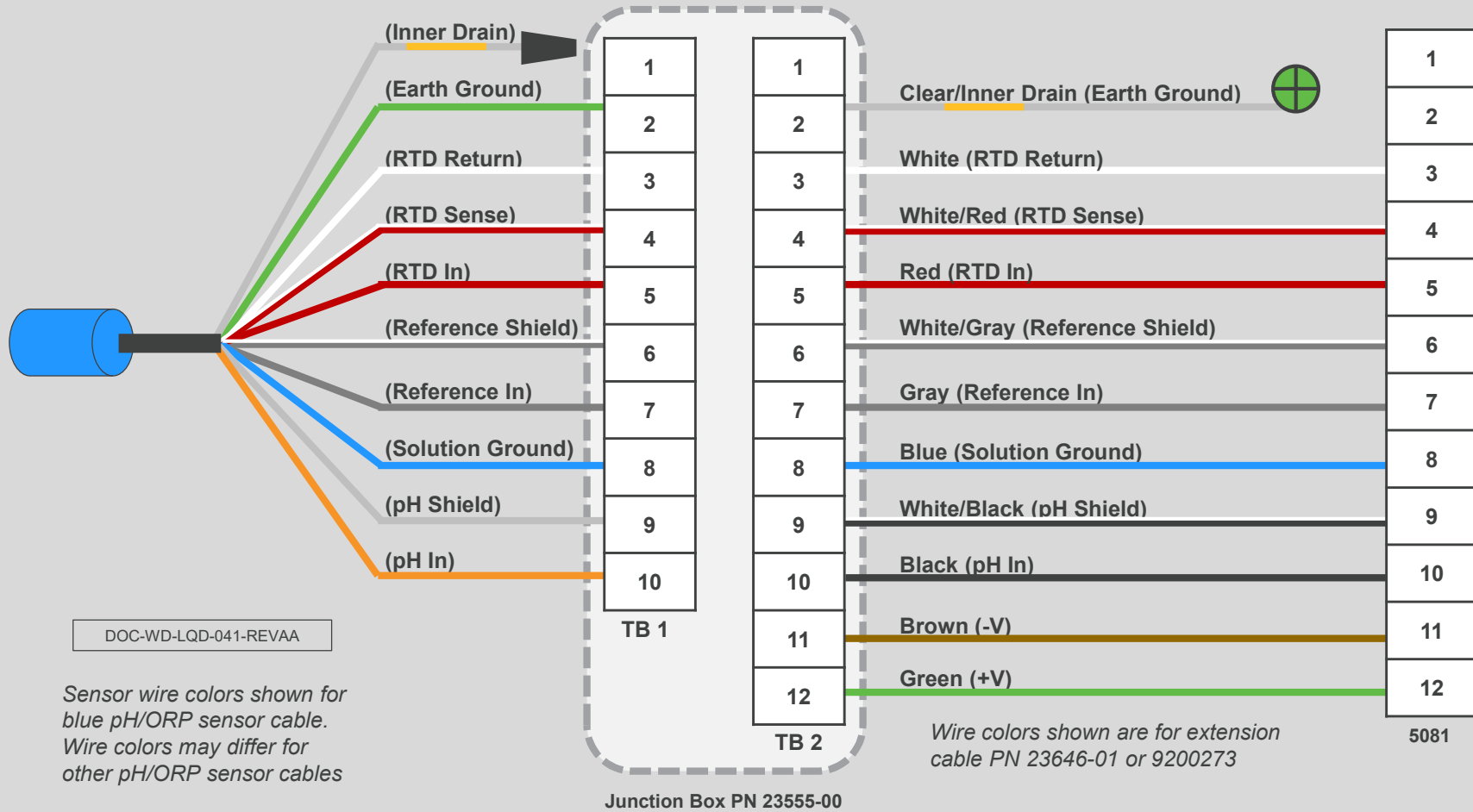

Rosemount pH/ORP Sensor (With Preamp) Wiring To Junction Box PN 23550-00 and 56, 1056, 1057, 1058 or 1066 Transmitter

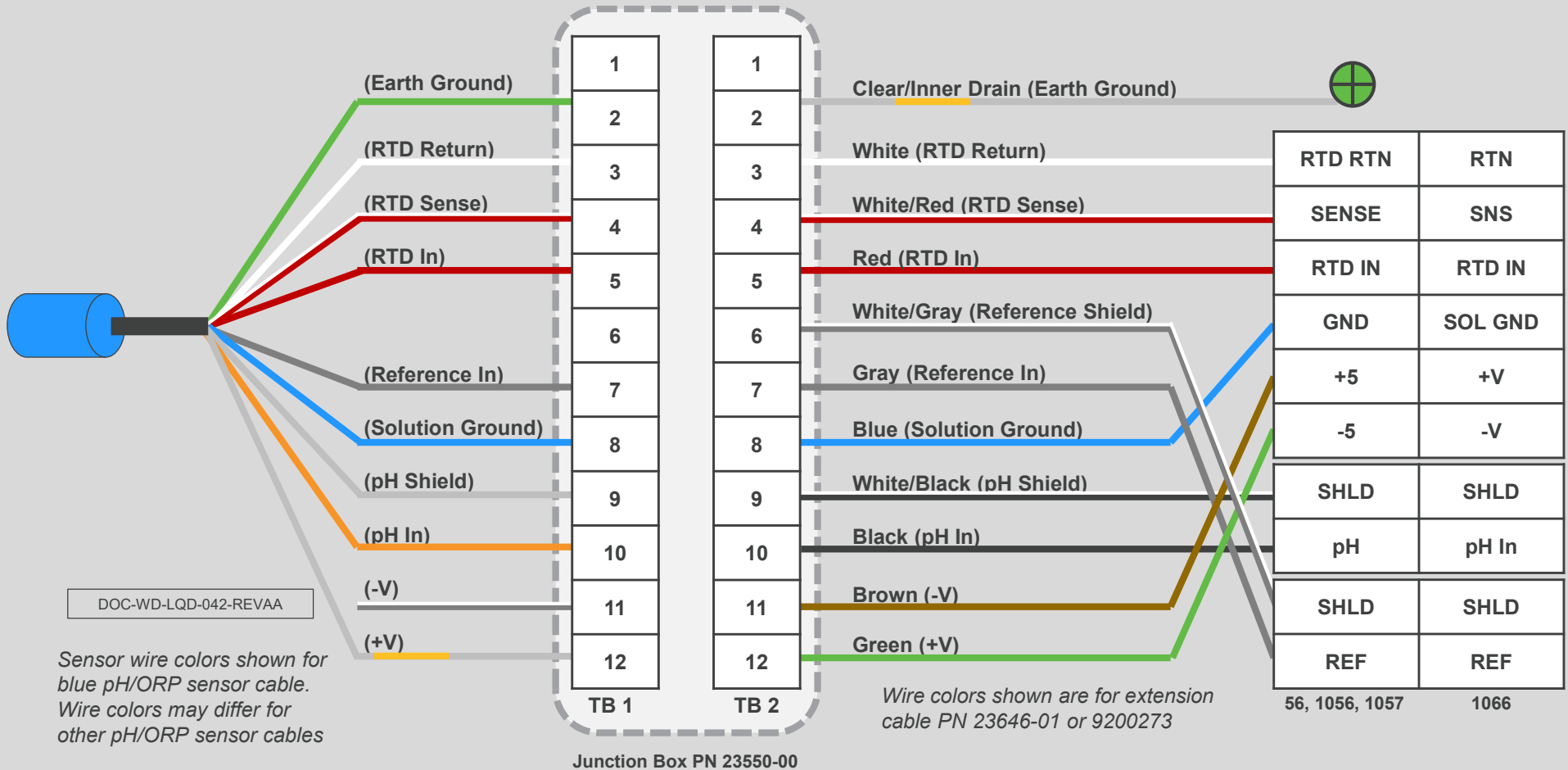

Rosemount pH/ORP (With Preamplifier) Sensor Wiring To Junction Box PN 23550-00 and 5081 Transmitter

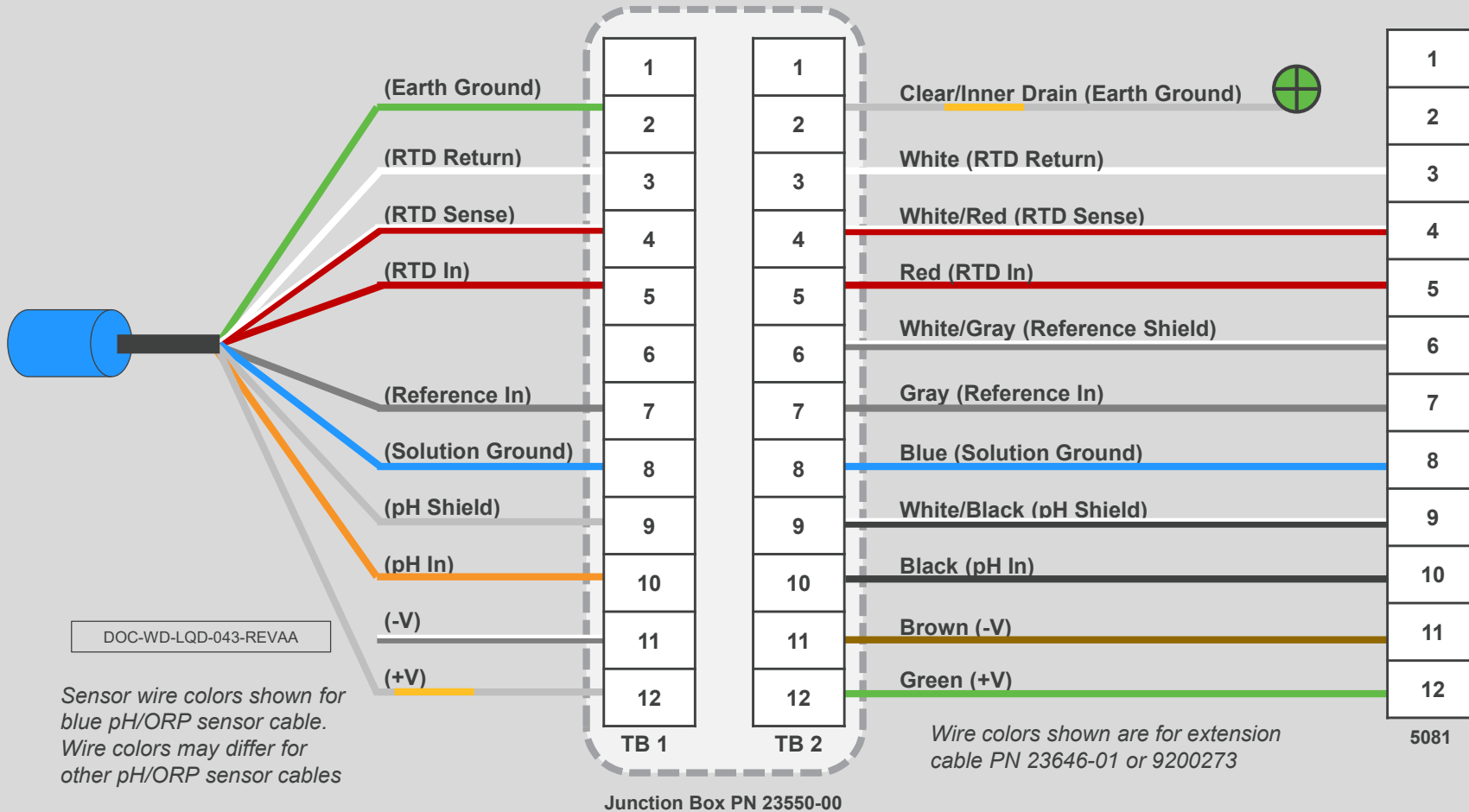

Conductivity Sensors

Rosemount 2 Electrode Conductivity Sensors

Rosemount 400, 400VP, 402, 402VP, 403, 403VP, 404, 140, 141, or 142 Conductivity Sensor to Rosemount 56, 1056, 1057, or 1058 Transmitter Wiring

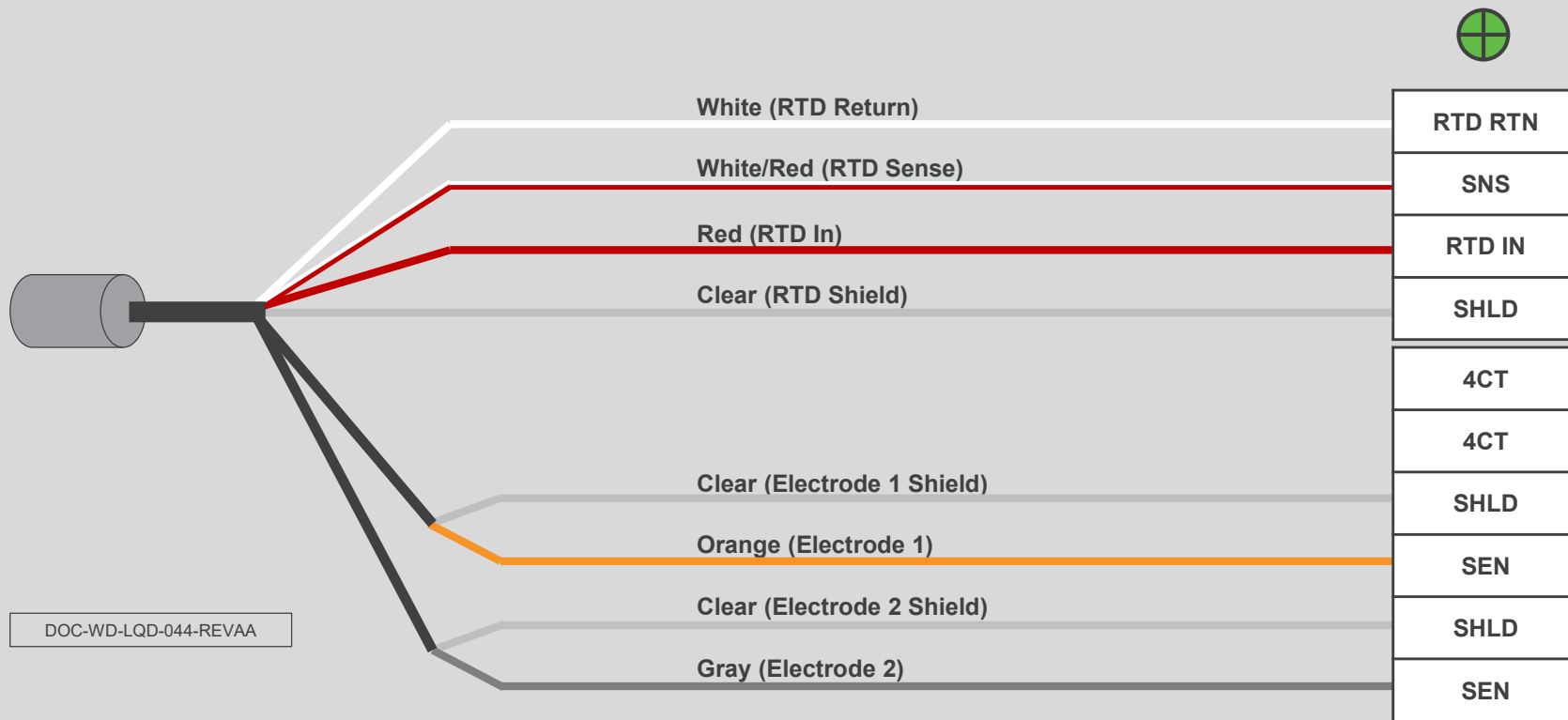

Rosemount 400, 400VP, 402, 402VP, 403, 403VP, 404, 140, 141, or 142 Conductivity Sensor to Rosemount 1066 Transmitter Wiring

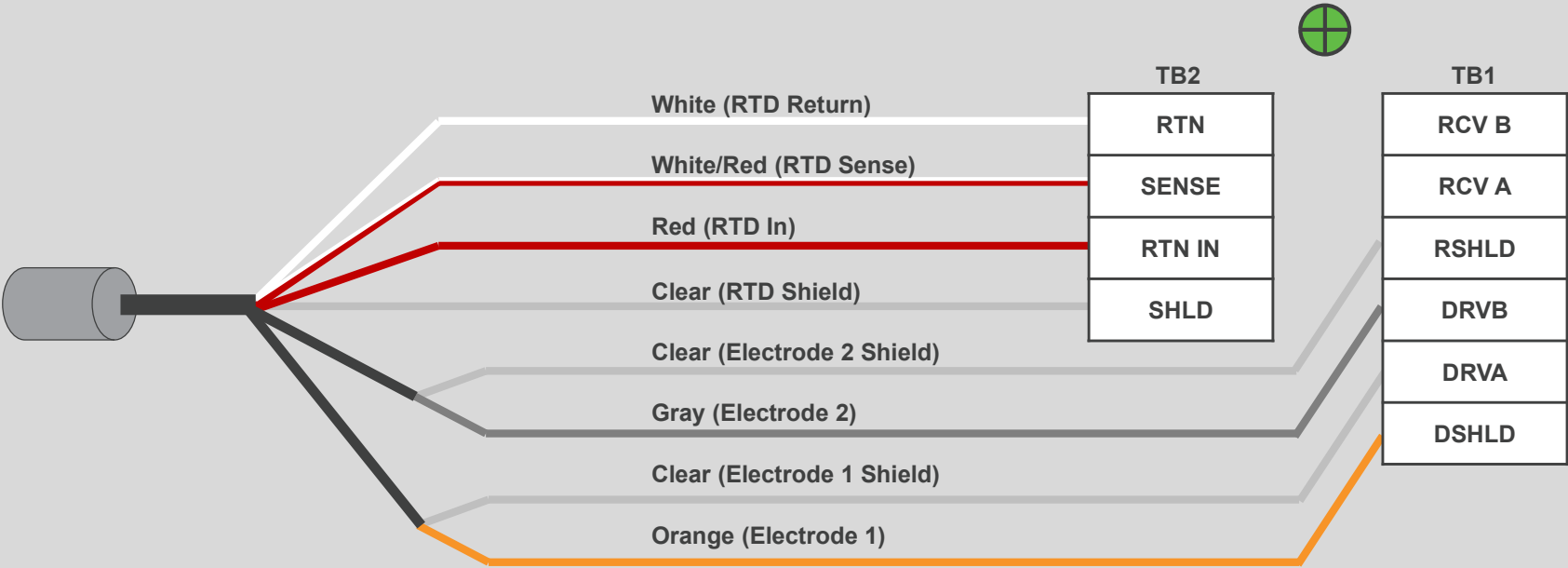

DOC-WD-LQD-045-REVA A

Rosemount 400, 400VP, 402, 402VP, 403, 403VP, 404, 140, 141, or 142 Conductivity Sensor to Rosemount 5081 Transmitter Wiring

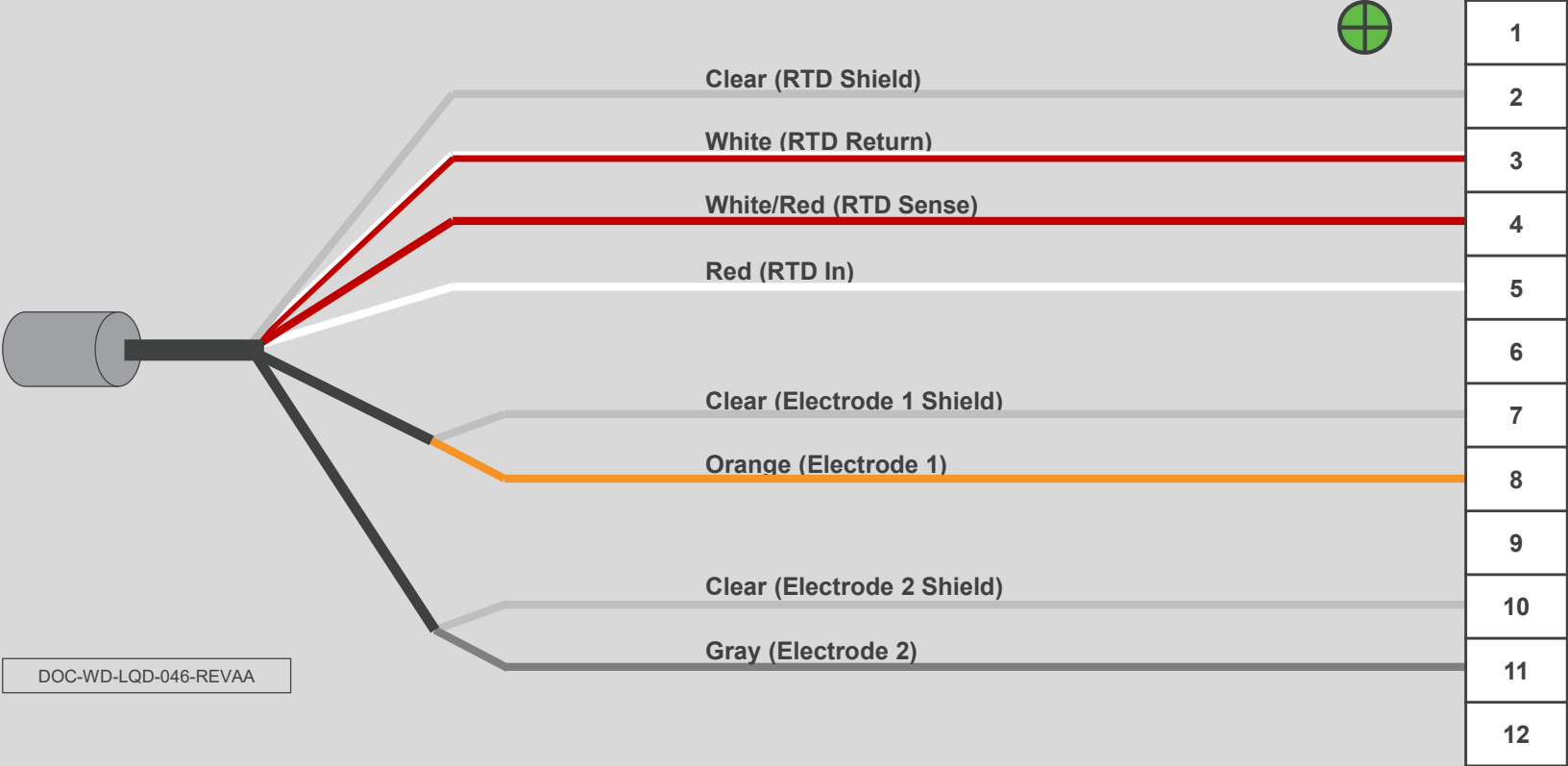

DOC-WD-LQD-046-REVA A

Rosemount 410VP Conductivity Sensor

Rosemount 410VP Conductivity Sensor to Rosemount 56, 1056, 1057, or 1058 Transmitter Wiring

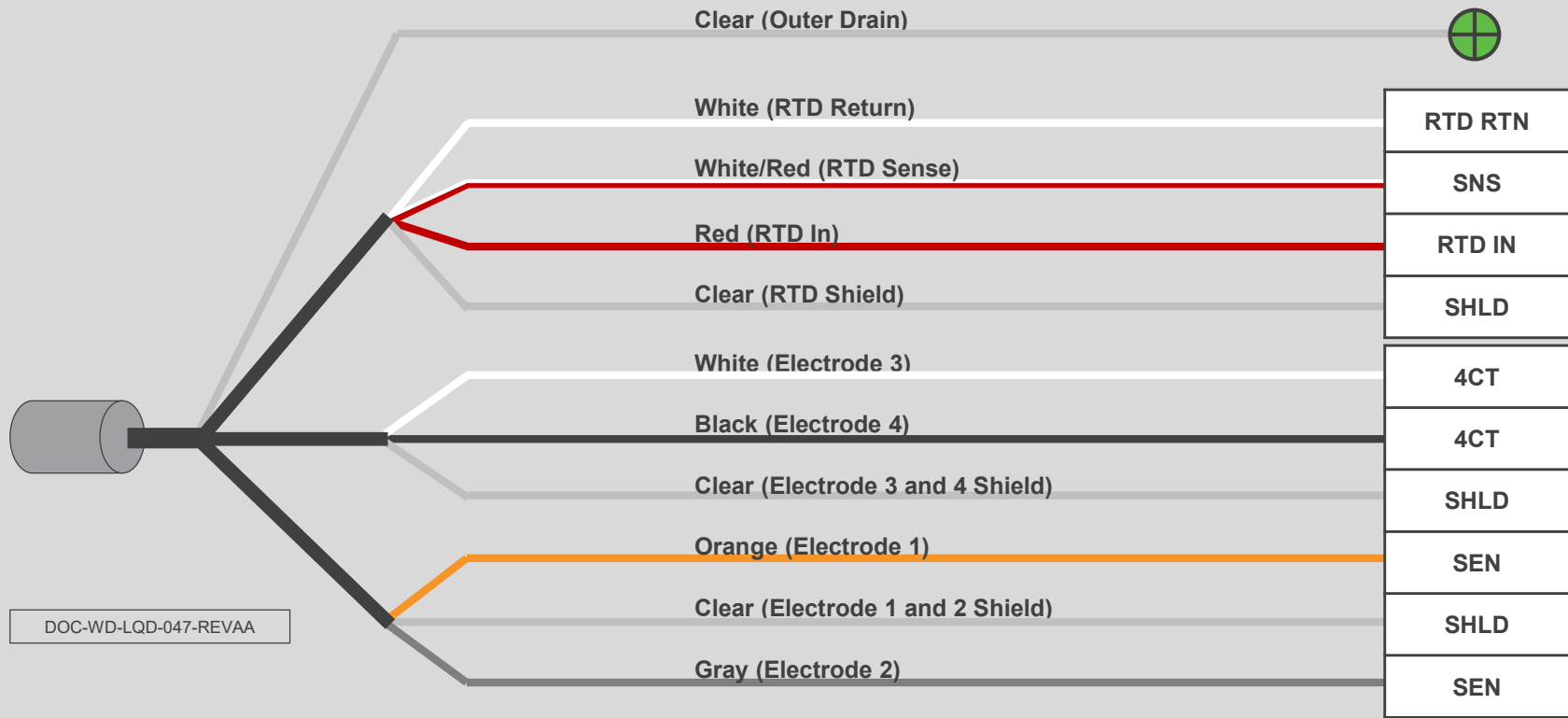

Current is injected through the gray and orange wires. Voltage is measured across the white and black wires.

Rosemount 410VP Conductivity Sensor to Rosemount 1066 Transmitter Wiring

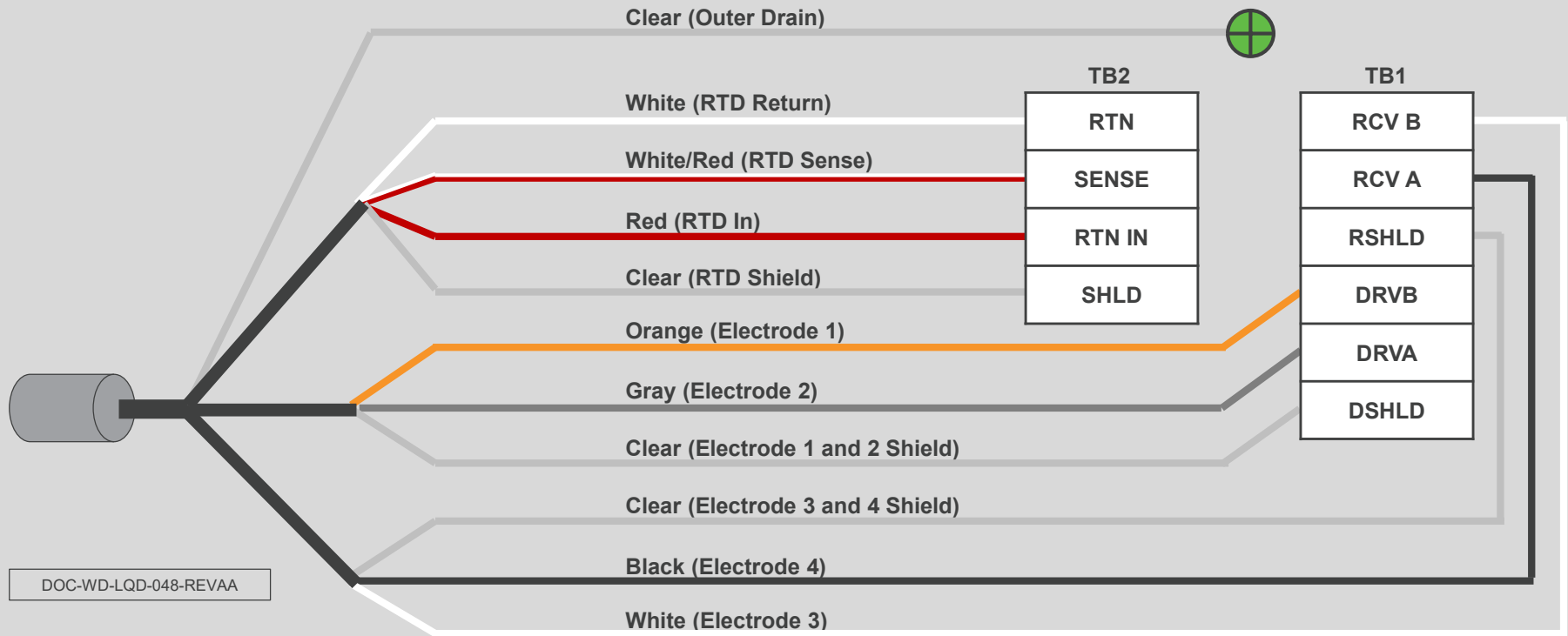

Rosemount Toroidal Conductivity Sensors with Shielded Cable

225-56 (with shielded cable)

226-56 (with shielded cable)

228-56 (with shielded cable)

242 (with extension cable PN 23909-00)

245 (with extension cable PN 23909-00)

Rosemount 225-56, 226-56, 228-56, 242, or 245 Conductivity Sensor (Shielded Cable) to Rosemount 56, 1056, 1057, or 1058 Transmitter Wiring



DOC-WD-LQD-049-REVA A

Clear outer shield wire is present in high temperature sensor options only

Rosemount 225-56, 226-56, 228-56, 242, or 245 Conductivity Sensor (Shielded Cable) to Rosemount 1066 Transmitter Wiring



Clear outer shield wire is present in high temperature sensor options only

Rosemount 225-56, 226-56, 228-56, 242, or 245 Conductivity Sensor (Shielded Cable) to Rosemount 56, 1056, 1057, Transmitter Wiring

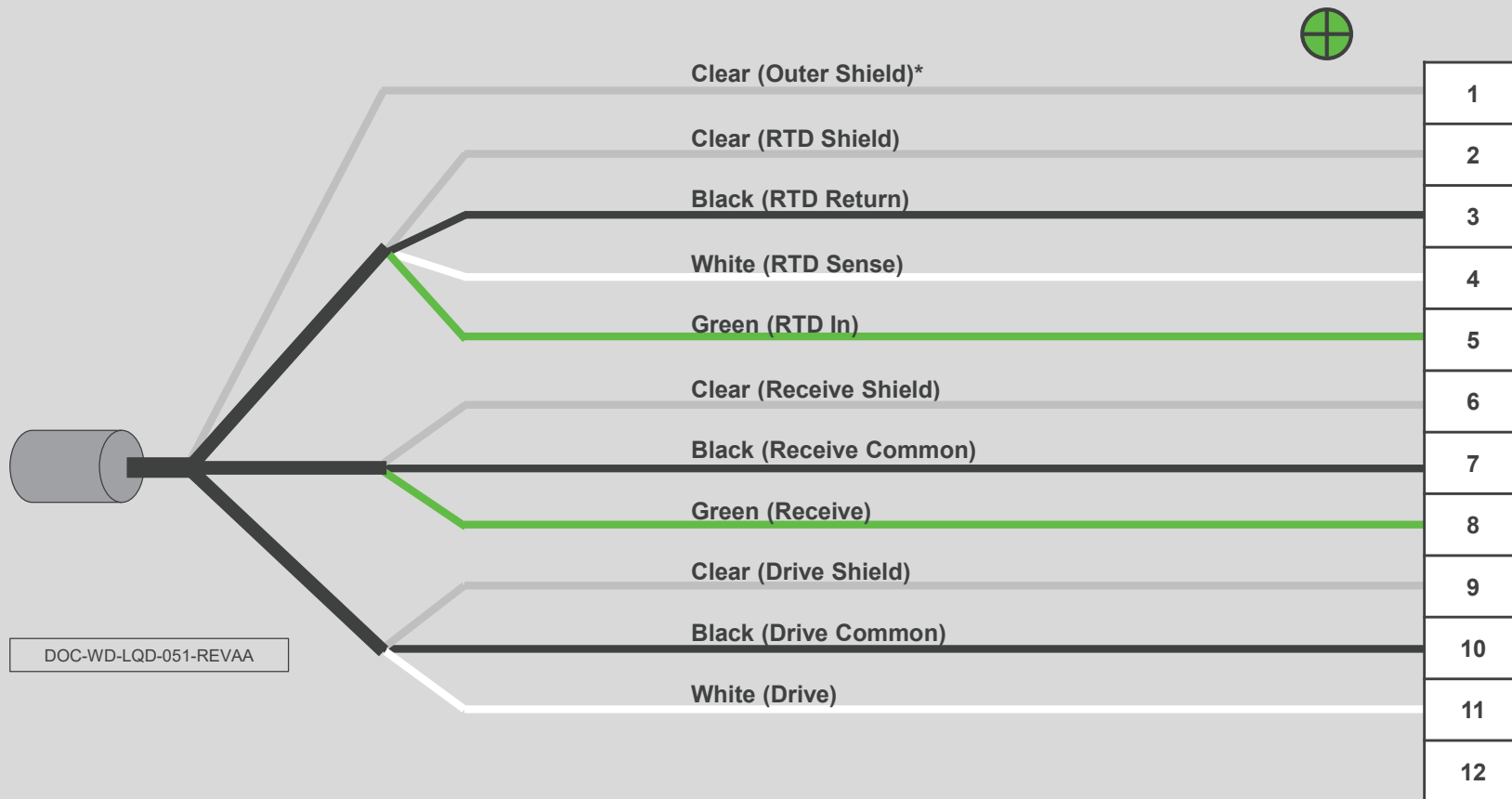

Clear outer shield wire is present in high temperature sensor options only

Rosemount Toroidal Conductivity Sensors with Unshielded Cable

225-54 (with unshielded cable)
226-54 (with unshielded cable)
228-54 (with unshielded cable)
222 (all options)

Rosemount 225-54, 226-54, 228-54, or 222 Conductivity Sensor (Unshielded Cable) to Rosemount 56, 1056, 1057, or 1058 Transmitter Wiring

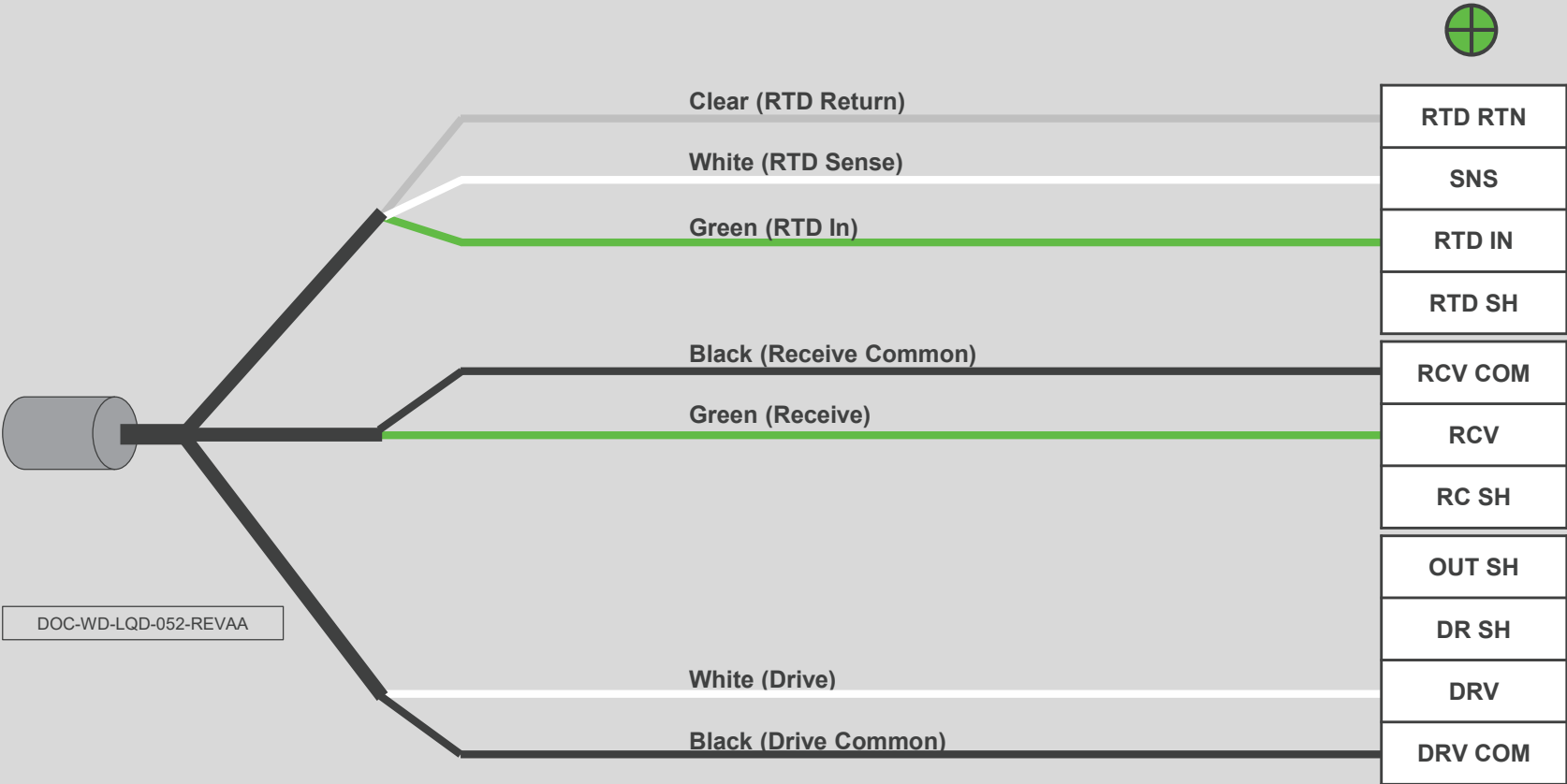

Rosemount 225-54, 226-54, 228-54, or 222 Conductivity Sensor (Unshielded Cable) to Rosemount 1066 Transmitter Wiring

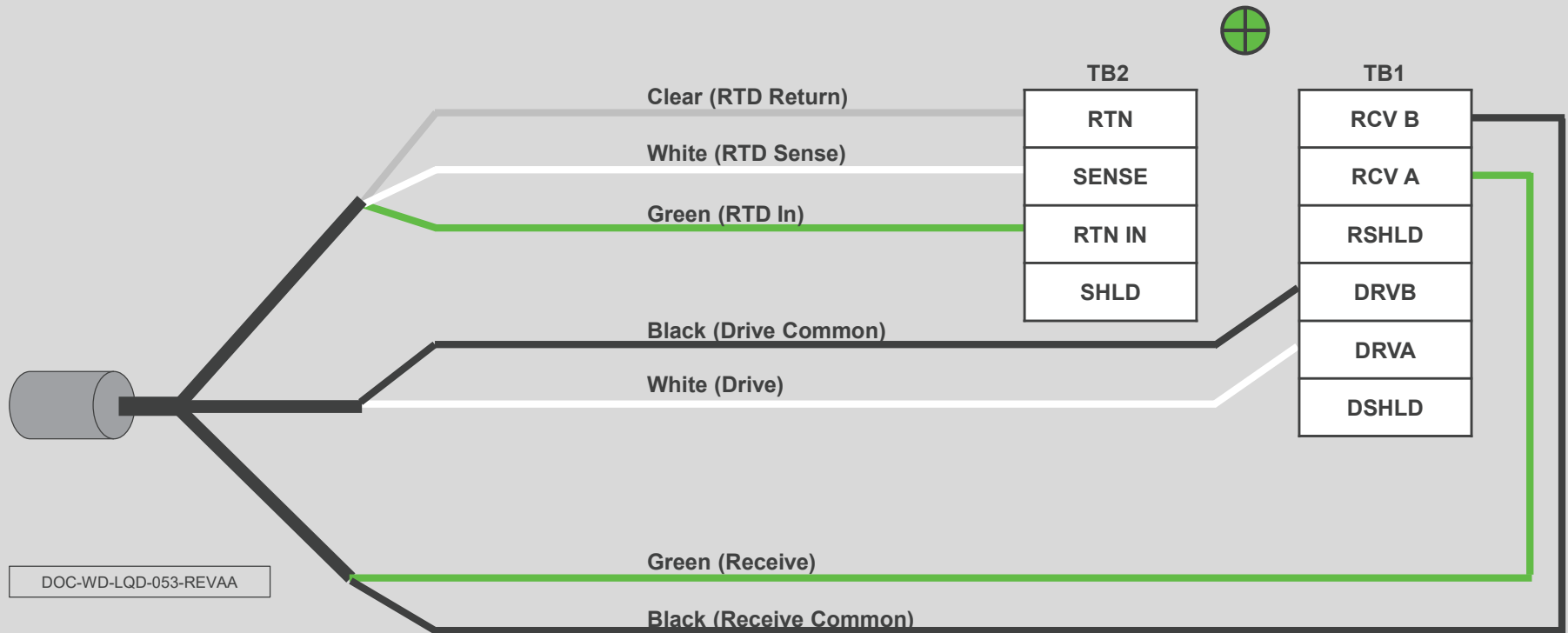

Rosemount 225-54, 226-54, 228-54, or 222 Conductivity Sensor (Unshielded Cable) to Rosemount 56, 1056, 1057, Transmitter Wiring

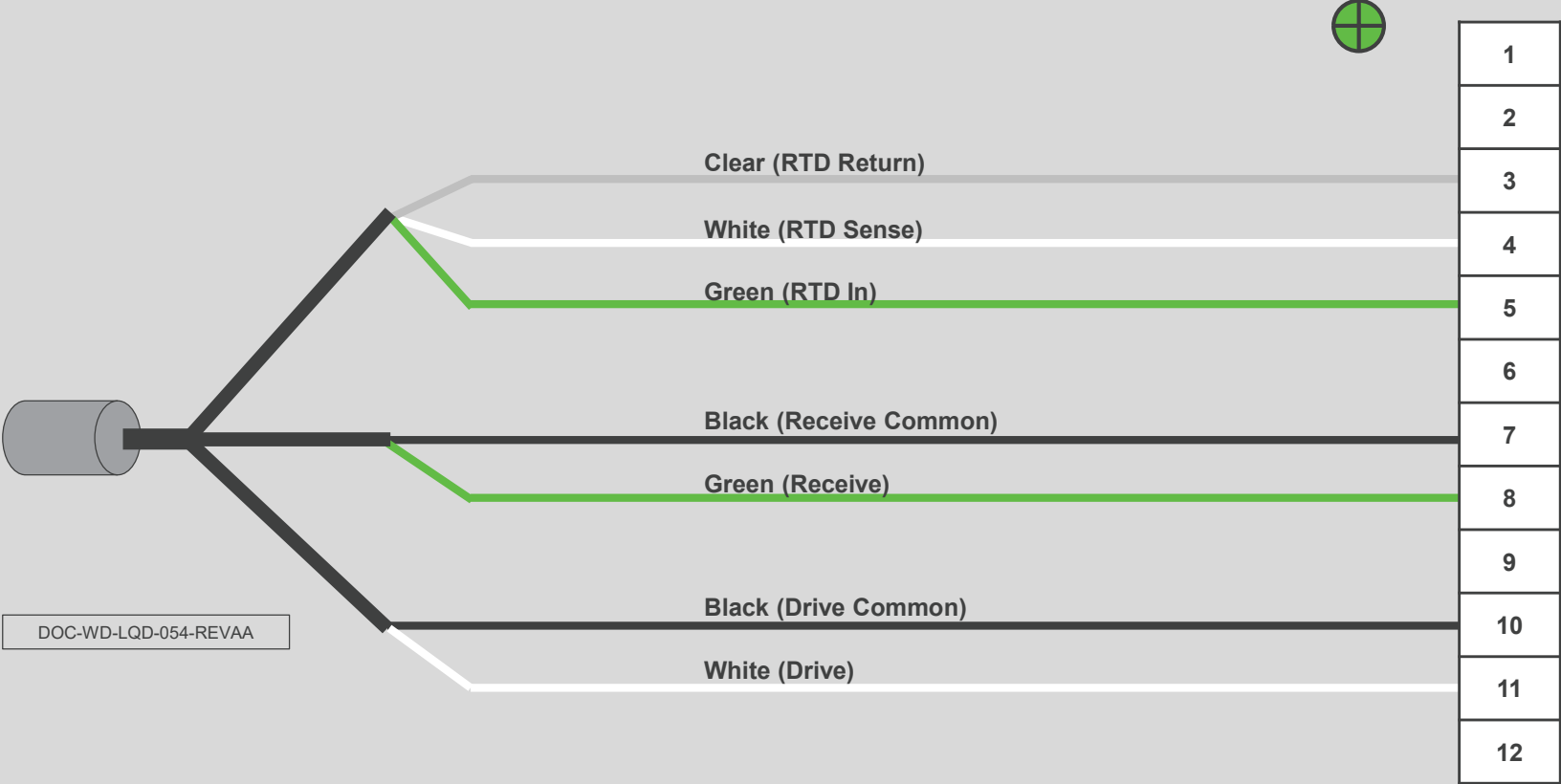

Chlorine, Oxygen, and Ozone Sensors

Rosemount Core Amperometric Chlorine, Ozone, and Dissolved Oxygen Sensors

499ACL
499ADO
499ATrDo
499AOZ

Rosemount 499ACL, 499ADO, 499ATrDO, or 499AOZ Sensors to Rosemount 56, 1056, 1057, or 1058 Transmitter Wiring

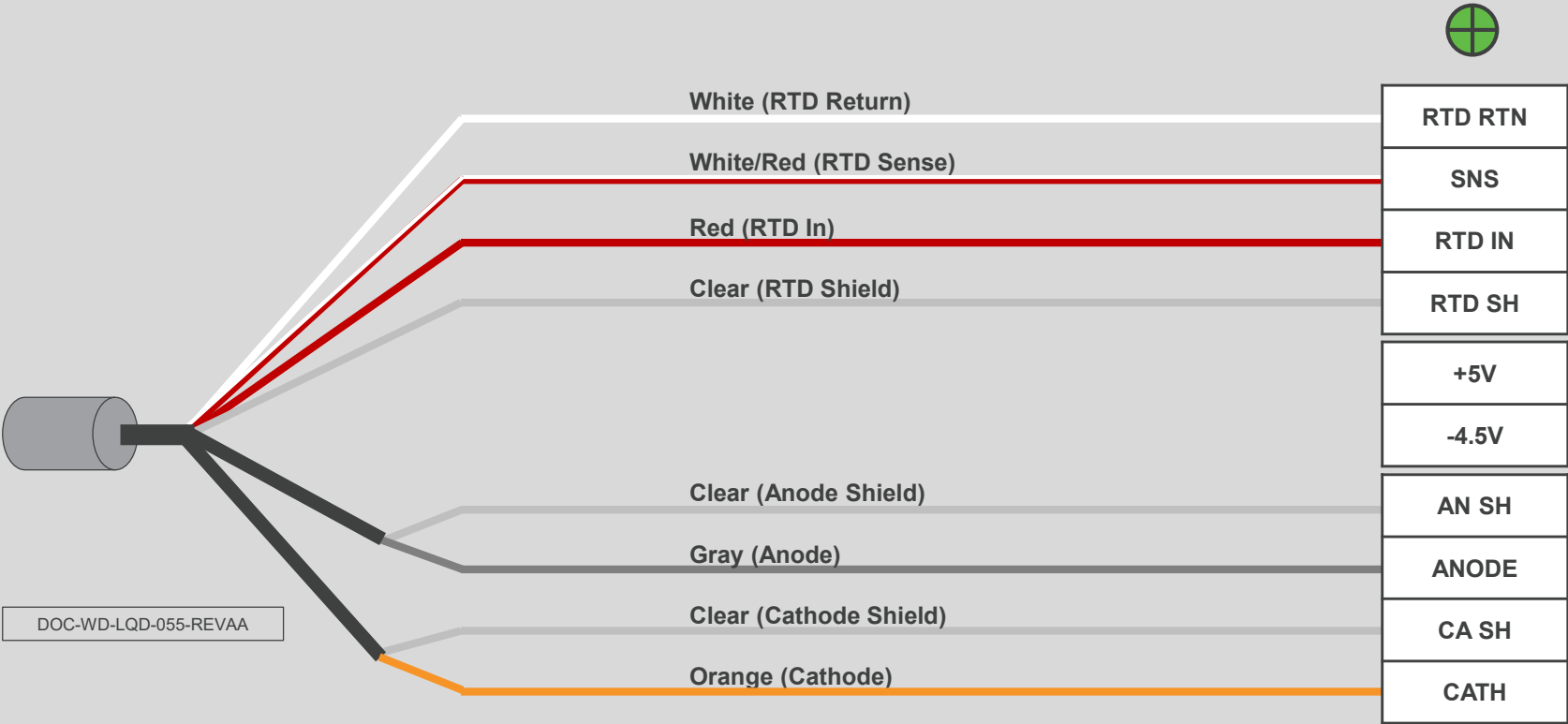

Rosemount 499ACL, 499ADO, 499ATrDO, or 499AOZ Sensor to Rosemount 1066 Transmitter Wiring

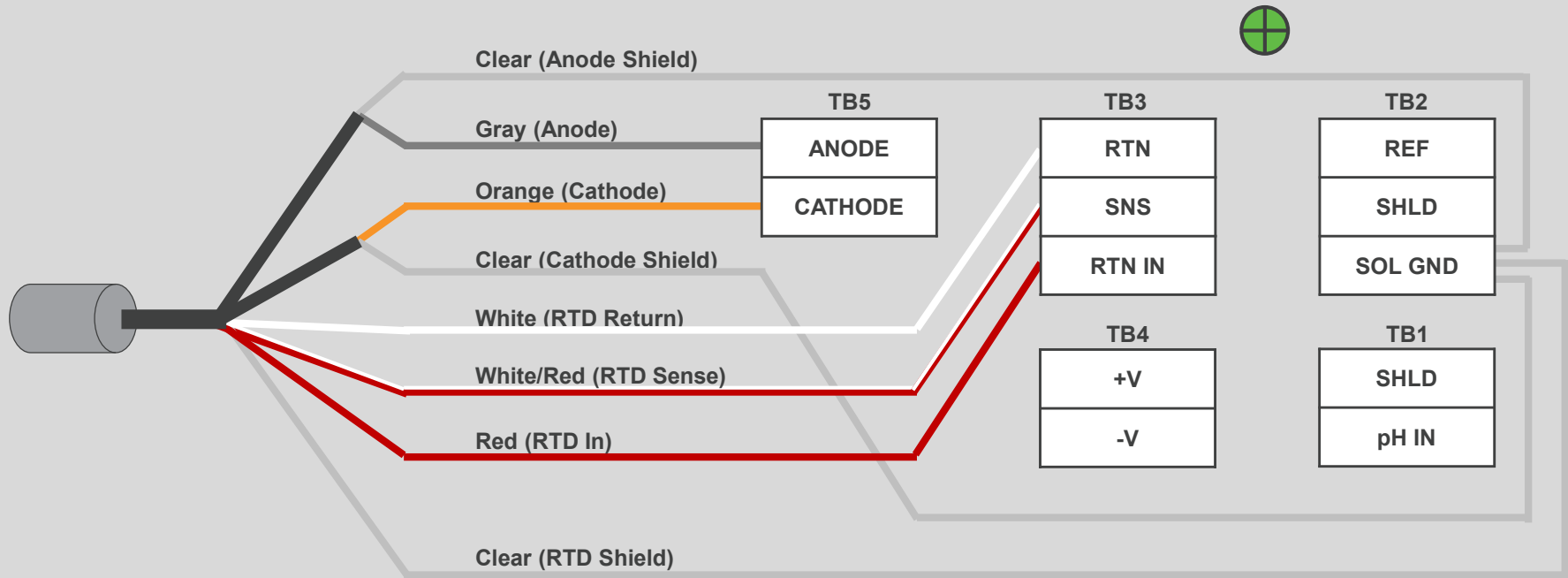

DOC-WD-LQD-056-REVA A

Connect all clear shield wires to solution ground terminal on TB2. Use wire nut and pigtail if necessary

Rosemount 499ACL, 499ADO, 499ATrDO, or 499AOZ Sensor to Rosemount 5081 Transmitter Wiring

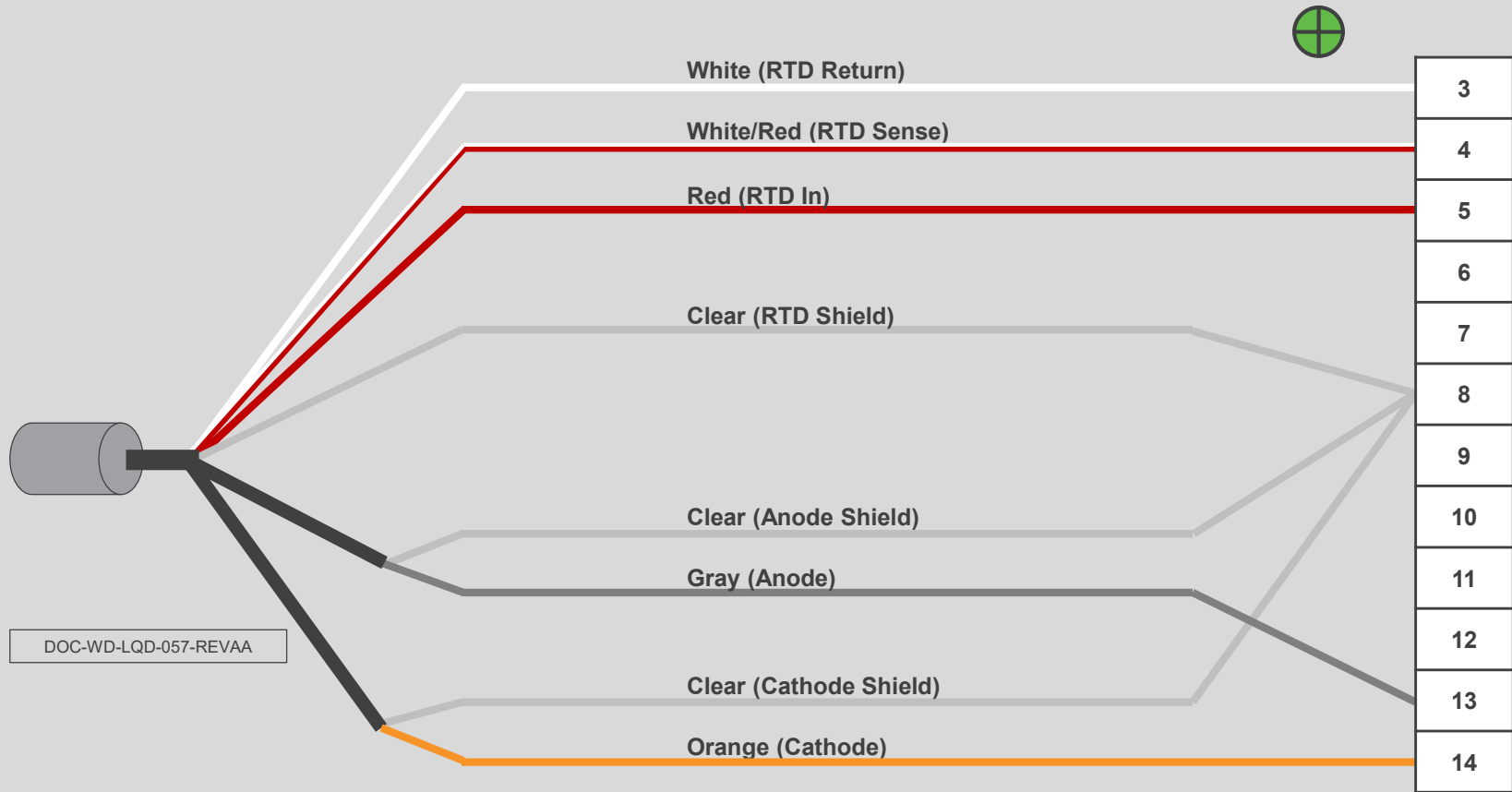

Connect all clear shield wires to terminal 8. Use wire nut and pigtail if necessary

Rosemount Hx438 Amperometric Dissolved Oxygen Sensor

Rosemount Hx438 Sensor to Rosemount 56, 1056, or 1058 Transmitter Wiring

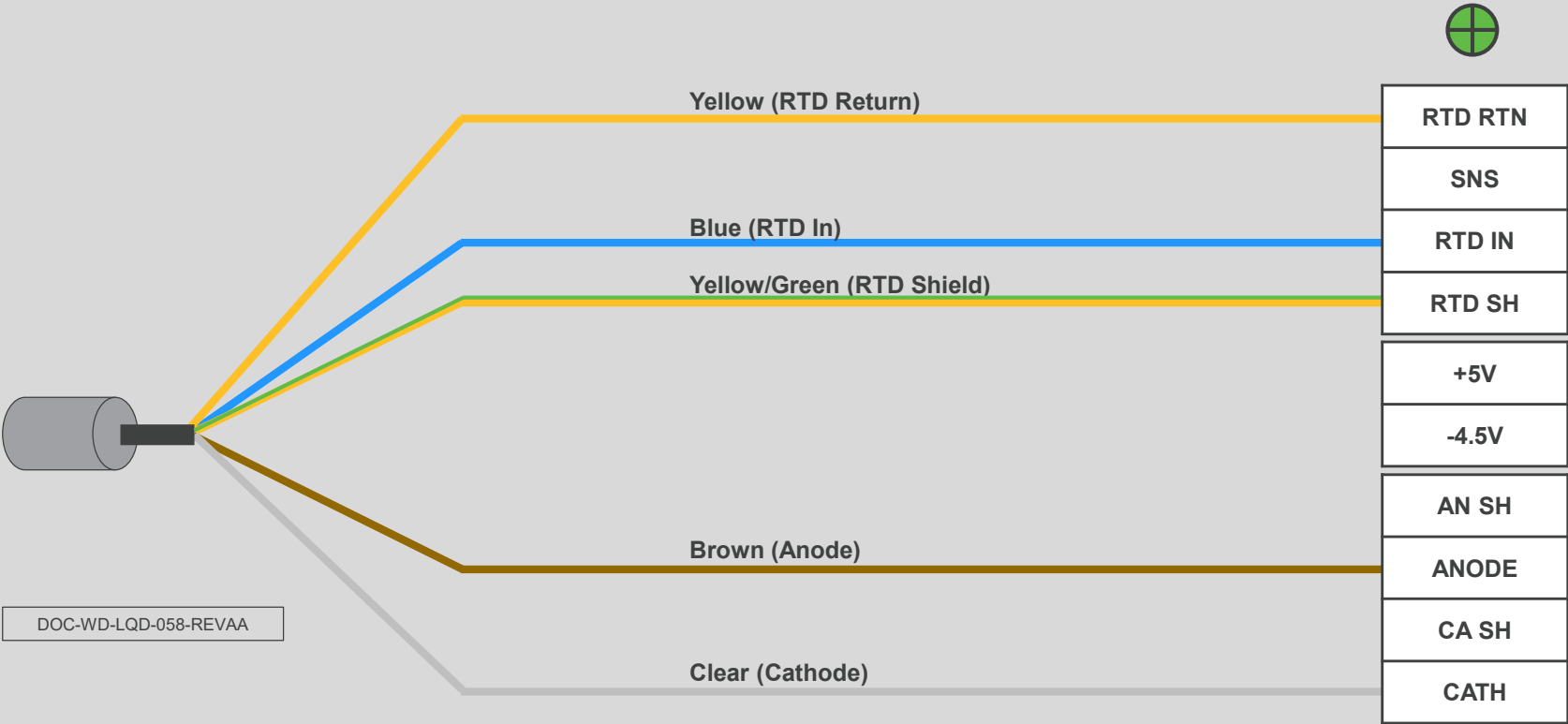

Rosemount Hx438 Sensor to Rosemount 1066 Transmitter Wiring

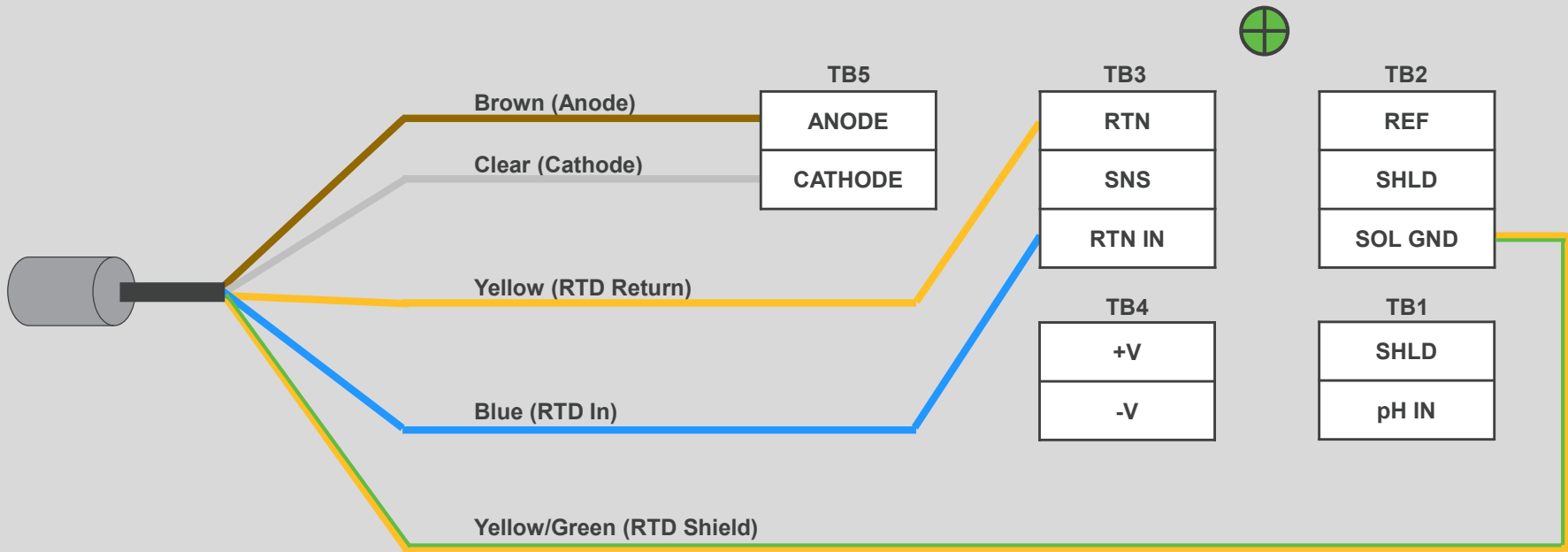

DOC-WD-LQD-059-REVA

Rosemount Hx438 Sensor to Rosemount 5081 Transmitter Wiring

