



Operation Manual

DIGITAL CONTROLLER <MICRO CONTROLLER X>

MODEL : PXG



Read Before Use (Safety Precautions)

Before using this product, read the following safety precautions and use the product correctly. These precautions contain essential information regarding product safety and must be followed at all times.

The safety precautions are divided into "Warning" and "Caution".

⚠ Warning	Misuse of the product may result in serious injury or death.
⚠ Caution	Misuse of the product may result in personal injury or damage to the product.

⚠ Warning

Installation and Wiring

- The controller should be installed under the following conditions:

Ambient temperature	-10 to 50°C
Ambient humidity	90% RH or less (non condensing)
Installation category	II
Degree of pollution	2

According to IEC 1010-1

- Keep the following clearance and creepage distance between the temperature sensor and areas that generate or achieve the following voltages.

Failure to keep these distances goes against the EN 61010 safety standards.

Voltage used or generated [Vrms or Vdc]	Clearance (mm)	Creepage distance (mm)
Max. 50	0.2	1.2
Max. 100	0.2	1.4
Max. 150	0.5	1.6
Max. 300	1.5	3.0
Over 300	Consult your Fuji Electric dealer.	

- If the voltage exceeds 50Vdc (hazardous voltage), basic insulation is required between all of the controller's terminals and the ground, and supplemental insulation is required around the alarm output.

The insulation class of the controller is shown below. Before installation, be sure to verify that the insulation class of the controller meets the requirements.

■ PXG5/9

— Basic insulation - - - No insulation — Functional insulation

Power	Internal circuit
Control output 1 (Relay contact) or Motorized valve OPEN output	Measurement input
	Valve opening feedback input
	Auxiliary analog input (remote SV) Heater current detector input
Control output 2 (Relay contact) or Motorized valve CLOSE output	Control output 1 (SSR drive, current, voltage)
	Control output 2 (SSR drive, current, voltage) or Auxiliary analog output (Re-transmission output) or Transmitter power supply
	Digital input 1 to 5
Digital output 1 (Relay contact)	Digital output 1 to 3 (Relay contact)
Digital output 2 (Relay contact)	
	Digital output 4, 5 (Transistor output)
	Communication (RS-485)

When the ninth digit in the model code is J

(Do1,2 are independent common)

When the ninth digit in the model code is not J

(Do1 to 3 shared common)

■ PXG4

— Basic insulation - - - No insulation — Functional insulation

Power	Internal circuit
Control output 1 (Relay contact) or Motorized valve OPEN output	Measurement input
	Auxiliary analog input (remote SV)
	Heater current detector input
Control output 2 (Relay contact) or Motorized valve CLOSE output	Control output 1 (SSR drive, current, voltage)
	Control output 2 (SSR drive, current, voltage) or Auxiliary analog output (Re-transmission output)
	Digital input 1 to 3
Digital output 1 (Relay contact)	Digital output 1 to 3 (Relay contact)
Digital output 2 (Relay contact)	
	Communication (RS-485)

When the ninth digit in the model code is J

(Do1,2 are independent common)

When the ninth digit in the model code is not J

(Do1 to 3 shared common)

- If there is a danger of a serious accident resulting from failure or defect in the controller, set an appropriate protection circuit on the outside of the unit.
- The controller does not contain a power switch or fuse. Set them when necessary. When setting these items, connect the wiring so that the fuse does not come between the main power switch and the controller. (Main power switch: 2-pole breaker, fuse rating: 250V 1A)

- Use a 600V vinyl insulated cable or equivalent to wire the power supply.
- To prevent controller damage and failure, supply the controller with a correctly rated power voltage.
- To prevent electric shock and controller failure, do not turn on the power until all of the wiring is complete.
- To prevent electric shock or controller fire before turning on the power, verify that the correct distances are kept.
- Do not touch active electrified terminals. Doing so may result in electric shock or malfunction.
- Do not disassemble, fabricate, modify, or repair the controller. Doing so may result in abnormal operations, electric shock, or fire.

Maintenance

- Turn the power off before disconnecting the controller. Failure to do so may result in electric shock, malfunction, or damage to the controller.
- Regular maintenance is recommended to ensure long life-span and safe usage of the controller.
- Some parts on the controller have a limited life-span or may deteriorate with time.
- The controller and accessories come with a one year warranty, providing that the product is used correctly.

⚠ Caution

Cautions for Installation

Avoid installing the controller in the following locations:

- Locations where temperatures may fall below 0°C or exceed 50°C while the controller is in use
- Locations where humidity may fall below 45% RH or exceed 85% RH while the controller is in use.
- Locations where the temperature may suddenly change, causing condensation
- Locations that produce combustible or corrosive gases (esp. sulfide and ammonia gases)
- Locations where the controller is subject to direct vibration or shock
- Locations exposed to water, oil, chemicals, steam, or vapor (If the unit becomes soaked in water, have it inspected by the dealer to prevent short circuits or fire.)
- Locations with a great deal of dust, salt, or iron particles in the air
- Locations where the controller is subject to interference from static electricity, magnetism, or noise
- Locations where the controller is exposed to direct sunlight
- Locations where heat may accumulate due to radiation heat

Cautions when Attaching the Panels

- For model PXG4, insert the unit through the back of the included mounting frame, and push on the frame until the unit is securely fixed in the panel. If there is still slight movement in the unit, gently tighten the two screws until the movement vanishes. (Take care when tightening, as tightening the screws too much may cause the mounting frame to separate from the stopper.)
- The front side of the controller conforms to NEMA-4X (equivalent to IP 66) for waterproofing. To ensure that water does not enter between the controller and the panel, attach the provided packing in the following manner. (Improper attachment will fail to waterproof the area.)
 - (1) As shown in figure 1, insert the panel only after attaching packing to the controller case.
 - (2) As shown in figure 2, fasten with a mounting frame or mounting screws to ensure that there is no gap between the front of the controller and the panel. At this time, check that there are no gaps or warping of the packing as seen in figure 3.
- If the panel strength is weak, it may cause a gap to form between the packing and panel, thus failing to waterproof the area.

Fig. 1
• PXG5/9

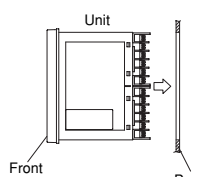

Fig. 2
• PXG5/9

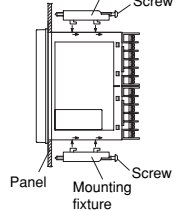
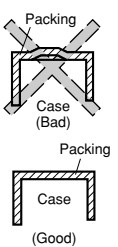
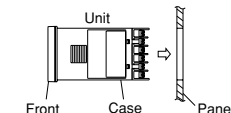

Fig. 3



• PXG4



• PXG4

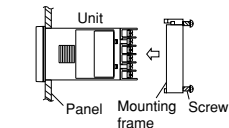

Standard: Attached vertically (Attached horizontally)
When mounting the controller on a tilted surface, the maximum tilt angle is 30 degrees from the vertical.

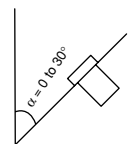

Caution

- Do not block the controller, or the radiation effect will be lessened.
- Do not block the ventilating ducts above the terminals.
- When using PXG9, place the mounting brackets into the mounting hole in the center of the controller.

Cautions for Wiring Connections

- For a thermocouple input use a prescribed compensating lead wire. For a resistance thermometer bulb, use a lead wire with material that has small resistance and no resistance difference among three wires.
- Keep input signal lines apart from the power and load lines to avoid the influence of noise.
- Keep the input and output signal lines separated and shielded.
- If there is excessive noise from the power supply, Fuji Electric recommends adding an insulating transformer and adding a noise filter.
(Example: ZMB22R5-11 Noise Filter manufactured by TDK)
Make sure that the noise filter is installed onto a part, such as a panel, that is grounded. Keep the wire connecting the noise filter output to the instrument power terminal as short as possible. Do not install items such as a fuse or power switch onto the noise filter output wiring. Doing so will reduce the effect of the filter.
- Connecting the instrument power wire with a braided power cord is especially useful to reduce noise. (The shorter the braiding pitch is, the more effective it will be against noise.)
- For controller with an alarm against heater wire breaks, do not connect the heater power and the instrument power to the same power line.
- The contact output requires warm-up time when the power is turned on. Use a delay relay if the contact output signal is used for circuits such as the external interlock circuit. Use a supplemental relay, as the life of the output relay is shortened if it is connected to a full capacity load. Fuji Electric suggests an SSR/SSC drive output type if the output operations occur frequently.
[Proportional Interval] relay output: 30 seconds or more,
SSR/SSC: 1 second or more
- If inductive loads such as magnetic switches are connected as a relay output load, Fuji Electric suggest using our Z-Trap to protect the contacts from switching surges and ensure a longer product life.

Model : ENC241D-05A (For 100V voltage)
ENC471D-05A (For 200V voltage)

Mounting position : Connect it to the relay control output contact

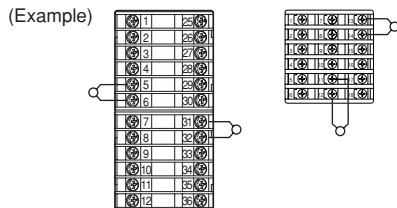

Cautions for Key Operations/Error Operations

- If the alarm function is not connected correctly, it will not sound during controller error. Be sure to check that it is operating correctly before running the controller.
- When there is a break in input, "UUUU" or "LLLL" will display on the screen. Be sure to turn the power off when changing the sensors.

Other

- Do not wipe the controller with organic solvents such as alcohol or benzene. Use only a mild detergent to wipe the machine.

Contents

1. Part Names and Functions

Part Names and Functions	10
Keypad	10
Display	10

2. Overview of Basic Operations and Parameters

Basic Operation	12
Operation Mode	13
Manual Mode	13
Monitor Mode	13
Setup Mode	13
Parameter Overview	14
Steps for Setting Parameters	19
Prepare	19
Operation	19

3. Operation Parameters (Ch1)

Overview of Operation Parameters (Ch1)	22
Auto/Manual Switch	23
1. Changing Modes from the Front Panel	23
2. Changing Modes from the Channel Menu	23
Standby Switch	24
Switching Standby Mode	24
Switching Between Local and Remote Operation	24
Switching Between Local and Remote Operation	24
Ramp/Soak Command	25
Activating the Ramp/Soak Command	25
Auto-tuning	25
Running Auto-tuning	25
DO Output Latch Cancel	26
Canceling the DO Output Latch	26
SV No. Switch	26
Changing SV Number	26
Changing PID No.	27
Changing the PID No.	27
Alarm Settings	27
Setting Key Lock	27
Key Lock	28
Setting Key Lock	28

4. Control (PID) Parameters (Ch2)

Overview of Control (PID) Parameters (Ch2)	30
Proportional Band, Integration Time, Derivative Time	31
Setting PID	31
ON/OFF Control Hysteresis	32
Setting ON/OFF Control Hysteresis	32
Cooling Proportion Band Coefficient	33
Setting Cooling Proportional Band	33
Dead Band	34
Setting Dead Band	34
Output Convergence Value	35

Setting the Output Convergence Value	35
Anti-reset Windup	36
Setting the Anti-reset Windup	36
Normal/Reverse Setting	37
Setting the Normal/Reverse Setting	37
SV Lower Limits, SV Upper Limits	38
Setting the SV Upper and Lower Limits	38
OUT1 Proportional Cycles, OUT2 Proportional Cycles	39
Setting the Preset OUT1/OUT2 Values	39
OUT1 Upper/Lower Limits, OUT2 Upper/Lower Limits	40
Setting OUT1/OUT2 Upper/Lower Limits	40
Setting Output Limiter Types	41
Setting Output Limiters	41

5. PID Palette Parameter (Ch3)

Overview of PID Palette Parameters (Ch3)	44
SV Set Value	46
Setting SV	46
Proportional Band, Integration Time, Derivative Time	47
Setting PID	47
ON/OFF Control Hysteresis	48
Setting ON/OFF Control Hysteresis	48
Cooling Proportional Band	48
Setting Cooling Proportional Band	48
Dead Band	49
Setting Dead Band	49
Output Convergence Value	49
Setting the Output Convergence Value	49
Anti-reset Windup	50
Setting the Anti-reset Windup	50
Normal/Reverse Setting	50
Setting the Normal/Reverse Setting	50
Setting the Maximum SV Selection Number	51
Setting the SV No. Max	51
Setting the Maximum PID Selection Number	51
Setting the PID No. Max	51

6. Ramp/Soak Parameters (Ch4)

Overview of Ramp/Soak Parameters (Ch4)	54
Ramp/Soak Activation Pattern (Step No.)	56
Setting the Ramp/Soak Activation Pattern	56
Ramp/Soak Time Units	57
Setting Ramp/Soak SV, Ramp Time and Soak Time	57
Ramp/Soak SV Select (step1) to (step16), Ramp Time (step1) to (step16), Time Soak (step1) to (step16)	58
Setting Ramp/Soak SV, Ramp Time and Soak Time	58
Ramp/Soak Mode	59
Setting the Ramp/Soak Mode	59
Guaranteed Soak, Guaranteed Soak Lower Limit, Guaranteed Soak Upper Limit	60
Setting Guaranty Soak	60

PV start.....	61
Setting PV Start	61
Continue mode	61
Setting the Continue Mode.....	61
Setting the Max Pattern Selection,	
Setting the Min Pattern Selection	62
Selecting a Maximum/Minimum Number of Patterns	62

7. Monitor Parameters (Ch5)

Overview of Monitor Parameters (Ch5)	64
Ramp/Soak Operation Display	65
Checking the State of Ramp/Soak	65
Control Output Display	65
Checking the Control Output Display	65
PFB Input Value Display	66
Checking the PFB Input Value Display	66
Remote SV (RSV) Input Display.....	66
Checking the Remote SV Input Value	66
Heater Current Display	67
Checking the value for Heater current.....	67
Leak current Display	67
Checking the value for Leak current.....	67
Remaining Time on Timer	68
Checking the Time Remaining on Timer	68
Error Source Display	68
Checking the Error Source	68
Current palette No.	69
Checking the Palette No.....	69
Current pattern No.....	69
Checking the Pattern No.	69

8. Setup Parameters (Ch6)

Overview of Setup Parameters (Ch6).....	72
PV Input Types.....	74
Setting the PV Input Type.....	74
PV Input Lower Limit, PV Input Upper Limit	75
Setting PV Input Upper/Lower Limits	75
Decimal Place	75
Setting the Decimal Place	75
PV Input Shift	76
Setting PV Input Shift.....	76
SV Offset	76
Setting SV Shift.....	76
PV Input Filter.....	77
Setting the PV Input Filter	77
PV Display Zero Adjustment,	
PV Display Span Adjustment.....	78
Setting PV Display Zero/Span.....	78
Cold Junction Compensation.....	79
Setting Cold Junction Compensation	79
Remote SV Zero Adjustment,	
Remote SV Span Adjustment.....	80

Adjusting Remote SV Zero/Span.....	80
Remote SV Input Range	81
Setting the Remote SV Input Range	81
Remote SV Input Filter.....	82
Setting the Remote SV Filter	82
OUT1 Range, OUT2 Range.....	83
Setting the OUT1/OUT2 Range.....	83
FALT OUT1 Value, FALT OUT2 Value	83
Setting FALT OUT1/OUT2	83
Soft Start OUT1 Output, Soft Start Time	84
Setting Soft Start OUT1 Output/OUT1 Time	84
Standby OUT1 Output, Standby OUT2 Output.....	85
Setting Standby Mode OUT1/OUT2 Output	85
Standby Mode Settings.....	85
Setting Standby Mode Output	85
AO Output Type.....	86
Setting AO Output Type	86
AO Lower Limit Scaling, AO Upper Limit Scaling	87
Setting AO Upper/Lower Limit Scaling	87

9. System Parameters (Ch7)

Overview of System Parameters (Ch7).....	90
USER Key Assignments	93
Setting USER Key Assignments.....	93
DI Function Select.....	94
Selecting DI Function	94
DO Event Type	96
Setting DO Option Functions.....	97
DO Option Functions	98
Setting DO Option Functions.....	98
Ramp SV ON/OFF, Ramp SV decline, Ramp SV incline,	
Ramp SV slope time unit	99
Setting Ramp SV	99
SV Display Mode	100
Setting the SV Display Mode.....	100
Control Method	101
ON/OFF (2 setting) control	101
Reverse Operation (Heating)	101
Normal Operation (Cooling)	101
PID Control	102
Setting PID Control	102
Fuzzy PID Control	102
Changing to Fuzzy PID Control.....	102
Self-tuning Control.....	103
Conditions where self-tuning can be used	103
Conditions where self-tuning cannot be used	103
Conditions to halt self-tuning	103
Setting Self-Tuning	104
About Self-Tuning Methods	104
PID2 Control	106
Changing to PID2 Control	106
Auto-tuning	107

Control Target	108
Servo Control 1/Servo Control 2	108
Changing to Servo Control 1 or Servo Control 2	108
Setting the Valve Stroke Time	109
Position Feedback Control (PFB Control)	109
Changing to Position Feedback Control	109
HYS mode setting	110
Startup Mode Settings	110
Setting the Startup Mode	110

10. Alarm Parameters (Ch8)

Overview of Alarm Parameters (Ch8)	112
Alarm Hysteresis, Delay Time, Delay Time Units	113
Adjusting the Settings	113
HB Alarm Set Value, HB Alarm Hysteresis	114
Setting Heater Break Alarm Points	115
Load short-circuit alarm setting	
Load short-circuit alarm hysteresis	116
Setting the Load Short-circuit Alarm Timing	116
Loop Break Detection Time,	
Loop Break Detection Width	117
Setting Loop Break Time and Width	117

11. Communication Parameters (Ch9)

Overview of Communication Parameters (Ch9)	120
ST No. Setting	122
Setting the Station Number	122
Parity Setting	122
Setting Communications Speed and Parity Check	122
Communication Permission	123
Setting Communication Permission	123

12. Position Feedback Parameters (PFB, Ch10)

Overview of Position Feedback Parameters (PFB, Ch10)	126
PFB Dead Band	127
Setting Valve Stroke Time	127
Valve Stroke Time	127
Setting the Valve Stroke Time	127
PFB Input Adjustment Command	128
Making Adjustments Manually	128
Making Adjustments Automatically	129

13. Password Setup (Ch11)

Overview of Password Setup (Ch11)	132
Passwords 1 to 3	132
Steps for Setting the Password	132

14. Display Mask for Each Parameter (Ch12)

Overview of Display Mask (Ch12)	134
Display Parameters 1 to 30	139
Steps for Setting Displayed Parameters	139

15. Environmental Parameters (Config Ch13)

Overview of Environmental Parameters (Ch13)	142
Display Timeout Settings	143
Setting the Display Timeout	143
Remote Blink Setting	144
Setting the Remote SV Blink Setting	144
Soft Start Blink Setting	144
Setting the Soft Start Blink Setting	144
ALM Blink	145
Setting ALM Blink	145
Burnout Control Selection	146
Setting procedure of burnout control selection	146
Ramp soak pattern order	147
Changing the Ramp Soak Pattern Order	147
C2 Lamp Allocation	148
Setting the C2 Lamp Allocation	148
Controller Reset	149
Resetting the Main Unit	149

16. Troubleshooting

Troubleshooting	152
-----------------------	-----

17. Appendix

Delay Start Function	154
Setting the Delay Start Function	154
Return to Factory Default Setting Function	155
Setting the Return to Factory Default Setting Function	155

PXG4 Model Specifications

■ PXG4 Standard Model List

Digit	Specifications	1	2	3	4	5	6	7	8	9	10	11	12	13	14	Notes
4	<Size of front WxH> 48 x 48 mm	P	X	G	4											
5	<Output 1> Relay contacts SSR drive Current (0 to 20mA DC / 4 to 20mA DC) Voltage (0 to 5V DC / 1 to 5V DC / 0 to 10V DC / 2 to 10V DC)					A C E P										Note 1 Note 1
6	<Output 2> None Relay contacts SSR drive Current (0 to 20mA DC / 4 to 20mA DC) Voltage (0 to 5V DC / 1 to 5V DC / 0 to 10V DC) Re-transmission output current (0 to 20mA DC / 4 to 20mA DC) Re-transmission output voltage (0 to 5V DC / 1 to 5V DC / 0 to 10V DC / 2 to 10V DC)					Y A C E P R S										Note 2,4 Note 2,4 Note 2,4 Note 2,4 Note 2,4
7	<Option 1> None RS485 Digital input (No. 1) + digital input (No. 2) Digital input (No. 1) + RSV1 Digital input (No. 1) + CT1 RS 485 + digital input (No. 1) RS 485 + RSV1 RS 485 + CT1 RS 485 + Digital input (No. 1) + RSV1 Digital input (No. 1) + RSV1 + Digital input (No. 2)					Y M T H G V K J F 2										Note 1,3 Note 1,3 Note 4 Note 4
8	<Revision symbols>								1							
9	<Digital Output> (Relay contact output) None Digital output 1 point (No.1) Digital output 2 points (No.1, 2) Digital output 3 points (No.1, 2, 3) Digital output 2 points [independent common] (No.1, 2)									0 1 F M J						Note3 Note2
10	<Power supply> < Instruction manual> 100V/240V AC no instruction manual 100V/240V AC English instruction manual 24V AC/DC no instruction manual 24V AC/DC English instruction manual										N V C B					
11	<Option 2> None											Y				
12													0			
13														0		

Note 1: If output 1 was for current or voltage output, option cannot be assigned to CT1.
(If 7th digit was assigned to G or J, 5th digit cannot be assigned to E nor P.)

Note 2: If output 2 was for relay contact, SSR drive, current, voltage or retransmission output, 3 digital outputs cannot be assigned.

(If 6th digit was assigned to A, C, E, P, R or S, 9th digit cannot be assigned to M.)

Note 3: If CT1 was selected in option 1, none in <Digital output> cannot be assigned.

(If 7th digit was assigned to G or J, 9th digit cannot be assigned to 0.)

Note 4: If RSV1 in option 1 and digital input 1 were selected simultaneously, output 2 cannot be assigned.

(If 7th digit was assigned to F or 2, 6th digit cannot be assigned to A, C, E, P, R nor S.)

■ PXG4 Motorized Valve Control Model List

Digit	Specifications	1	2	3	4	5	6	7	8	9	10	11	12	13	14	Notes
4	<Outer dimensions WxH> 48 x 48 mm	P	X	G	4											
5	<Output 1> Electromagnetic valve control output					S										Note 1
6	<Output 2> None						Y									
7	<Option 1> None Digital input (No. 1) + RSV1 Digital input (No. 1, 2, 3) RS 485 + digital input (No. 1) RS 485 + RSV1						Y H D V K									
8	<Revision symbols>								1							
9	<Digital Output> (Relay contact output) None Digital output 1 point (No.1) Digital output 2 points (No.1, 2) Digital output 2 points [independent common] (No.1, 2)									0 1 F J						
10	<Power supply> < Instruction manual> 100V/240V AC no instruction manual 100V/240V AC English instruction manual 24V AC/DC no instruction manual 24V AC/DC English instruction manual										N V C B					
11	<Option 2> None											Y				
12													0			
13														0		

Note 1: If front panel size 48 x 48, position feedback input (PFB input) function is not available.

PXG5/9 Model Specifications

■ PXG5/9 Standard Model List

Digit	Specifications	1	2	3	4	5	6	7	8	9	10	11	12	13	14	Notes
4	<Size of front WxH> 48 x 96 mm 96 x 96 mm	P	X	G	5											Note 1
5	<Output 1> Relay contacts SSR drive Current (0 to 20mA DC / 4 to 20mA DC) Voltage (0 to 5V DC / 1 to 5V DC / 0 to 10V DC / 2 to 10V DC)					A C E P										Note 2 Note 2
6	<Output 2> None Relay contacts SSR drive Current (0 to 20mA DC / 4 to 20mA DC) Voltage (0 to 5V DC / 1 to 5V DC / 0 to 10V DC / 2 to 10V DC) Re-transmission output current (0 to 20mA DC / 4 to 20mA DC) Re-transmission output voltage (0 to 5V DC / 1 to 5V DC / 0 to 10V DC / 2 to 10V DC) Transmitter power supply						Y A C E P R S T									Note 4 Note 4 Note 4 Note 4 Note 4 Note 4 Note 1,4
7	<Option 1> None RS 485 Digital input (No. 1) + digital input (No. 2) Digital input (No. 1) + RSV1 Digital input (No. 1) + CT1 RS 485 + digital input (No. 1) RS 485 + RSV1 RS 485 + CT1 RS 485 + digital input (No. 1)+RSV1 Digital input (No. 1) + RSV1+Digital input (No. 2)						Y M T H G V K J F 2									Note 3 Note 2,5,6 Note 3 Note 2,5,6 Note 4 Note 4
8	<Revision symbols>								1							
9	<Digital Output> (Relay contact output) None Digital output 1 point (No.1) Digital output 2 points (No.1, 2) Digital output 3 points (No.1, 2, 3) Digital output 2 points [independent common] (No.1, 2)									0 F M J						Note 5
10	<Power Supply> <Instruction Manual> 100V/240V AC no instruction manual 100V/240V AC English instruction manual 24V AC/DC no instruction manual 24V AC/DC English instruction manual										N V C B					
11	<Option 2> None Digital input (No. 3, 4, 5) + CT2 Digital input (No. 3, 4, 5) Digital input (No. 3, 4, 5) + digital outputs (No. 4, 5) [transistor output] Digital input (No. 3, 4, 5) + RSV2										Y A B C D					Note 2,5,6 Note 3
12													0			

Digit	Specifications	1	2	3	4	5	6	7	8	9	10	11	12	13	14	Notes
13														0		

- Note 1: For outer dimensions of 48 x 96, the transmitter power supply output cannot be specified.
(5 in the fourth digit and T in the sixth digit cannot be specified.)
- Note 2: If output 1 was for current or voltage output, option cannot be assigned to CT1 nor CT2.
(If 7th digit was assigned to G or J, or 11th digit to A, 5th digit cannot be assigned to E nor P.)
- Note 3: RSV1 in option 1 and RSV2 in option 2 cannot be assigned simultaneously.
(If 7th digit was assigned to H or K, 11th digit cannot be assigned to D.)
- Note 4: In case, in option 1, of DI 2 points + RSV1 or RS485 + DI 1 + RSV1, output 2 cannot be assigned.
(If 7th digit was assigned to F or 2, 6th digit cannot be assigned to A, C, E, P, R nor S.)
- Note 5: In case of CT1 in option 1, or CT2 in option 2, digit output cannot be assigned to None.
(If 7th digit was assigned to G or J, or 11th digit to A, 9th digit cannot be assigned to 0.)
- Note 6: CT1 in option 1 and CT2 in option 2 cannot be assigned simultaneously.
(If 7th digit was assigned to G or J, 11th digit cannot be assigned to A.)

■ PXG5/9 Motorized Valve Control Model List

Digit	Specifications	1	2	3	4	5	6	7	8	9	10	11	12	13	14	Notes
4	<Size of front WxH> 48 x 96 mm 96 x 96 mm	P	X	G	5											Note 1
5	<Output 1> Motor valve control output (no PFB input) Motor valve control output (PFB input)					S V										
6	<Output 2> None Auxial DO output Transmitter power supply						Y A T									Note 1
7	<Option 1> None Digital input (No. 1, 2, 3) + RSV1 RS 485 + digital input (No. 1, 2, 3) RS 485 + digital input (No. 1) + RSV1						Y E U F									
8	<Revision symbols>								1							
9	<Digital Output> (Relay contact output) None Digital output 1 point (No.1) Digital output 2 points (No.1, 2) Digital output 3 points (No.1, 2, 3) Digital output 2 points [independent common] (No.1, 2)									0 1 F M J						
10	<Power Supply> <Instruction Manual> 100V/240V AC no instruction manual 100V/240V AC English instruction manual 24V AC/DC no instruction manual 24V AC/DC English instruction manual										N V C B					
11	<Option 2> None											Y				
12													0			
13														0		

Note 1: If front panel size 48 x 96, the transmitter power supply output is not available.

Chapter 1

Part Names and Functions

Part Names and Functions – 10

Part Names and Functions

This section details the name and function of each part of the face panel.

Chapter
1

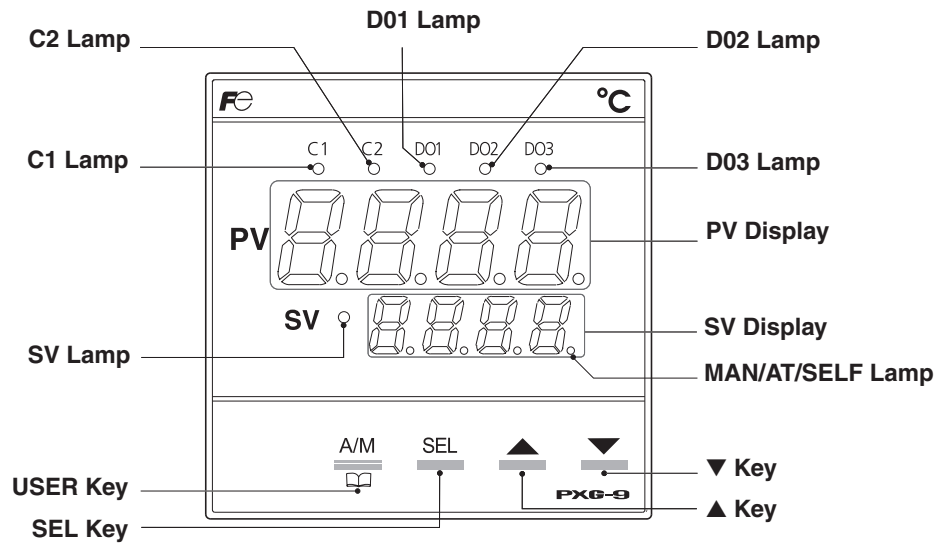

Keypad

USER Key

Pressing this key in monitor mode display or setup mode display returns you to the PV/SV display.

Pressing this key on the PV/SV display allows you to set the function for "UKEY" under the system menu ("SYS Ch 7"). (Auto/Manual switching is set to this key by factory default.)

SEL Key

Pressing this key switches you to monitor mode display or setup mode display from PV/SV display.

After switching to parameter mode, this key functions as the select key when changing parameters.

Holding this key down in channel display or parameter display returns you to the PV/SV display.

Pressing this key in PV/SV display shows the manual output value at the bottom of the screen.

▲ Key

Pressing once will increase the setting value by one. Holding down the button will continue to increase the value.

It changes SV on the PV/SV display.

It is also used to move between items in channel screen display and parameter screen display.

▼ Key

Pressing once will decrease the setting value by one. Holding down the button will continue to decrease the value.

It changes SV on the PV/SV display.

It is also used to move between items in channel screen display and parameter screen display.

Display

C1/C2 Lamp

Displays the condition of the control output. Lights on at 100% output and goes off at 0% output. For values between 0% and 100%, the output is indicated by the length of time the lamp flickers. When acting as a valve control, the C1 lamp will flicker with OPEN output, and the C2 lamp will flicker with CLOSE output.

DO1/2/3 Lamp

Lights on when there is digital output (Do) from Do 1, Do 2, or Do 3. The lamp blinks when delay action is on.

PV Display

Displays setting values (PV). Displays the name of the parameter when setting parameters.

SV Display

Displays set values (SV). Also can display the output value during manual mode. Displays current value when changing parameter settings. Displays "rEn" during remote mode, and "Soft" during soft start.

SV Lamp

Illuminates when displaying the SV value. Does not illuminate in manual mode.

The lamp blinks while performing ramp/soak or lamp SV operations.

MAN/AT/SELF Lamp

The lamp stays lit during manual mode. The lamp blinks during auto-tuning and self-tuning.

Chapter 2

Overview of Basic Operations and Parameters

Basic Operation – 12



Parameter Overview – 14



Steps for Setting Parameters – 19

Basic Operation

This device has four modes: operation mode, manual mode, monitor mode, and setup mode. This section outlines each mode and explains its key functions.

Refer to the following diagram for information about key functions and changing modes.

"Press and hold" means to press a key and hold it for about one second.

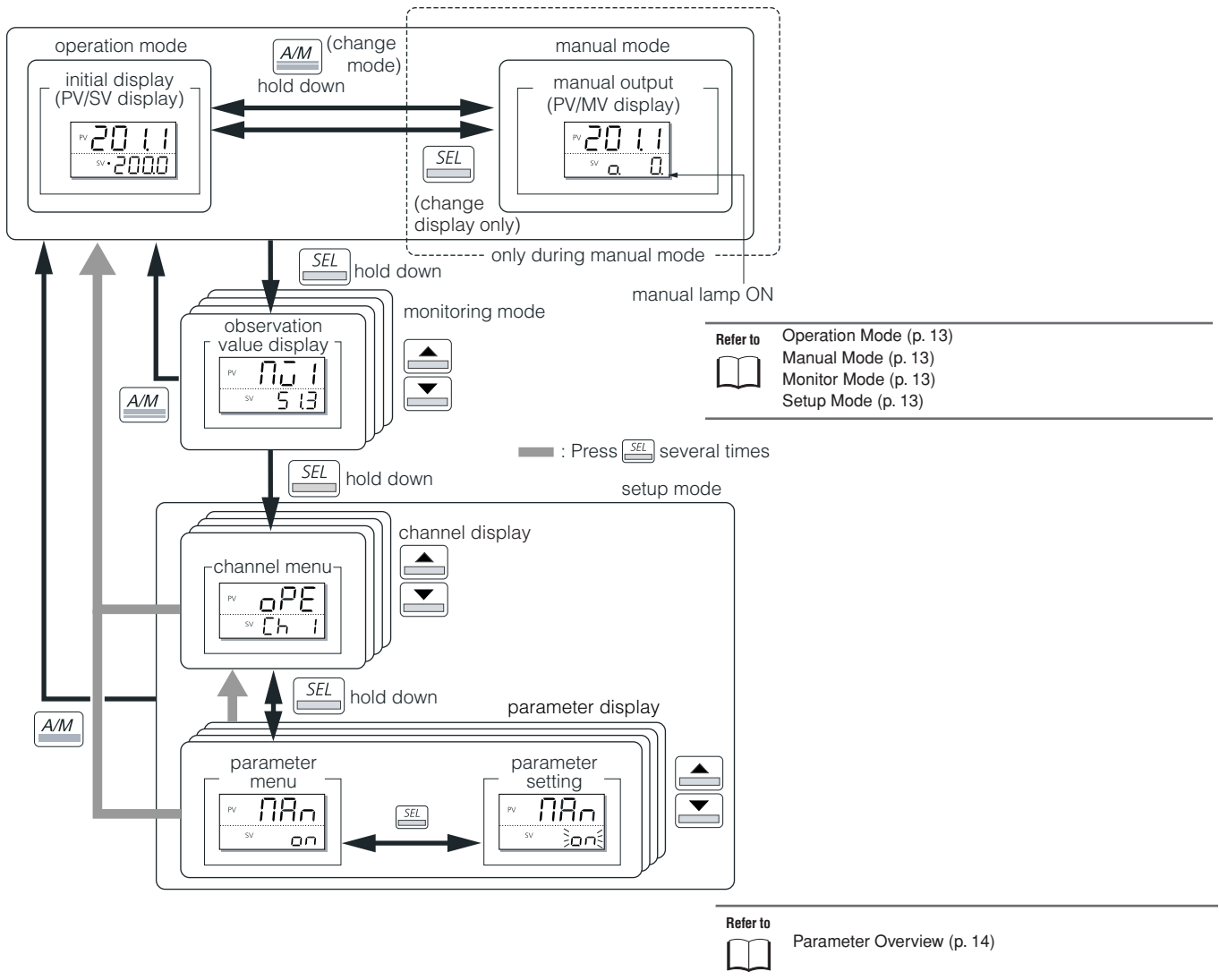

Pressing the **A/M** key or the **SEL** key switches between modes. Pressing **▲▼** in monitor mode or setup mode allows you to choose menu items.

● Changing SV (set values)

- 1** Change the display to PV/SV display (shown when you turn on the power and the SV lamp is lit).
- 2** Change the SV value with the **▲▼** keys.
- 3** Press the **SEL** key to save the values. (The value will be automatically saved after 3 seconds even if a key is not pressed.)



● Changing MV (control output values)

- 1** Switch to manual mode.
- 2** Change the display to PV/MV display (MAN/AT/SELF lamp is lit). (Pressing the **SEL** key in manual mode toggles between PV/SV display and PV/MV display.)
- 3** **▲▼** Change the MV value with the **▲▼** keys. (Changes are reflected to the MV value as it is changed.)

Operation Mode

Operation mode is the regular mode of operation. PV and SV values are displayed. Control output and alarm output are suspended during standby, but the PV value is displayed as normal and the SV value blinks. The controller starts in this mode when the power is turned on.



Manual Mode

Manual mode allows you to set MV output manually. The PV value is displayed, as in operation mode. Use the  key and  key to change the MV value, displayed as a percentage from -3% to 103%.

Manual display mode only appears when the controller is set to manual mode.

Monitor Mode





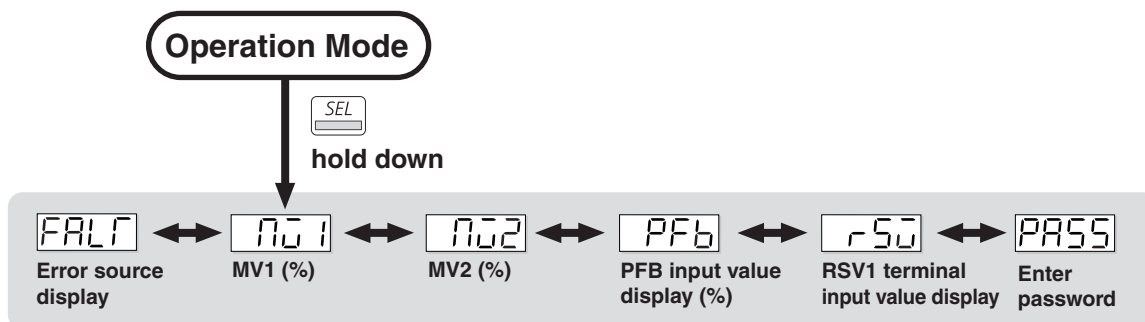

Monitor mode allows you to confirm the status of the controller by checking each value.





To enter monitor mode from operation mode or manual display mode, press and hold the  key. The device will enter monitor mode with [MV1] selected. Use the  key and  key to scroll through the information.

● Monitor Mode



Setup Mode

Setup mode allows you to set the parameters for the device. To enter setup mode, first press and hold the  key when in operation mode or manual display mode to enter monitor mode with [MV1] selected. Then press and hold the  key to enter the channel menu in setup mode. Use the  key and  key to select the channel that includes the parameter you wish to change. Press and hold the  key, then use the  key and  key to check the parameters and their values.

To change the value of a parameter, press the  key when the value of the parameter you wish to change is being displayed. The parameter value will blink and can be changed with the  key and  key. Press the  key again to set the parameter to your desired value. The value will then cease blinking.

Parameter Overview

The parameters are divided into 13 channels. Each channel contains one series of parameters. Refer to the following chapter for a detailed explanation of each channel. The following is an overview of the channels.

Channel	Display	Parameter Name	Overview	Page
Ch 1	oPE	Operation	Sets the parameters for operation.	21
Ch 2	PId	Control (PID)	Sets the parameters concerning controls.	29
Ch 3	PLF	PID Palette	Sets the PID palette 1 to 7.	43
Ch 4	PrG	Ramp/Soak	Sets the parameters concerning ramp/soak.	53
Ch 5	Non	Monitor	Allows you to confirm the status of the controller by checking each value. (Cannot be set.)	63
Ch 6	SEr	Setup	Sets the parameters concerning input/output.	71
Ch 7	SYS	System	Sets the parameters concerning system definitions for the controller.	89
Ch 8	ALN	Alarm	Sets the parameters concerning the alarm function.	111
Ch 9	CoN	Communication	Sets communication parameters such as the communication station number.	119
Ch10	PFb	Position Feedback (PFB)	Sets the parameters for motorized valve control.	125
Ch11	PRs	Password Setup	Controls password settings	131
Ch12	dSP	Display Mask for Each Parameter	Sets which parameters are displayed depending on the set value.	133
Ch13	CFG	Environmental Parameters(Config)	Sets the parameters concerning setup definitions for the controller.	141

● Setup Mode — Channel Menu

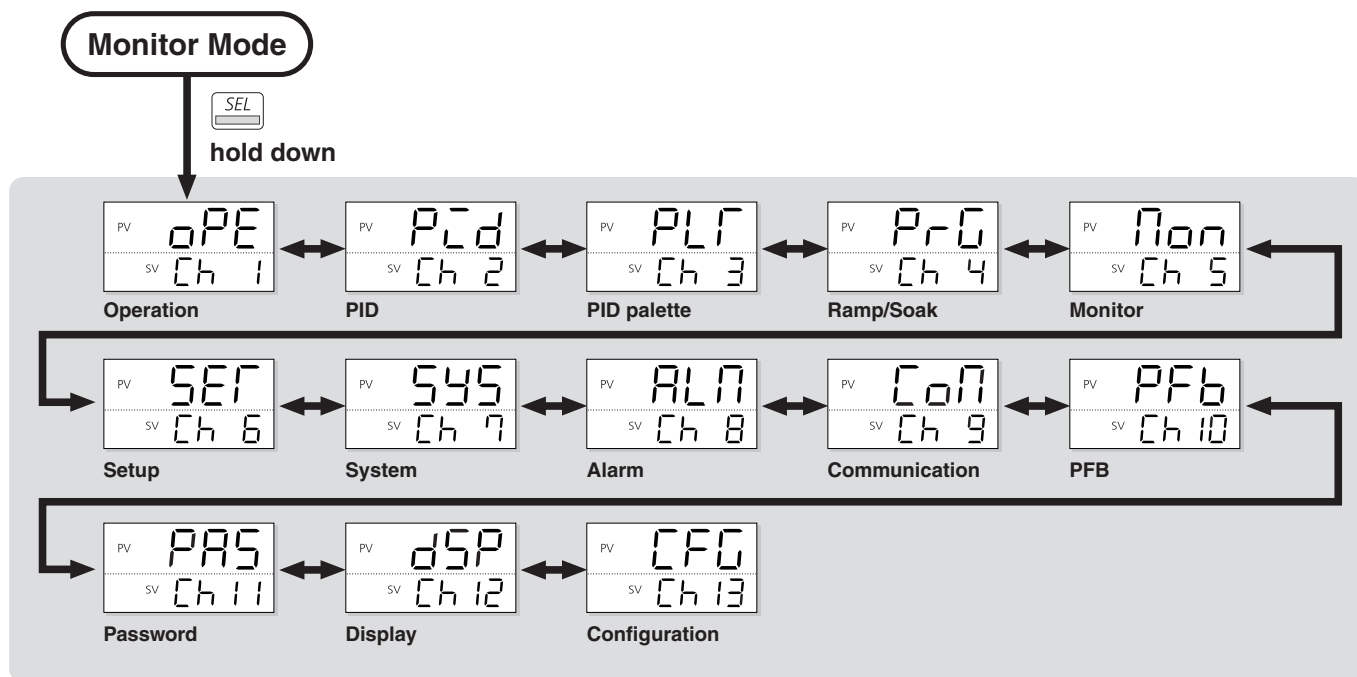

● Setup Mode — Parameter Menu

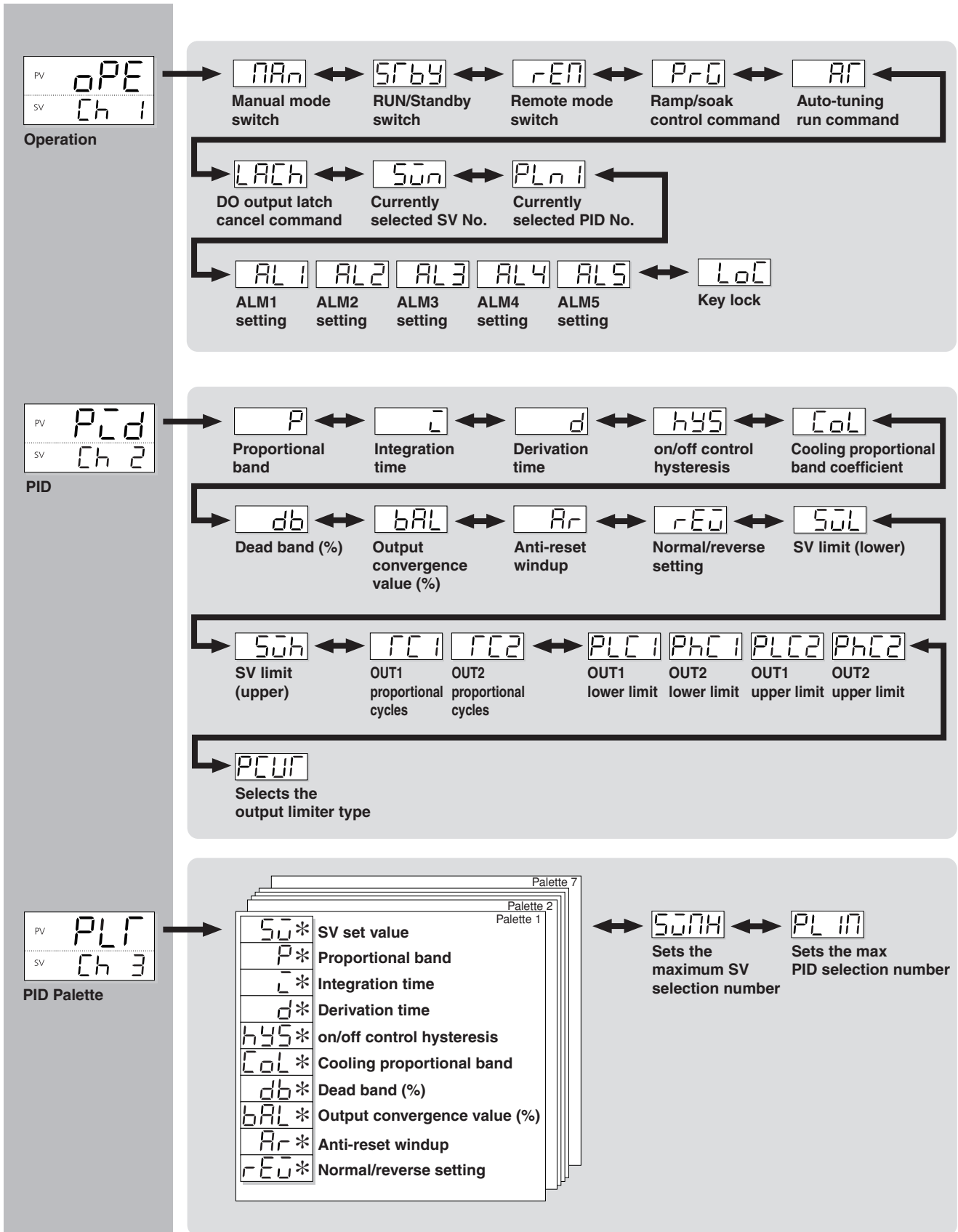

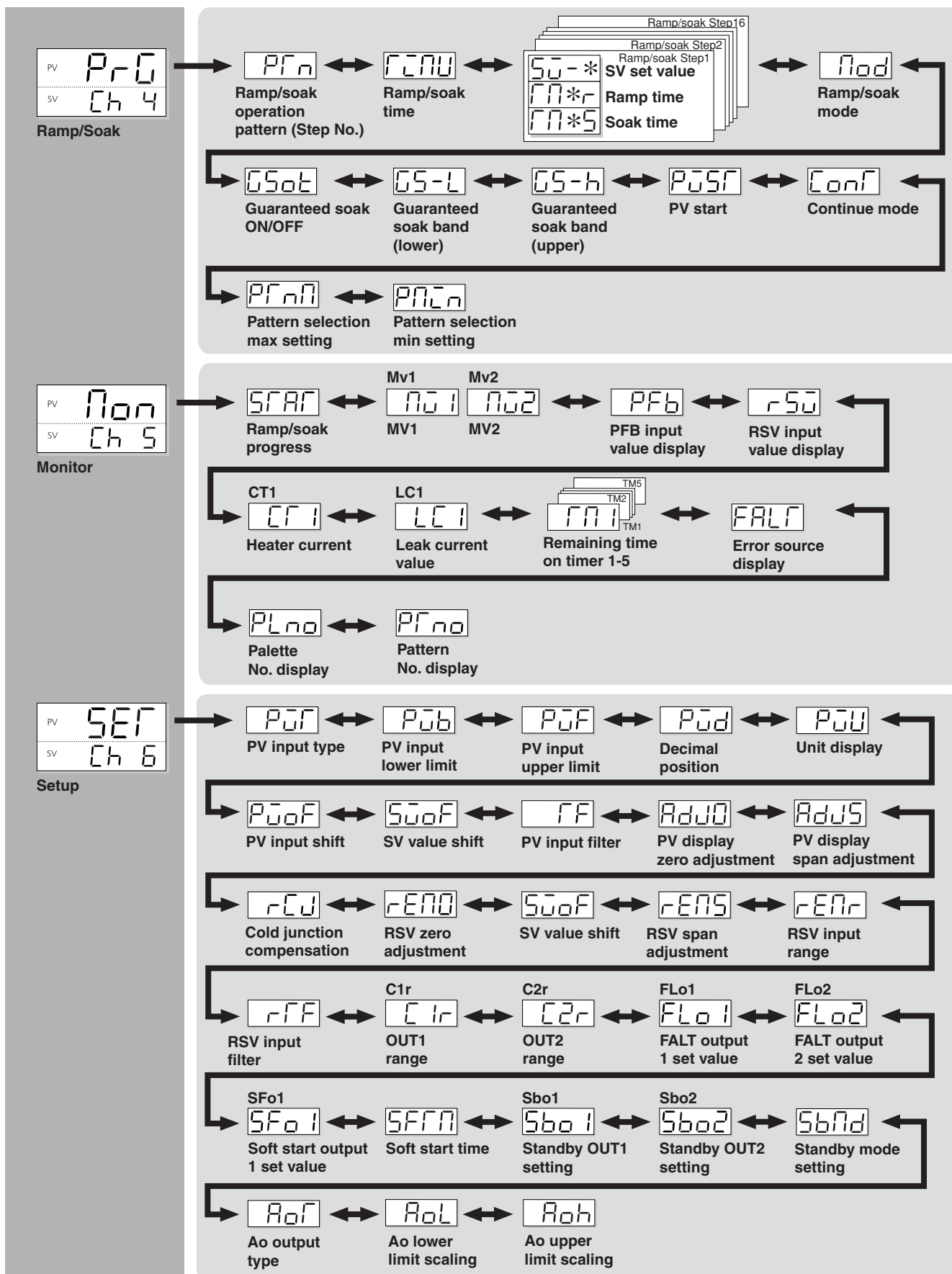

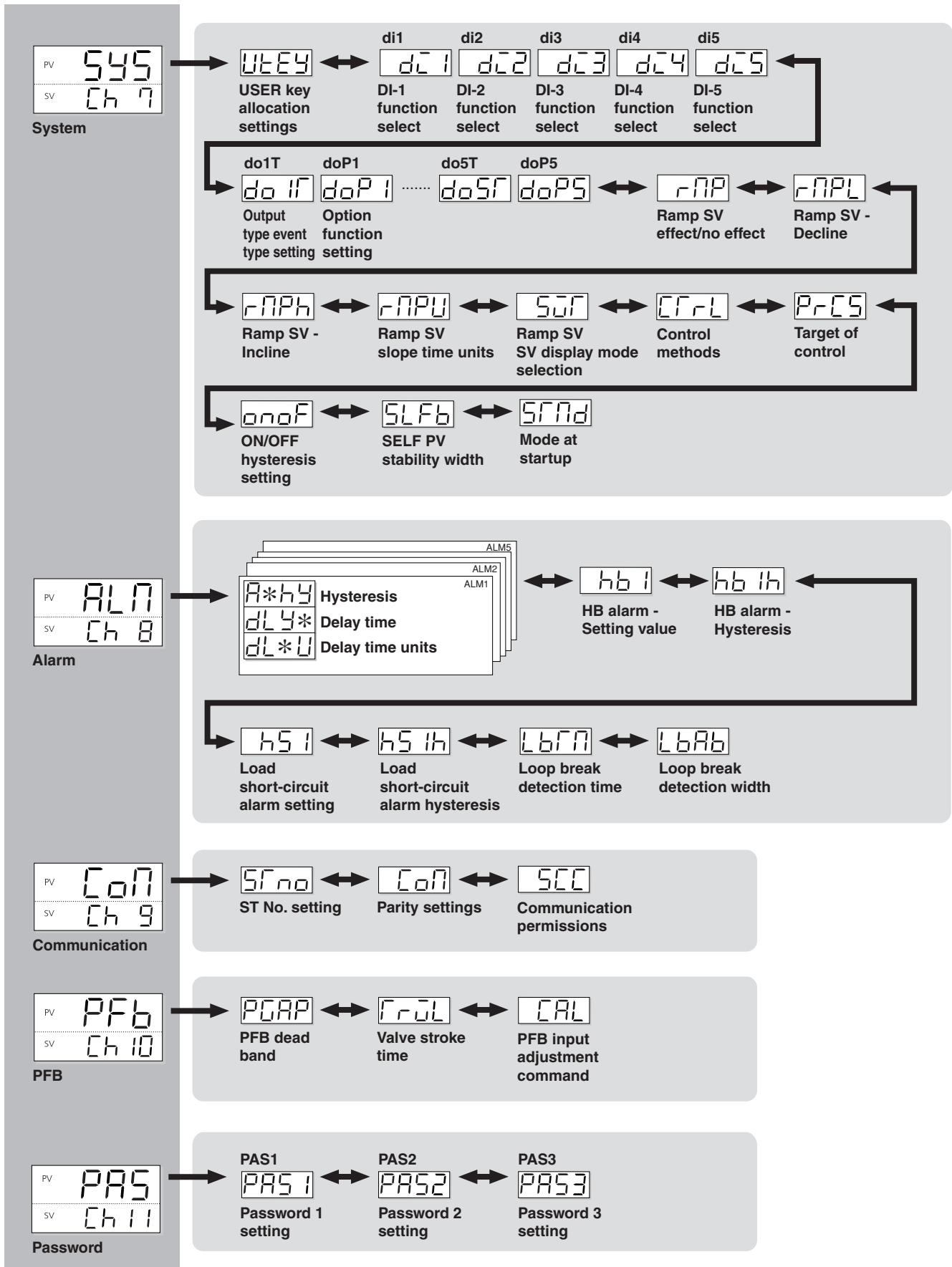

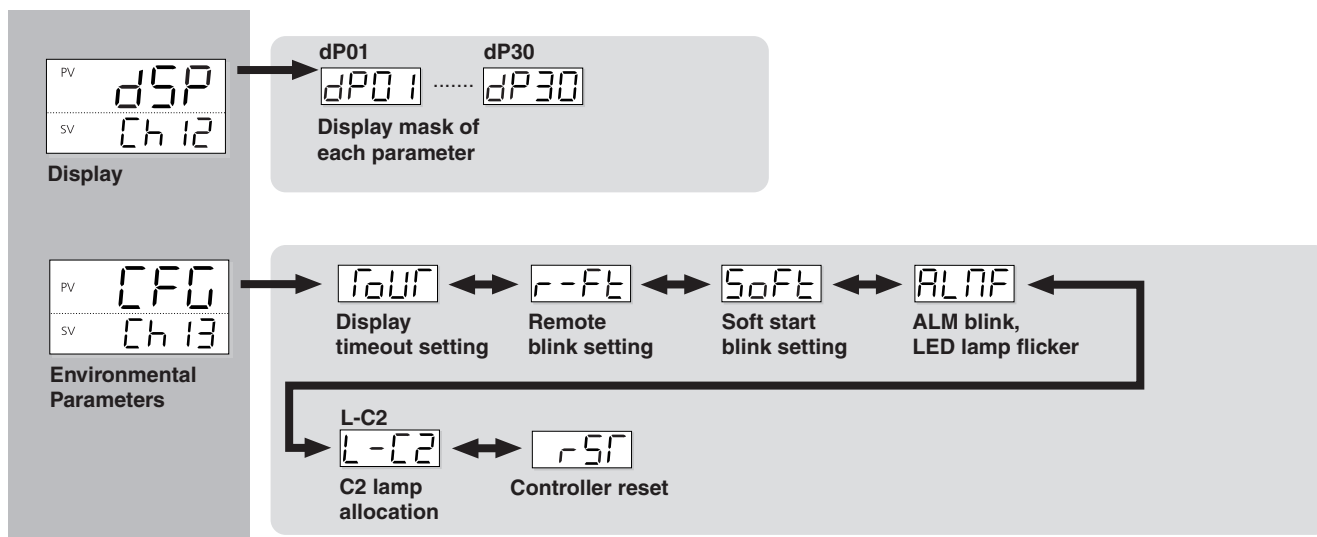

Steps for Setting Parameters

The following explains the steps from power-up to operation.

Prepare

1 Make a settings plan.

Decide how you want the controller to run and what parameter values will be needed to make the controller run to your specifications. At the very minimum, you need to determine the following settings:

- Input sensor type
- Normal or reverse operation

Refer to



"Normal/Reverse Settings" (p. 37)

- Control methods
Ex.) ON/OFF control, PID control

Refer to



"Proportional Bandwidth, Integration Time, Derivation Time" (p. 31)
"ON/OFF Control Hysteresis" (p. 32)

- SV Value

Refer to



"SV Lower limit" (p. 38)
"SV Upper limit" (p. 38)

2 Turn the power on.

Confirm that the connections are correct, then turn on the power.

Immediately after powering up, the controller will be in operation mode. The PV and SV displays will illuminate and display numbers. If nothing is displayed, recheck the power source and connection.

3 Switch to Setup Mode. Set the parameters laid out in your plan.

Refer to



Chapter 2 "Overview of Basic Operations and Parameters: Basic Operations" (p. 12)

Operation

1 Confirm that controlled object will operate in manual mode.

2 Test the controller with the auto-tuning or self-tuning functions. Adjust the parameters according to the results of the test.

MEMO

Chapter
2

Chapter 3

Operation Parameters (Ch1)

Overview of Operation Parameters (Ch1) – 22

Auto/Manual Switch – 23

Standby Switch – 24

Switching Between Local and Remote Operation – 24

Ramp/Soak Command – 25

Auto-tuning – 25

DO Output Latch Cancel – 26

SV No. Switch – 26

Changing PID No. – 27

Alarm Settings – 27

Key Lock – 28

Overview of Operation Parameters (Ch1)

Operation parameters handle all operation controls.

The operation menu includes the following items.

Display	Parameter name	Function	Setting range	Initial value	Remarks	Page
"MAn" (Man)	Switches to manual mode	Switches between auto/manual modes	oFF (off)/on (manual)	oFF		23
"STbY" (STbY)	Switches between RUN and standby	Switches the operation mode between run and standby	oFF (off)/on (standby)	oFF		24
"rEM" (rEM)	Switches to remote SV operation	Switches between local and remote SV operation	LoCL (Local)/rEM (Remote)	LoCL	(Note 1)	24
"PrG" (PrG)	Ramp/Soak Operation command	Switches between ramp/soak operation states	oFF (stop) rUn (run) hLd (hold)	oFF	Displays End when finished, and GS during guaranteed soak.	25
"AT" (AT)	Auto-tuning running command	Runs auto-tuning.	oFF (stop/finish) on (normal type) Lo (low PV type)	oFF		25
"LACH" (LACH)	Cancel command of the DO output latch	Cancels the DO output latch state	oFF/ rST (latch reset)	oFF	(Note 2)	26
"Svn" (Svn)	Selecting SV number during SV selection	Chooses the SV No. used for control	Sv0 (Local SV) Sv1 (SV=SV1) Sv2 (SV=SV2) Sv3 (SV=SV3) Sv4 (SV=SV4) Sv5 (SV=SV5) Sv6 (SV=SV6) Sv7 (SV=SV7) di (select SV based on di)	Sv0	(Note 4)	26
"PLn" (PLn1)	Currently selected PID No.	Chooses the PID group No. used for control	Pid0 (PID Ch) Pid1 (PID group No. 1) Pid2 (PID group No. 2) Pid3 (PID group No. 3) Pid4 (PID group No. 4) Pid5 (PID group No. 5) Pid6 (PID group No. 6) Pid7 (PID group No. 7) di (select Pid group No. based on di)	Pid0		27
"AL i" "AL iL" "AL ih" ⋮ "AL 5" "AL 5L" "AL 5h"	AL1 Setting AL1L Setting AL1h Setting ⋮ AL5 Setting AL5L Setting AL5h Setting	Sets the alarm set value.	0 to 100% FS (Absolute Alarm) -100 to 100% FS (Deviation Alarm)	10%	(Note 3)	27
"LoC" (LoC)	Key lock	Sets the key lock to prevent operation errors	0 (no lock) 1 (all lock) 2 (all but SV locked)	0		28

Note 1: Displays when the seventh digit of the model code is H, K, F, 2 or E, or the eleventh digit is D.

Note 2: Displays when the ninth digit of the model code is not 0, or the eleventh digit is C.

Note 3: The range of the parameters in the shaded area indicates the industrial values.

Note 4: When changing the SV value with the front panel key, do not change the "Svn" parameter with communication. The changed SV value may not be stored correctly.

MAN Auto/Manual Switch

Manual control allows you to set the control output to any value.

- Range off: Auto
on: Manual
- Manual Mode Display
A decimal point will light up at the bottom right of the display during manual mode. The same decimal point appears on the parameter setting display.
- Switching between Auto and Manual
 - Change from front panel:
In operation mode, press and hold the key to switch to manual mode. The bottom of the display shows the current manual output value, which can be changed with the keys.
 - Change from operation menu parameter ("oPE Ch 1")
Only switches between auto and manual modes. This operation cannot change the control output.

Refer to See "Communication Instruction Manual" for more about switching by the communication function.

● MV output flow diagram (MV output priority processing)

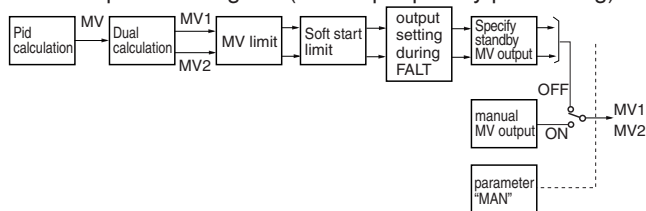

1. Changing Modes from the Front Panel

Operation mode

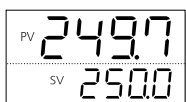

- 1 Press and hold the key.
The controller will switch from auto to manual.

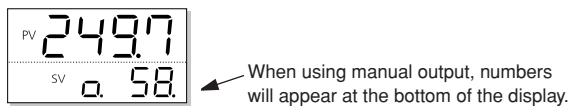

- 2 Use the keys to change the output value.
- 3 Press and hold the key again to return to auto mode.

Refer to See "USER Key Assignments" for more about setting the USER key (). (p. 93)

2. Changing Modes from the Channel Menu

Operation mode

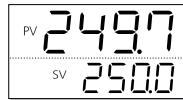

- 1 Press and hold the key to display "nU 1".
MV1 of the monitoring mode is displayed.

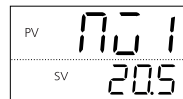

- 2 Press and hold the key to display the channel menu of the setting mode, then use the keys to display "oPE Ch 1".
Set the channel menu.

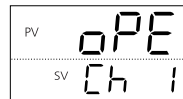

- 3 Press and hold the key, then use the keys to display MAN ("MAN").
Switch between auto and manual modes.

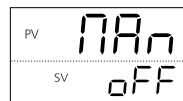

- 4 Press the key, then use the keys to display "on" when the lower part of the screen begins to blink.

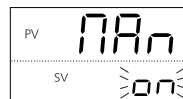

- 5 Press the key to confirm the setting.
This changes you to manual mode.
- 6 Press the key to return to the PV/SV display.

5rby Standby Switch

The following will switch you between operation mode and standby mode.

The following items can be set beforehand in standby mode.



- Control output (-3.0% to 103.0%)
- Alarm output (ON/OFF)
- Re-transmission output (ON/OFF)

Refer to  See "Standby Mode Settings" (p. 85) for more information about standby mode settings.

Point

- When "hold alarms" is on, the hold function activates when standby settings switch from on to off.
- If the controller is switched to standby mode during auto-tuning, auto-tuning will be cancelled. To complete auto-tuning, turn standby mode off and restart auto-tuning.
- When the controller switches to standby mode, the delay on timer will be reset. It will begin again when standby mode is turned off.

Switching Standby Mode

- 1 Press and hold the  key to display the channel menu of the setting mode, then use the   keys to display "oPE Ch 1".

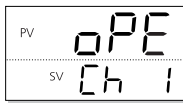



Refer to  See p. 23 in this chapter for information on how to display the channel menu.

- 2 Press and hold the  key, then use the   keys to select STbY ("5rby").

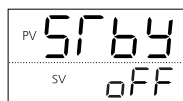
Switch between Run and Standby.



- 3 Press the  key, then use the   keys to display "on" when the lower part of the screen begins to blink.



- 4 Press the  key to confirm the setting.

Activate Standby Mode.

Control output, DO and other outputs are turned off.

- 5 Press the  key to return to the PV/SV display of the operation mode.

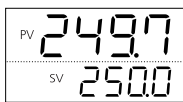



← The SV display blinks when in Standby Mode.

rEM Switching Between Local and Remote Operation

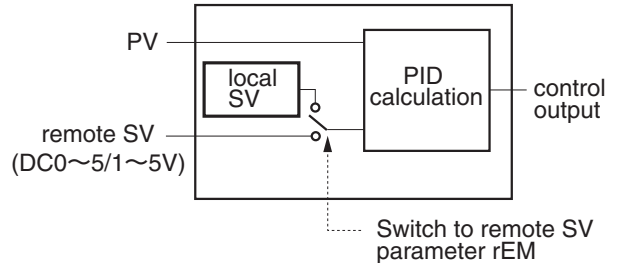
The following will switch you between local SV and remote SV operation. In remote SV operation, SV is controlled by an external SV input (RSV).



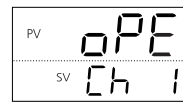

Switching Between Local and Remote Operation

- 1 Press and hold the  key to display the channel menu of the setting mode, then use the   keys to display "oPE Ch 1".





Refer to  See p. 23 in this chapter for information on how to display the channel menu.

- 2 Press and hold the  key, then use the   keys to display rEM ("rEM").

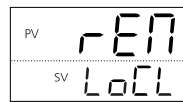
Change between local and remote operation.



- 3 Press the  key, then use the   keys to display "rEM" when the lower part of the screen begins to blink.

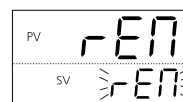

- 4 Press the  key to confirm the setting.

Activate remote operation.

- 5 Press the  key to return to the PV/SV display of the operation mode.



← "r50" and the RSV value alternate

Caution

In remote operation, the   keys on the front panel cannot be used to change SV.

Ramp/Soak Command

Switches between ramp/soak states.

The following three conditions are possible.



- "oFF" (stop) : The ramp/soak is stopped.
- "rUn" (run) : The ramp/soak starts.
- "hLd" (hold) : The ramp/soak holds. To release the hold, select "rUn" again.

The parameter information also changes automatically depending on the ramp/soak state.

- "oSS" (during guaranty soak): PV exceeds the range for guaranty soak when guaranty soak is on.
- "End" (end) : Ramp/soak ends.



Refer to  See "Chapter 6 Ramp/Soak Parameters" (p. 53) for more information on ramp/soak.

Activating the Ramp/Soak Command

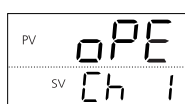

- 1 Press and hold the  key to display the channel menu of the setting mode, then use the   keys to display "oPE Ch 1".



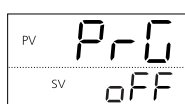

Refer to  See p. 23 in this chapter for information on how to display the channel menu.

- 2 Press and hold the  key, then use the   keys to display PrG ("PrG").

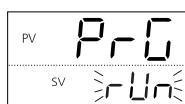

- 3 Press the  key, then use the   keys to display "rUn" when the bottom section of the screen begins to blink.



- 4 Press the  key to confirm the setting. The ramp/soak function will begin.

- 5 Press the  key to return to the PV/SV display of the operation mode.

Auto-tuning

Running auto-tuning automatically sets the optimal PID.

- Range oFF : Stop/Finish
 - on : Auto-tuning (normal type) starts
 - Lo : Auto-tuning (low PV type) starts



There are two types of auto-tuning.

Normal type	Requests PID and starts ON/OFF operation with SV as the baseline.
Low PV type	Requests PID and ON/OFF operation at a baseline of SV-10%. Use this setting if you are trying to prevent overshoot.

Caution ON/OFF control is performed during auto-tuning, so SV may be overshoot. If you are trying to minimize overshooting, use low PV auto-tuning.



Refer to  See "Control Methods" (p. 101) for more about auto-tuning.

Running Auto-tuning

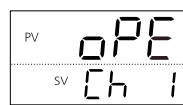

- 1 Press and hold the  key to display the channel menu of the setting mode, then use the   keys to display "oPE Ch 1".

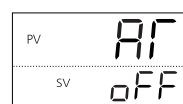

Refer to  See p. 23 in this chapter for information on how to display the channel menu.

- 2 Press and hold the  key, then use the   keys to select AT ("AT"). Select the type of auto-tuning.



- 3 Press the  key, then use the   keys to display "on" when the bottom part of the display begins to blink.

This selects normal auto-tuning.

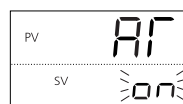

- 4 Press the  key to confirm the setting. Auto-tuning begins.

- 5 Press the  key to return to the PV/SV display of the operation mode.

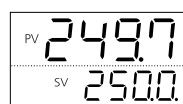

← A decimal point will blink in the bottom of the display during auto-tuning.

LACH

DO Output Latch Cancel

The following steps will cancel the DO Latch.

- Range: oFF
rST (latch reset)



- See "DO option Functions" (p. 98) for more information on DO latch settings.
- See "DI Functions Select" (p. 94) for more information on releasing the latch with DI.

Canceling the DO Output Latch

- 1 Press and hold the **SEL** key to display the channel menu of the setting mode, then use the **▲** **▼** keys to display "oPE Ch 1".

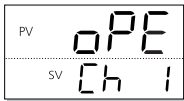

See p. 23 in this chapter for information on how to display the channel menu.

- 2 Press and hold the **SEL** key, then use the **▲** **▼** keys to display "LACH" ("LACH").



- 3 Press the **SEL** key, then use the **▲** **▼** keys to display "rST" when the bottom part of the display begins to blink.



- 4 Press the **SEL** key to confirm the setting. The following steps will cancel the DO Latch.

- 5 Press the **AM** key to return to the PV/SV display of the operation mode.

Svn SV No. Switch

This function changes an SV No. previously set to a PID palette. This allows SV to be changed easily.

- Range: Sv0, Sv1 ... Sv7, DI

Set the ramp SV when changing the SV to reduce frequency of loss of control.



See "Ramp SV decline, incline and slope time unit" (p. 99) for more information on ramp SV.

Caution

Changing the SV number will not change the control parameters (PID, etc). When changing the SV value with the front panel key, do not change the "Svn" parameter with communication. The changed SV value may not be stored correctly.

Changing SV Number

- 1 Press and hold the **SEL** key to display the channel menu of the setting mode, then use the **▲** **▼** keys to display "oPE Ch 1".

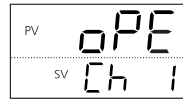

See p. 23 in this chapter for information on how to display the channel menu.

- 2 Press and hold the **SEL** key, then use the **▲** **▼** keys to display "Svn" ("Svn"). Change the SV number.

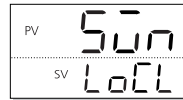

- 3 Press the **SEL** key, then use the **▲** **▼** keys to display "Sv3" when the bottom part of the display begins to blink.

In this example, change to "Sv3".



- 4 Press the **SEL** key to confirm the setting. The SV used for control is now set to "Sv3".

- 5 Press the **AM** key to return to the PV/SV display of the operation mode.



PLn1 Changing PID No.

The following changes a previously set PID No.

This allows you to change the PID No. to fit the SV and control settings.

- Range: Pid0, Pid1 ... Pid7, DI

Changing the PID No.

- 1 Press and hold the  key to display the channel menu of the setting mode, then use the   keys to display "oPE Ch 1".

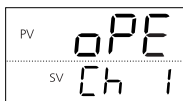



Refer to  See p. 23 in this chapter for information on how to display the channel menu.

- 2 Press and hold the  key, then use the   keys to display PLn1 ("PLn 1").

The PID No. is changed.



- 3 Press the  key, then use the   keys to display "Pid1" when the bottom part of the display begins to blink.

In this example, change to "Pid1".



- 4 Press the  key to confirm the setting. The PID calculation parameter used for control will change from PID0 to PID1.

- 5 Press the  key to return to the PV/SV display of the operation mode.

AL1 AL1L AL1H



Alarm Settings

The following steps set the values for ALM1 to ALM5 when DO1 to DO5 are set as alarms.

- Range: 0% to 100% FS

Refer to  See "Chapter 10 Alarm Parameters (Ch8)" (p. 107) for more information on delay time and alarm detection hysteresis

Setting Key Lock

- 1 Press and hold the  key to display the channel menu of the setting menu, then use the   keys to display "oPE Ch 1".

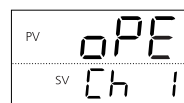



Refer to  See p. 23 in this chapter for information on how to display the channel menu.

- 2 Press and hold the  key, then use the   keys to select AL1 ("AL 1").

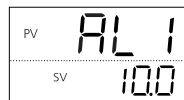
The alarm value for ALM1 is set.





- 3 Press the  key, then use the   keys to display "50.0" when the bottom part of the display begins to blink.

The alarm value is now set to "50°C".



- 4 Press the  key to confirm the setting. ALM1 alarm value is set to "50.0°C".

- 5 Repeat steps 2 to 4 (except pressing and holding the  key) to set through ALM5.

- 6 Press the  key to return to the PV/SV display of the operation mode.

LoC Key Lock

Prevents SV parameters from being changed.

The following three settings are available

- 0: No lock
- 1: All locked
- 2: All but SV locked

Point



The channel menu can be displayed even when key lock is active.

Refer to



Accidental operation can also be prevented with a password. See "Passwords 1 to 3" (p. 132) for more information about passwords.

Setting Key Lock



- 1 Press and hold the  key to display the channel menu of the setting mode, then use the   keys to display "oPE Ch 1".







Refer to

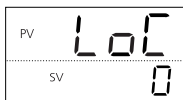

See p. 23 in this chapter for information on how to display the channel menu.

- 2 Press and hold the  key, then use the   keys to select LoC ("LoC").
Key Lock is now activated.



- 3 Press the  key, then use the   keys to display "2" when the bottom part of the display begins to blink.

All functions are locked except for changes to SV.



- 4 Press the  key to confirm the setting.

- 5 Press the  key to return to the PV/SV display of the operation mode.

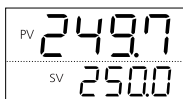

Chapter 4

Control (PID) Parameters (Ch2)

Overview of Control (PID) Parameters (Ch2) – 30
Proportional Band, Integration Time, Derivative Time – 31
ON/OFF Control Hysteresis – 32
Cooling Proportion Band Coefficient – 33
Dead Band – 34
Output Convergence Value – 35
Anti-reset Windup – 36
Normal/Reverse Setting – 37
SV Lower Limits, SV Upper Limits – 38
OUT1 Proportional Cycles, OUT2 Proportional Cycles – 39
OUT1 Upper/Lower Limits, OUT2 Upper/Lower Limits – 40
Setting Output Limiter Types – 41

Overview of Control (PID) Parameters (Ch2)

This section explains parameters related to PID and other controls.

The PID menu contains the following items.

Display	Parameter name	Function	Setting range	Initial value	Remarks	Page
"P" (P)	Proportional band	Sets the proportional band for the PID parameter. Setting to 0.0 will revert to ON/OFF control.	0.0% to 999.9%	5.0%		31
"I" (I)	Integration time	Sets the integration time for the PID parameter. Setting "0" will turn off integration.	0 sec to 3200 sec	240 sec		
"d" (d)	Derivative time	Sets the derivation time for the PID parameter. Setting "0.0" will turn off derivative.	0.0 sec to 999.9 sec	60.0 sec		
"hys" (hyS)	ON/OFF control hysteresis	Sets the hysteresis width for the on/off control.	0% to 50% FS	1°C		32
"CoL" (CoL)	Cooling proportional band coefficient	Sets the cooling proportional band coefficient Setting "0.0" will turn the cooling into an on/off control.	0.0 to 100.0	1.0	Note 1	33
"db" (db)	Dead band	Shifts the set value for the cooling proportional band	-50% to 50%	0%	Note 1	34
"bAL" (bAL)	Output convergence value	Offset value for calculating the MV output value	-100% to 100%	0/50 (single/dual)	Note 1	35
"Ar" (Ar)	Anti-reset windup	Sets the range of integration	0% to 100% FS	100%FS		36
"rEv" (rEv)	Sets normal/reverse operations	Sets the control output to normal or reverse	rv-- (heat (reverse) / cool (none)) no-- (heat (normal) / cool (none)) rvno (heat (reverse) / cool (normal)) norv (heat (normal) / cool (reverse)) rvrv (heat (reverse) / cool (reverse)) nono (heat (normal) / cool (normal))	rv--/rvno (single/dual)	RST	37
"SvL" (SvL)	SVlimit (lower)	Sets the lower limit for SV	0% to 100% FS	0% FS	Note 2	38
"SvH" (SvH)	SVlimit (upper)	Sets the upper limit for SV	0% to 100% FS	100% FS	Note 2	
"TC1" (TC1)	OUT1 proportion cycle	Sets the proportion cycle of the control output (OUT1) (Contact, SSR drive)	1 sec to 150 sec	30:Contact 2:SSR drive	Note 3	39
"TC2" (TC2)	OUT2 proportion cycle	Sets the proportion cycle of the control output (OUT2) (Contact, SSR drive)	1 sec to 150 sec	30:Contact 2:SSR drive	Note 1	
"PLC1" (PLC1)	OUT1 lower limit	Sets the lower limit of the control output (OUT1).	-3.0% to 103.0%	-3.0%		40
"PhC1" (PhC1)	OUT1 upper limit	Sets the upper limit of the control output (OUT1)	-3.0% to 103.0%	103.0%		
"PLC2" (PLC2)	OUT2 lower limit	Sets the lower limit of the control output (OUT2)	-3.0% to 103.0%	-3.0%	Note 1	41
"PhC2" (PhC2)	OUT2 upper limit	Sets the upper limit of the control output (OUT2)	-3.0% to 103.0%	103.0%	Note 1	
"PCUT" (PCUT)	Selects the output limiter type	Sets the type of output limiter	0 to 15	0		41

Note 1: Displays when the fifth digit of the model code is not S or V, and the sixth digit is A, C, E or P.

Note 2: Make sure to set the values for "SvL" and "SvH" so that SvL is less than SvH. When the set values of "SVL" and "SVH" are changed, adjust SV set value 1 ("Sv1 Ch3") through SV set value 7 ("Sv7 Ch3").

Note 3: Displays when the fifth digit of the model code is A or C.

Note 4: Turn off the power to the unit after changing the parameters with **RST** in the remarks column.

Note 5: The parameters in the shaded area indicates the industrial values.



Proportional Band, Integration Time, Derivative Time

Specifies PID (Proportional Band, Integration Time, Derivative Time)

- Range P : 0.0% to 999.9%
I : 0 sec to 3200 sec
D : 0.0 sec to 999.9 sec

The following control methods are available with PID settings.

ON/OFF (2 position) control	When PID parameter P = 0, ON/OFF control is used, regardless of the values for I and D. Use this function when you want to add simple controls without worrying about the controllability.
PID Control	Use this function when you want to control with high controllability. Operates when P ≠ 0, I ≠ 0, and D ≠ 0, but P, I, and D must be adjusted to optimal values for the control target. In normal situations, run auto-tuning to optimally adjust P, I, and D before using this function.
PI Control	When P ≠ 0, I ≠ 0, and D = 0, D control is turned off and PI control is used.
P Control	In principle, P control generates no offset and PV does not always equal SV. In this situation, adjust the output convergence value "bAL".

Point

- Running auto-tuning automatically sets PID. See "Auto-Tuning" (p. xx) for more information.
- The PID settings used during auto-tuning are the optimal settings. If you wish to change the responsiveness, adjust PID manually.
- Control normally becomes unstable when "Pm" is set too small. On the other hand, setting it too big makes the response slow.
- Set the hysteresis for the on/off control (2 state) with the parameter "h55".

Caution

Do not activate auto-tuning when using ON/OFF (2 state) control.

Setting PID

The following steps will explain how to set PID values, using as an example P=10.0%, I=100 sec and D=20 sec.

Operation mode



- 1 Press and hold the **SEL** key to display "MV I". MV1 of the monitoring mode is displayed.

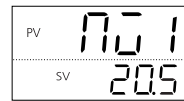

- 2 Press and hold the **SEL** key to display the setup mode channel menu ("dPE [h I]"), then use the **▲** **▼** keys to display Pid ("Pld [h 2]"). Specify the PID.

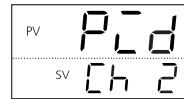

- 3 Press and hold the **SEL** key, then use the **▲** **▼** keys to display P ("P"). Specify P (Proportional Band)



- 4 Press the **SEL** key, then use the **▲** **▼** keys to set P to "10.0". when the bottom part of the display begins to blink.

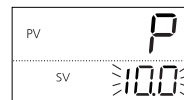

- 5 Press the **SEL** key to confirm the setting.

- 6 Repeat steps 3-5 (excluding pressing and holding the **SEL** key) for I and D.

- 7 Press the **AM** key to return to the operation mode PV/SV display.

hys ON/OFF Control Hysteresis

Settings for ON/OFF Control (2 position)

- Range: 0.0% to 50.0% FS

The control method varies with the size of the hysteresis.

Small hysteresis	<ul style="list-style-type: none"> • High-precision control • Frequency of output relays is high, so lifespan is short
Large hysteresis	<ul style="list-style-type: none"> • Low-precision control • Frequency of output relays is low, so lifespan is long

The relationship between SV and hysteresis in normal and reverse operation is shown below.

Reverse

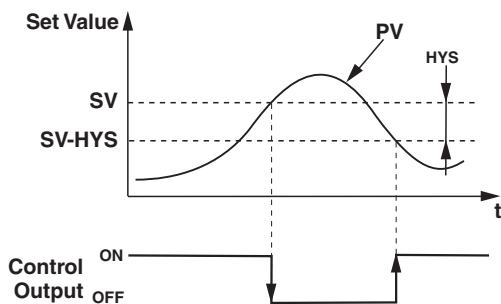

Normal

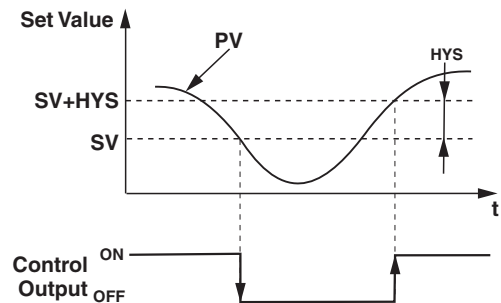

Point

- During ON/OFF control, the i and d settings do not affect control.
- The function operates as follows for manual operation during ON/OFF control:
 - Press the key: MV = 100%
 - Press the key: MV = 0%
- If the hysteresis width is narrow, and PV and SV are nearly equal, the output may frequently switch on and off. Note that doing so may affect the operation life of the contact output.

Setting ON/OFF Control Hysteresis

- 1 Press and hold the key to display the setup mode channel menu ("oPE [h 1]"), then use the keys to display Pid ("PId [h 2]").

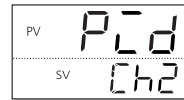

Refer to See p. 31 in this chapter for information on how to display the channel menu.

- 2 Press and hold the key to display P ("P") then use the keys to display hYS ("hYS"). ON/OFF control hysteresis is activated.

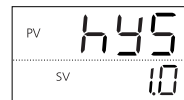

- 3 Press the key, then use the keys to set the ON/OFF control hysteresis to "2.5". The hysteresis is set to "2.5°C".

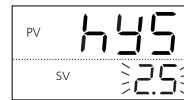

- 4 Press the key to confirm the setting.

- 5 Press the key to return to the operation mode PV/SV display.

Sets the cooling proportional band coefficient

- Range: 0.0 to 100.0

The relationship between heating control output and cooling control output is outlined below.

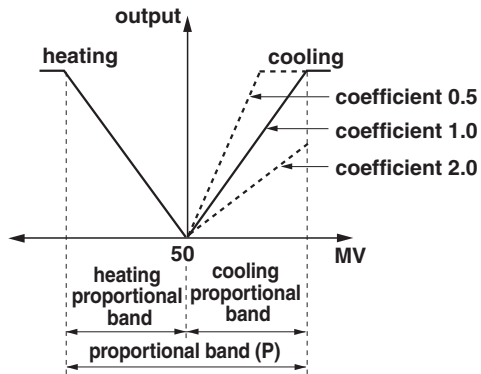

Cooling proportional band is set after the optimal value for heating proportional band is set.

$$\text{Cooling proportional band} = (\text{Proportional band}(P)/2) \times \text{Coefficient}$$

The following example shows how the cooling proportional band is calculated.

Example: What is the coefficient that will give a cooling proportional band of 10% when proportional band (P) = 50% with full scale cooling

$$10\% = (50\%/2) \times \text{Coefficient}$$

$$\text{Coefficient} = 0.4$$

To set cooling as a secondary operation, set "CoL" to 0.0. With two outputs set as P=0.0 and CoL=0.0, heating and cooling outputs become ON/OFF actions (2 state action). In this situation, the ON/OFF hysteresis is 0.5% FS (fixed) for heating and cooling outputs. The point of operation for the heating output can be shifted with the "hys" parameter. The point of operation for the cooling output can be shifted with the "db" parameter.

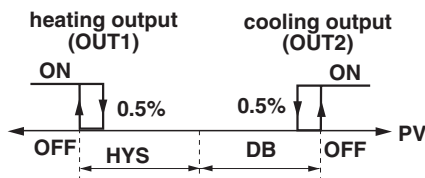

Caution This setting is valid when there are dual outputs. (The standard types are only units where the sixth digit of the model number is A, C, E, or P.)

Setting Cooling Proportional Band

- 1 Press and hold the **SEL** key to display the setup mode channel menu ("oPE Ch 1"), then use the **▲** **▼** keys to display Pid ("PId Ch 2").

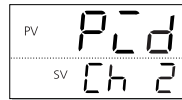

Refer to See p. 31 in this chapter for information on how to display the channel menu.

- 2 Press and hold the **SEL** key to display P ("P") then use the **▲** **▼** keys to display CoL ("CoL"). Specify the cooling proportional band coefficient.

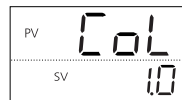

- 3 Press the **SEL** key, then use the **▲** **▼** keys to set the cooling proportional band to "2.5". The cooling proportional band is set to "2.5°C".

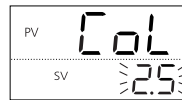

- 4 Press the **SEL** key to confirm the setting.

- 5 Press the **AM** key to return to the operation mode PV/SV display.

Cooling proportional band shifts with the setting value as shown below.

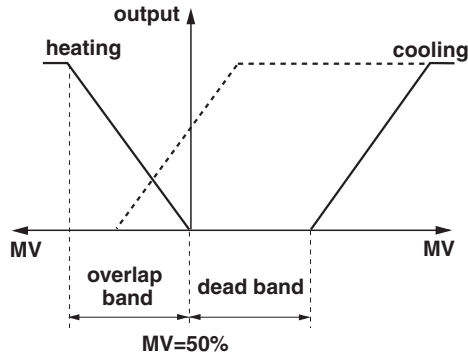

"db" is called dead band when the value is positive and overlap band when the value is negative.

- Range: -50% to 50%

"db" is measured as a percentage of MV and can be converted to a percentage variation by the following formula.

$$DB [\%] = \text{variation} \times \frac{100}{P} [\%]$$

Example: Proportional Band (P) = 5.0%, with a desired dead band of 1% variation from SV:

$$DB [\%] = 1.0 \times \frac{100}{5.0} = 20 [\%]$$

$$\text{Dead band} = 20 [\%]$$

Setting Dead Band

- 1 Press and hold the **SEL** key to display the setup mode channel menu ("oPE Ch 1"), then use the **▲** **▼** keys to display Pid ("PId Ch 2").

PV PId
SV Ch 2

Refer to



See p. 31 in this chapter for information on how to display the channel menu.

- 2 Press and hold the **SEL** key to display P ("P"), then use the **▲** **▼** keys to display db ("db").

Sets the dead band.

PV db
SV 00

- 3 Press the **SEL** key, then use the **▲** **▼** keys to set the cooling dead band to "1.5".

The cooling dead band is set to "1.5%".

PV db
SV 1.5

- 4 Press the **SEL** key to confirm the setting.

- 5 Press the **AM** key to return to the operation mode PV/SV display.

bAL Output Convergence Value

Output convergence value is a function that adds MV value offset.

- Range bAL : -100% to 100%
- The output convergence value function ("bAL") outputs to PV and SV a calculated result of the PID computed MV plus the bAL offset.
(The factory setting of bAL is 0% for single output, 50% for dual output.)

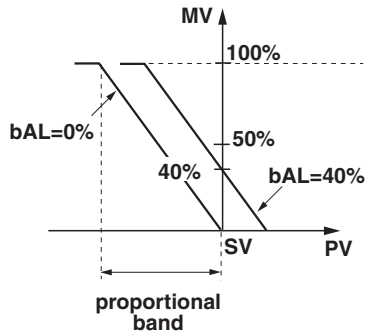

Setting the Output Convergence Value

- 1 Press and hold the **SEL** key to display the setup mode channel menu ("oPE Ch 1"), then use the **▲** **▼** keys to display Pid ("PId Ch 2").



Refer to  See p. 31 in this chapter for information on how to display the channel menu.

- 2 Press and hold the **SEL** key to display P ("P") then use the **▲** **▼** keys to display bAL ("bAL"). Set the output convergence value.

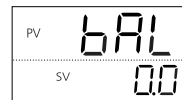

- 3 Press the **SEL** key, then use the **▲** **▼** keys to set the output convergence value to "3.0". The output convergence value is set to 3.0.

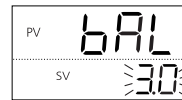

- 4 Press the **SEL** key to confirm the setting.

- 5 Press the **AM** key to return to the operation mode PV/SV display.

Ar Anti-reset Windup

Anti-reset windup is a function that limits the range of valid integration to control overshooting.

- Range Ar : 0% to 100% FS
- The anti-reset windup function ("Ar") cuts integration that falls outside of the Ar set range that is centered around SV. It is automatically set to the optimum value when auto-tuning is activated.

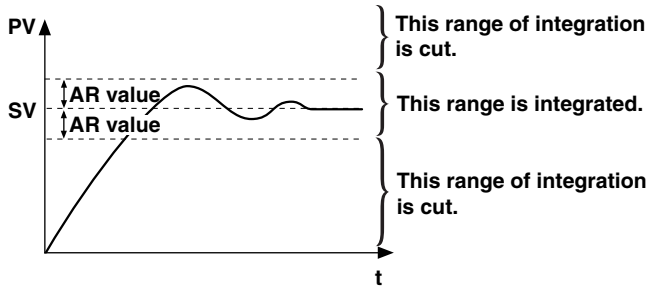

Caution

This controller implements fuzzy control. With fuzzy control, overshoot is minimized even if "bAL" and "Ar" are not used.

Setting the Anti-reset Windup

- 1 Press and hold the **SEL** key to display the setup mode channel menu ("oPE Ch 1"), then use the **▲** **▼** keys to display Pid ("Pid Ch 2").

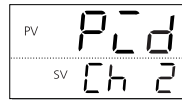

Refer to See p. 31 in this chapter for information on how to display the channel menu.

- 2 Press and hold the **SEL** key to display P ("P") then use the **▲** **▼** keys to display Ar ("Ar"). Set the anti-reset windup value.

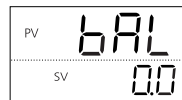

- 3 Press the **SEL** key, then use the **▲** **▼** keys to set anti-reset windup value to "500". The anti-reset windup value is set to "500°C".

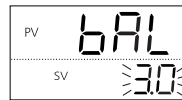

- 4 Press the **SEL** key to confirm the setting.

- 5 Press the **AM** key to return to the operation mode PV/SV display.

rEÜ Normal/Reverse Setting

Specifies whether the control operations are normal or reverse.

- Range rv-- : heat (reverse) / cool (none)
- no-- : heat (normal) / cool (none)
- rvno : heat (reverse) / cool (normal)
- norv : heat (normal) / cool (reverse)
- rvrv : heat (reverse) / cool (reverse)
- nono : heat (normal) / cool (normal)

Most temperature control is done with heating in reverse and cooling in normal.

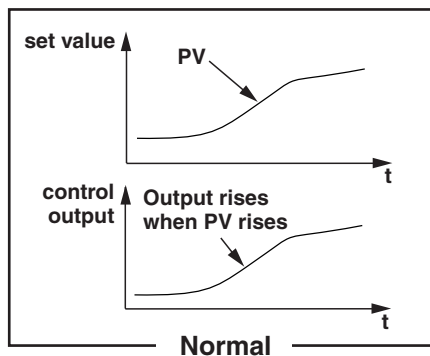
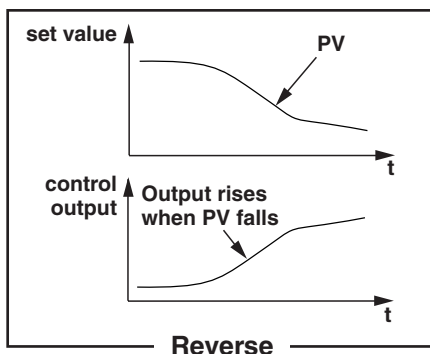

Setting the Normal/Reverse Setting

- 1 Press and hold the **SEL** key to display the setup mode channel menu ("oPE [h l]), then use the **▲** **▼** keys to display Pid ("Pld [h 2]).

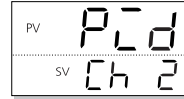

Refer to See p. 31 in this chapter for information on how to display the channel menu.

- 2 Press and hold the **SEL** key to display P ("P") then use the **▲** **▼** keys to display rEV ("rEÜ"). Normal/Reverse is set.

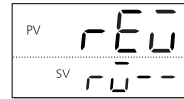

- 3 Press the **SEL** key, then use the **▲** **▼** keys to set the normal/reverse settings to "rvno" when the bottom part of the display begins to blink. With two outputs, heating is set to reverse and cooling is set to normal.

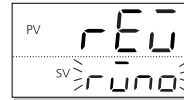

- 4 Press the **SEL** key to confirm the setting.

- 5 Press the **A/M** key to return to the operation mode PV/SV display.

SV Lower Limits

SV Upper Limits

These settings specify the range to which SV can be set. SV can be set to any value in the measurement range.

- Range: 0% to 100% FS (lower/upper limit)

The relationship between SV limits and the measurement range is as follows:

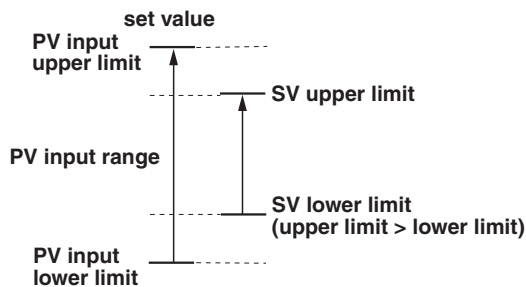



Caution

- Set the lower and upper SV limits only after setting the following parameters in the setup menu.
PV Input Upper Limit ("P_{UB}") / Lower Limit ("P_{LF}")
- SVs set before setting the SV limits (Local SV, Palette SV, etc.) are affected by new SV limits.
- Make sure to set the value of SVh greater than SVL.

Setting the SV Upper and Lower Limits

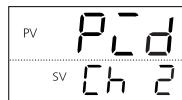
- 1 Press and hold the **SEL** key to display the setup mode channel menu ("oPE Ch 1"), then use the **▲** **▼** keys to display Pid ("P_{id} Ch 2").



Refer to  See p. 31 in this chapter for information on how to display the channel menu.

- 2 Press and hold the **SEL** key to display P ("P"), then use the **▲** **▼** keys to display SvL ("S_{VL}"). Specify the PV lower limit.

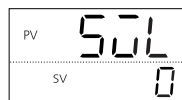

- 3 Press the **SEL** key, then use the **▲** **▼** keys to set the normal/reverse settings to "50" when the bottom part of the display begins to blink. The SV lower limit is set to 50°C.



- 4 Press the **SEL** key to confirm the setting.

- 5 Repeat steps 2-4 (excluding pressing and holding the **SEL** key) to set the SV upper limit.

- 6 Press the **A/M** key to return to the operation mode PV/SV display.

TC1 OUT1 Proportional Cycles

TC2 OUT2 Proportional Cycles

When using contact output and SSR drive output with PV input inside the proportional band, output will switch ON/OFF at regular intervals.

These intervals are called proportional cycles. OUT1 and OUT2 can be set separately.

- Range: 1 sec to 150 sec

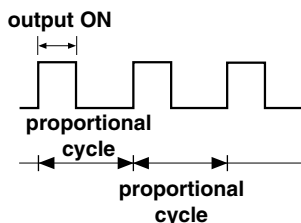

There are different recommended settings for different types of control output, as shown below.

Contact Output	The shorter the proportional cycle, the finer the control, however shorter proportional cycles also shorten the lifespan of the contact points and operating device. Be sure to balance control and controller lifespan when adjusting the proportional cycles. Approx.: 30 sec
SSR Drive Output	Because there are no mechanical parts to this controller, use a short proportional cycle if the operating device is working properly. Approx: 1 sec to 2 sec

Caution

- TC2 is only valid when there are dual outputs.
- It cannot be set for current output or voltage output.

Setting the Preset OUT1/OUT2 Values

- 1 Press and hold the **SEL** key to display the setup mode channel menu ("oPE Ch 1"), then use the **▲** **▼** keys to display Pid ("PId Ch 2").

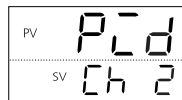

Refer to See p. 31 in this chapter for information on how to display the channel menu.

- 2 Press and hold the **SEL** key to display P ("P"), then use the **▲** **▼** keys to display TC1 ("fC 1"). Specify the proportional cycle for OUT1.

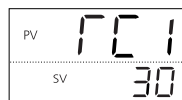

- 3 Press the **SEL** key, then use the **▲** **▼** keys to set the limit to 60. The proportional cycle for OUT1 is set to 60 seconds.

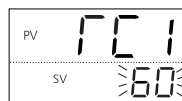

- 4 Press the **SEL** key to confirm the setting.

- 5 Repeat steps 2-4 (excluding pressing and holding the **SEL** key) to set the proportional cycle for OUT2.

- 6 Press the **AM** key to return to the operation mode PV/SV display.

PLC1 PHC1 OUT1 Upper/Lower Limits

PLC2 PHC2 OUT2 Upper/Lower Limits

This parameter specifies the upper and lower limits for output control.

- Setting range

Output	lower limit	upper limit	Setting range
OUT1	PLC1	PHC1	-3.0% to 103.0%
OUT2	PLC2	PHC2	-3.0% to 103.0%

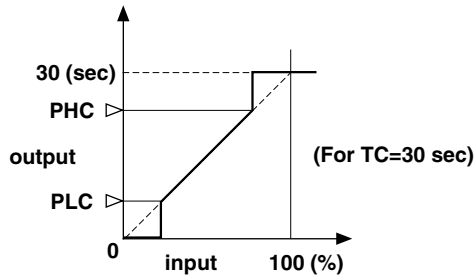

Refer to See "Setting Output Limiter Types" (p. 41) for more information on setting limits.

Setting OUT1/OUT2 Upper/Lower Limits

- 1 Press and hold the **SEL** key to display the setup mode channel menu ("oPE Ch 1"), then use the **▲** **▼** keys to display Pid ("PLd Ch 2").

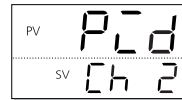

Refer to See p. 31 in this chapter for information on how to display the channel menu.

- 2 Press and hold the **SEL** key to display P ("P"), then use the **▲** **▼** keys to display PLC1 ("PLC 1"). Specify the lower limit for OUT1.



- 3 Press the **SEL** key, then use the **▲** **▼** keys to set the limit to 5.0.

The lower limit for OUT1 is set to 5.



- 4 Press the **SEL** key to confirm the setting.

- 5 Repeat steps 2-4 (excluding pressing and holding the **SEL** key) to set the upper limit for OUT1 and the upper and lower limits for OUT2.

- 6 Press the **AM** key to return to the operation mode PV/SV display.

PCUR Setting Output Limiter Types

When a limit is specified for the output value, you can choose whether or not to apply the limit.

The output changes according to the limit, as follows.

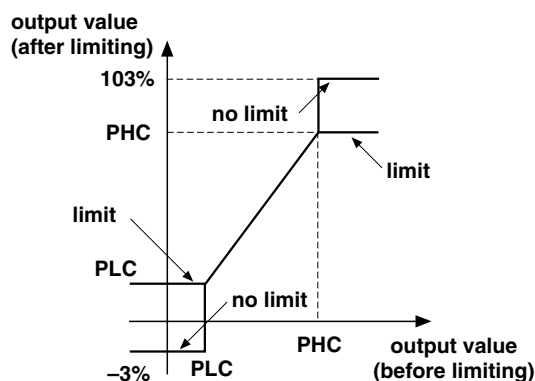

Range can vary according to the following table.

Setting	Output 1 (OUT1)		Output 2 (OUT2)	
	lower limit	upper limit	lower limit	upper limit
0	-3%	103%	-3%	103%
1	limit	103%	-3%	103%
2	-3%	limit	-3%	103%
3	limit	limit	-3%	103%
4	-3%	103%	limit	103%
5	limit	103%	limit	103%
6	-3%	limit	limit	103%
7	limit	limit	limit	103%
8	-3%	103%	-3%	limit
9	limit	103%	-3%	limit
10	-3%	limit	-3%	limit
11	limit	limit	-3%	limit
12	-3%	103%	limit	limit
13	limit	103%	limit	limit
14	-3%	limit	limit	limit
15	limit	limit	limit	limit

Setting Output Limiters

- 1 Press and hold the **SEL** key to display the setup mode channel menu ("oPE Ch 1"), then use the **▲** **▼** keys to display Pid ("PId Ch 2").

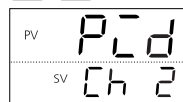

Refer to See p. 31 in this chapter for information on how to display the channel menu.

- 2 Press and hold the **SEL** key to display P ("P"), then use the **▲** **▼** keys to display PCUR ("PCUR"). Sets the output limiter types.

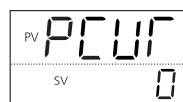

- 3 Press the **SEL** key, then use the **▲** **▼** keys to set the limit to 15. All of the outputs are limited.



- 4 Press the **SEL** key to confirm the setting.

- 5 Press the **AM** key to return to the operation mode PV/SV display.

MEMO

Chapter 5

PID Palette Parameter (Ch3)

Overview of PID Palette Parameters (Ch3) – 44

SV Set Value – 46

Proportional Band, Integration Time, Derivative Time – 47

ON/OFF Control Hysteresis – 48

Cooling Proportional Band – 48

Dead Band – 49

Output Convergence Value – 49

Anti-reset Windup – 50

Normal/Reverse Setting – 50

Setting the Maximum SV Selection Number – 51

Setting the Maximum PID Selection Number – 51

Overview of PID Palette Parameters (Ch3)

This function records SV and control parameters such as PID. Any of the up to 7 sets stored can be easily recalled by using their number.

This is very useful when operating conditions change frequently.

The palette menu (ch3) consists of the following function blocks.:

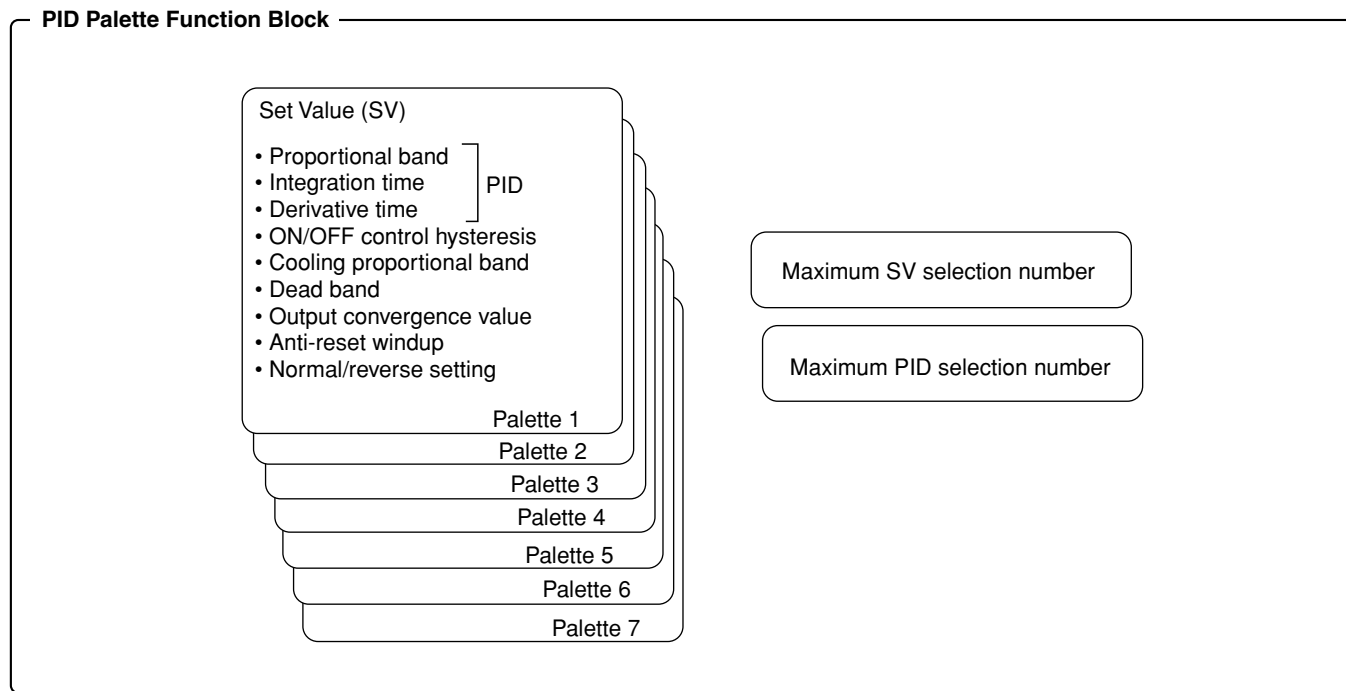

Chapter
5

Refer to



To change the SV No. or PID No., refer to "SV No. Switch" (page 26), "Changing PID No." (page 27), or "DI Function Select" (page 94).

Display	Parameter name	Function	Setting range	Initial value	Remarks	Page
"SV1" (Sv1)	SV set value 1	Sets the SV value	SV lower limit (SVL) to SV upper limit (SVH) %FS	0%FS	Note 1	46
"P1" (P1)	Proportional band 1	Sets the proportional band	0.0% to 999.9%	5.0%		47
"i1" (i1)	Integration time 1	Sets the integration time	0 sec to 3200 sec	240 sec		47
"d1" (d1)	Derivative time 1	Sets the derivative time	0.0 sec to 999.9 sec	60.0 sec		47
"hyS1" (hyS1)	ON/OFF Control Hysteresis 1	Sets the hysteresis when using ON/OFF control	0% to 50% FS	1°C		48
"CoL1" (CoL1)	Cooling proportional band 1	Sets the cooling proportional band	0.0 to 100.0	1.0	Note 2	48
"db1" (db1)	Dead band 1	Sets the dead band	-50.0% to 50.0% FS	0%	Note 2	49
"bAL1" (bAL1)	Output convergence value 1	Offset value added to the control output	-100.0% to 100.0% FS	0/50 (single/dual)		49
"Ar1" (Ar1)	Anti-reset windup 1	Sets the anti-reset windup	0% to 100% FS	100%FS		50
"rEv1" (rEv1)	Normal/reverse setting 1	Sets the control output to normal or reverse	rv-- (heat (reverse) / cool (none)) no-- (heat (normal) / cool (none)) rvno (heat (reverse) / cool (normal)) norv (heat (normal) / cool (reverse)) rvrv (heat (reverse) / cool (reverse)) nono (heat (normal) / cool (normal))	rv-/rvno (single/dual)	Note 3 RST	50
⋮	⋮	⋮	⋮	⋮	⋮	⋮
"SV7" (Sv7)	SV set value 7	Sets the SV value	SV lower limit (SVL) to SV upper limit (SVH) %FS	0%FS	Note 1	46
"P7" (P7)	Proportional band 7	Sets the proportional band	0.0% to 999.9%	5.0%		47
"i7" (i7)	Integration time 7	Sets the integration time	0 sec to 3200 sec	240 sec		47

Display	Parameter name	Function	Setting range	Initial value	Remarks	Page
"d7" (d7)	Derivative time 7	Sets the derivative time	0.0 sec to 999.9 sec	60.0 sec		47
"hyS7" (hyS7)	ON/OFF control hysteresis7	Sets the hysteresis when using ON/OFF control	0% to 50% FS	1°C		48
"CoL7" (CoL7)	Cooling proportional band 7	Sets the cooling proportional band	0.0 to 100.0	1.0	Note 2	48
"db7" (db7)	Dead band 7	Sets the dead band	-50.0% to 50.0%	0%	Note 2	49
"bAL7" (bAL7)	Output convergence value 7	Offset value added to the control output	-100.0% to 100.0%	0/50 (single/dual)		49
"Ar7" (Ar7)	Anti-reset windup 7	Sets the anti-reset windup	0% to 100% FS	100%FS		50
"rEv7" (rEv7)	Normal/reverse setting 7	Sets the control output to normal or reverse	rv-- (heat (reverse) / cool (none)) no-- (heat (normal) / cool (none)) rvno (heat (reverse) / cool (normal)) norv (heat (normal) / cool (reverse)) rvrv (heat (reverse) / cool (reverse)) nono (heat (normal) / cool (normal))	rv--/rvno (single/dual)	Note 3 RST	50
"SvMX" (SvMX)	Sets the maximum SV selection number	Sets the maximum selectable number when selecting SV with the user key.	Sv0 (Local SV) Sv1 (SV=SV1) Sv2 (SV=SV2) Sv3 (SV=SV3) Sv4 (SV=SV4) Sv5 (SV=SV5) Sv6 (SV=SV6) Sv7 (SV=SV7) di (SV = Di Selected)	Sv7		51
"PL #7" (PL1M)	Sets the max PID selection number	Sets the maximum selectable number when selecting PID with the user key.	Pid0 (PID ch) Pid1 (PID group No. 1) Pid2 (PID group No. 2) Pid3 (PID group No. 3) Pid4 (PID group No. 4) Pid5 (PID group No. 5) Pid6 (PID group No. 6) Pid7 (PID group No. 7) di: PID group Di selected	Pid7		51

Note 1: Make sure to set the values for "SVL" and "SVH" so that SvL is less than SvH. When the set values of "SVL" and "SVH" are changed, adjust SV set value 1 ("Sv1 Ch3") through SV set value 7 ("Sv7 Ch3").

Note 2: Displays when the fifth digit of the model number is not S or V, and the sixth digit is A, C, E, or P.

Note 3: Set to the same value as the Normal/Reverse Operations setting ("rEV CH2").

Note 4: Turn off the power to the unit after changing the parameters with **RST** in the remarks column.

Note 5: The range of the parameters in the shaded area indicates the industrial values.

SV1 to SV7 SV Set Value

Up to seven types of SV (SV1-SV7) can be recorded. Recorded SVs can be recalled from SV selection ("SVn") in the operation menu.

- Range: SV lower limit (SVL) to SV upper limit (SVH)%FS

Point Use the ramp SV function of the system menu ("SYS Ch 7") to prevent loss of control when switching SV numbers.

Refer to See "SV No. Switch" (p. 26) for more information about selecting SV, local SV and changing SV with DI.

Setting SV

The following steps will explain how to set SV1 to 300°C as an example.

Operation mode

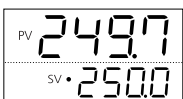

- 1 Press and hold the **SEL** key to display "MV 1".
The MV output of the monitoring mode is displayed.



- 2 Press and hold the **SEL** key to display the setup mode channel menu ("OP Ch 1") then use the **▲** **▼** keys to display PLT ("PLT Ch 3").
Specify the palette menu.

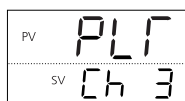

- 3 Press and hold the **SEL** key, then use the **▲** **▼** keys to display Sv1 ("SV 1").
Set SV No. 1.

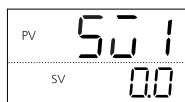

- 4 Press the **SEL** key, then use the **▲** **▼** keys to set SV to 300.0 when the bottom part of the display begins to blink.
SV1 is set to 300.0°C.



- 5 Press the **SEL** key to confirm the setting.

- 6 Repeat steps 3 to 5 (excluding pressing and holding the **SEL** key) to set SV2 to SV7.

- 7 Press the **AM** key to return to the operation mode PV/SV display.

P1 to P7 Proportional Band

i1 to i7 Integration Time

d1 to d7 Derivative Time

The following steps set PID. Up to seven types of PID (palettes 1 to 7) can be recorded. Recorded PIDs can be recalled from selected PID number ("PLn l") in the operation menu Ch1.

- Range Proportional Bandwidth(P) : 0.0% to 999.9%
- Integration Time(I) : 0 sec to 3200 sec
- Derivation Time(D) : 0.0 sec to 999.9 sec

Refer to See "Proportional Band, Integration Time, Derivation Time" (p. 31) for more details on PID.

- When the PID No. is changed, the following parameters change to match it.
 - ON/OFF control hysteresis
 - Cooling proportional band
 - Dead band
 - Output Convergence Value
 - Anti-reset windup
 - Normal/Reverse Setting
- Running auto-tuning will automatically set the selected PID No. into the selected PID parameter.

Caution

- For safety reasons, make sure to turn off power to the system when switching the normal/reverse operations while using the PID selection function. (Do not switch between normal and reverse operation while controlling.)
- If "(PID No. +1, SV No. +1 (increment))" function is executed under the "PID No. ≠ SV No.", PID No. and SV No. is automatically set to same value.
- PID is switched using the palette units. They cannot be combined and used with a different palette's PID.

Setting PID

- 1 Press and hold the **SEL** key to display the setup mode channel menu ("oPE Ch l"), then use the **▲** **▼** keys to display PLT ("PLT Ch 3").

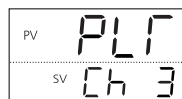

Refer to See p. 46 in this chapter for information on how to display the channel menu.

- 2 Press and hold the **SEL** key to display the SV parameter ("Sv l"), then use the **▲** **▼** keys to display P1 ("P l").

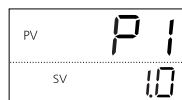

- 3 Press the **SEL** key, then use the **▲** **▼** keys to set P1 to "10.0" when the bottom part of the display begins to blink.

This sets the value to 10.0%.

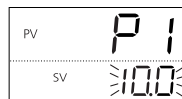

- 4 Press the **SEL** key to confirm the setting.

- 5 Repeat steps 2 to 4 (excluding pressing and holding the **SEL** key) to set i1 and d1.

- 6 Press the **AIM** key to return to the operation mode PV/SV display.

hYS1 to hYS7

ON/OFF Control Hysteresis

The following sets the hysteresis during ON/OFF control. Up to seven types of hysteresis (palettes 1 to 7) can be recorded. Recorded hysteresis can be recalled from selected PID number ("PLn I") in the operation menu.

- Range: 0% to 50% FS



See "ON/OFF Hysteresis Control" (p. 32) for more information about ON/OFF control hysteresis.

Point

When PID parameter P = 0, ON/OFF control is used.

Setting ON/OFF Control Hysteresis

The following steps explain how to set ON/OFF hysteresis control using 3.0°C as an example.

- 1 Press and hold the key to display the setup mode channel menu ("oPE Ch I") then use the keys to display PLT ("PLT Ch 3").



See p. 46 in this chapter for information on how to display the channel menu.

- 2 Press and hold the key to display the SV parameter ("Sv I"), then use the keys to display hYS1 ("hYS I").

- 3 Press the , then use the keys to set ON/OFF control hysteresis to 3.0 when the bottom part of the display begins to blink. The hysteresis is set to 3.0°C.

- 4 Press the key to confirm the setting.

- 5 Press the key to return to the operation mode PV/SV display.

CoL1 to CoL7

Cooling Proportional Band

Sets the cooling proportional band when dual outputs are selected. Up to seven types of cooling proportional band (palettes 1 to 7) can be recorded. Recorded cooling proportional band can be recalled from selected PID number ("PLn I") in the operation menu.

- Range: 0.0 to 100.0



See "Cooling Proportional Band Coefficient" (p. 33) for more information about cooling proportional band.

Setting Cooling Proportional Band

The following steps explain how to set cooling proportional band using 5.0% as an example.

- 1 Press and hold the key to display the setup mode channel menu ("oPE Ch I") then use the keys to display PLT ("PLT Ch 3").



See p. 46 in this chapter for information on how to display the channel menu.

- 2 Press and hold the key to display the SV parameter ("Sv I"), then use the keys to display CoL1 ("CoL I").

- 3 Press , then use the keys to set the cooling proportional band to "5.0". The cooling proportional band is set to 5.0.

- 4 Press the key to confirm the setting.

- 5 Press the key to return to the operation mode PV/SV display.

db1 to db7 Dead Band

Sets the dead band when dual outputs are selected. Up to seven types of dead band (palettes 1 to 7) can be recorded. Recorded dead band can be recalled from selected PID number ("PLn l") in the operation menu.

- Range: -50.0% to 50.0%

Refer to



See "Dead Band" (p. 34) for more information on dead band.

Setting Dead Band

The following steps explain how to set dead band by using 7.0% as an example.

- 1 Press and hold the **SEL** key to display the setup mode channel menu ("oPE Ch l") then use the **▲** **▼** keys to display PLT ("PLT Ch 3").



Refer to



See p. 46 in this chapter for information on how to display the channel menu.

- 2 Press and hold the **SEL** key to display the SV parameter ("Sū l"), then use the **▲** **▼** keys to display db1 ("db l").

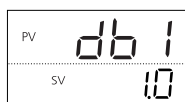

- 3 Press the **SEL** key, then use the **▲** **▼** keys to set dead band to 7.0 when the bottom part of the display begins to blink.

The dead band is set to 7.0%.



- 4 Press the **SEL** key to confirm the setting.

- 5 Press the **AIM** key to return to the operation mode PV/SV display.

bAL1 to bAL7

Output Convergence Value

Sets the output convergence value. Up to seven types of output convergence value (palettes 1 to 7) can be recorded. Recorded output convergence value can be recalled from selected PID number ("PLn l") in the operation menu.

- Range: -100.0% to 100.0%

Refer to



See "Output Convergence Value" (p. 35) for more information on output convergence values.

Setting the Output Convergence Value

This section explains how to set the output convergence value by using -5.5% as an example.

- 1 Press and hold the **SEL** key to display the setup mode channel menu ("oPE Ch l") then use the **▲** **▼** keys to display PLT ("PLT Ch 3").

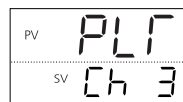

Refer to



See p. 46 in this chapter for information on how to display the channel menu.

- 2 Press and hold the **SEL** key to display the SV parameter ("Sū l"), then use the **▲** **▼** keys to display bAL1 ("bAL l").

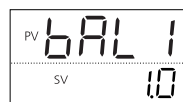

- 3 Press the **SEL** key, then use the **▲** **▼** keys to set the output convergence value to -5.5 when the bottom part of the display begins to blink.

The output convergence value is set to -5.5%.

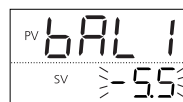

- 4 Press the **SEL** key to confirm the setting.

- 5 Press the **AIM** key to return to the operation mode PV/SV display.

Ar1 to Ar7

Anti-reset Windup

Sets the anti-reset windup. Up to seven types of anti-reset windup (palettes 1 to 7) can be recorded. Recorded anti-rest windup can be recalled from selected PID number ("PLn I") in the operation menu.

- Range: 0.0% to 100.0%



See "Anti-reset Windup" (p. 36) for more information on the anti-reset windup.

Setting the Anti-reset Windup

The following steps explain how to set the anti-reset windup by using 200°C as an example.

- 1 Press and hold the key to display the setup mode channel menu ("oPE Ch I") then use the keys to display PLT ("PLT Ch 3").

PV PLT
SV Ch 3



See p. 46 in this chapter for information on how to display the channel menu.

- 2 Press and hold the key to display the SV parameter ("Sū I"), then use the keys to display Ar1 ("Ar I").

PV Ar 1
SV 4000

- 3 Press the key, then use the keys to display "200.0" when the bottom part of the display begins to blink.

Anti-reset windup is set to 200.0°C.

PV Ar 1
SV 200.0

- 4 Press the key to confirm the setting.

- 5 Press the key to return to the operation mode PV/SV display.

rEv1 to rEv7

Normal/Reverse Setting

The following sets the normal/reverse setting. Up to seven types of normal/reverse settings (palettes 1 - 7) can be recorded. Recorded normal/reverse settings can be recalled from selected PID number ("PLn I") in the operation menu.

Range	Control Operation
rv--	(heat (reverse) / cool (none))
no--	(heat (normal) / cool (none))
rvno	(heat (reverse) / cool (normal))
norv	(heat (normal) / cool (reverse))
rvrv	(heat (reverse) / cool (reverse))
nono	(heat (normal) / cool (normal))



See "Normal/Reverse Settings" (p. 37) for more information on normal/reverse settings.

Setting the Normal/Reverse Setting

The following steps explain how to set normal/reverse settings by using heat (reverse) / cool (normal) as an example.

- 1 Press and hold the key to display the setup mode channel menu ("oPE Ch I") then use the keys to display PLT ("PLT Ch 3").

PV PLT
SV Ch 3



See p. 46 in this chapter for information on how to display the channel menu.

- 2 Press and hold the key to display the SV parameter ("Sū I"), then use the keys to display rEv1 ("rEv I").

PV rEv 1
SV rü--

- 3 Press the key, then use the keys to select "rvno" when the bottom part of the display begins to blink.

The normal/reverse setting is now set to heat (reverse) / cool (normal).

PV rEv 1
SV rvno

- 4 Press the key to confirm the setting.

- 5 Press the key to return to the operation mode PV/SV display.

Point

For safety reasons, make sure to turn off power to the system when switching the normal/reverse operations while using the PID selection function. (Do not switch between normal and reverse operation while controlling.)

Setting the Maximum SV Selection Number

The following sets the maximum number that can be switched to when switching the SV No. via the USER key.

- Range: SV0 to SV7, di

Refer to See "USER Key Assignments" (p.93) for more information about selecting SV No. by user key.

Setting the SV No. Max

The following steps explain how to set the SV No. Max by using SV4 as an example.

- 1 Press and hold the **SEL** key to display the setup mode channel menu ("oPE Ch 1"), then use the **▲** **▼** keys to display PLT ("PLT Ch 3").



Refer to See p. 46 in this chapter for information on how to display the channel menu.

- 2 Press and hold the **SEL** key to display the SV parameter ("Sv 1"), then use the **▲** **▼** keys to display SvMX ("SvMX").

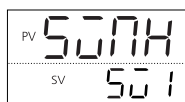

- 3 Press the **SEL** key, then use the **▲** **▼** keys to select Sv4 when the bottom part of the display begins to blink.

SV will cycle up to SV4.

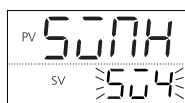

- 4 Press the **SEL** key to confirm the setting.

- 5 Press the **A/M** key to return to the operation mode PV/SV display.

Setting the Maximum PID Selection Number

The following sets the maximum number that can be switched to when switching the PID No. via the USER key.

- Range: PID0 to PID7, di

Refer to See "USER Key Assignments" (p.93) for more information about selecting PID No. by user key.

Setting the PID No. Max

The following steps explain how to set the PID No. Max by using PID6 as an example.

- 1 Press and hold the **SEL** key to display the setup mode channel menu ("oPE Ch 1"), then use the **▲** **▼** keys to display the palette menu ("PLT Ch 3").

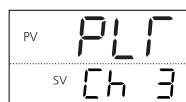

Refer to See p. 46 in this chapter for information on how to display the channel menu.

- 2 Press and hold the **SEL** key to display the SV parameter ("Sv 1"), then use the **▲** **▼** keys to display PL1M ("PL 1M").

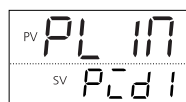

- 3 Press the **SEL** key, then use the **▲** **▼** keys to select Pid6 when the bottom part of the display begins to blink.

PID will now cycle up to PID6.

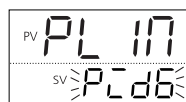

- 4 Press the **SEL** key to confirm the setting.

- 5 Press the **A/M** key to return to the operation mode PV/SV display.

MEMO

Chapter 6

Ramp/Soak Parameters (Ch4)

Overview of Ramp/Soak Parameters (Ch4) – 54

Ramp/Soak Activation Pattern – 56

Ramp/Soak Time Units – 57

Ramp/Soak SV Select (step1) to (step16),
Ramp Time (step1) to (step16),
Time Soak (step1) to (step16) – 58

Ramp/Soak Mode – 59

Guaranteed Soak, Guaranteed Soak Lower Limit, Guaranteed Soak Upper Limit – 60

PV start – 61

Continue mode – 61

Setting the Max Pattern Selection, Setting the Min Pattern Selection – 62

Overview of Ramp/Soak Parameters (Ch4)

This function automatically runs after setting SV and the times for the SV changes.

SV can be set to up to 16 steps using 6 different ramp/soak patterns.

- Ramp: Change SV to reach a target SV
- Soak: Maintain a set SV

The ramp/soak menu (ch4) consists of the following function blocks.

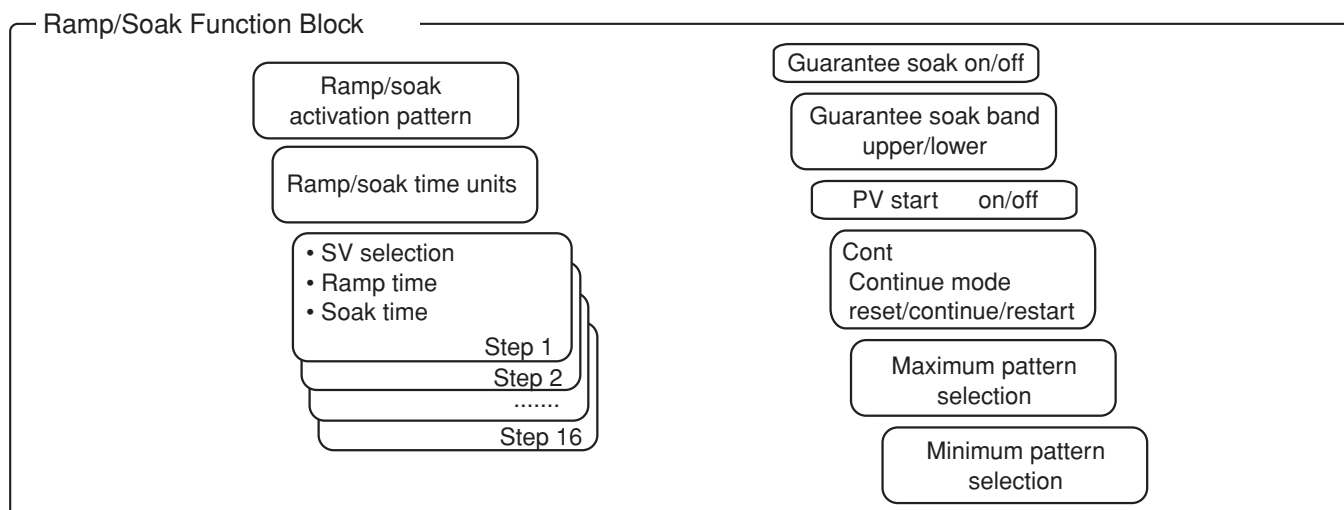

Display	Parameter name	Function	Setting range	Initial value	Remarks	Page
"Pr n"(PTn)	Ramp/Soak Activation Pattern	Sets which steps to execute in the ramp/soak operation pattern	0 (uses steps 1 to 4) 1 (uses steps 5 to 8) 2 (uses steps 1 to 8) 3 (uses steps 9 to 12) 4 (uses steps 13 to 16) 5 (uses steps 9 to 16) 6 (uses steps 1 to 16) di (according to DI)	6	(Note 3)	56
"TnU" (TiMU)	Ramp/soak time units	Sets the units used when setting the ramp/soak time	hh.MM (hour:min) MM.SS (min:sec)	hh.MM		57
"Sv- 1" (Sv-1)	Ramp/soak 1seg/SV Set Value	Sets the SV	0% to 100% FS	0%FS		58
"T1r" (TM1r)	Ramp/soak 1seg ramp time	Sets the ramp time	00:00 to 99:59 (hour:min/min:sec)	00:00 (hour:min)		
"T1S" (TM1S)	Ramp/soak 1 seg soak time	Sets the soak time	00:00 to 99:59 (hour:min/min:sec)	00:00 (hour:min)		
⋮	⋮	⋮	⋮	⋮	⋮	⋮
"Sv 16" (Sv16)	Ramp/soak 16seg/SV Set Value	Sets the SV	0% to 100% FS	0%FS		58
"T16r" (T16r)	Ramp/soak 16seg ramp time	Sets the ramp time	00:00 to 99:59 (hour:min/min:sec)	00:00 (hour:min)		
"T16S" (T16S)	Ramp/soak 16seg soak time	Sets the soak time	00:00 to 99:59 (hour:min/min:sec)	00:00 (hour:min)		

Display	Parameter name	Function	Setting range	Initial value	Remarks	Page
"Mod" (Mod)	Ramp/soak mode	Sets the program operation method	0 (P-ON: Off, End: Maintain, OFF: Maintain, Repeat: Off) 1 (P-ON: Off, End: Maintain, OFF: Maintain, Repeat: On) 2 (P-ON: Off, End: Maintain, OFF: Standby, Repeat: Off) 3 (P-ON: Off, End: Maintain, OFF: Standby, Repeat: On) 4 (P-ON: Off, END: Standby, OFF: Maintain, Repeat: Off) 5 (P-ON: Off, END: Standby, OFF: Maintain, Repeat: On) 6 (P-ON: Off, END: Standby, OFF: Standby, Repeat: Off) 7 (P-ON: Off, END: Standby, OFF: Standby, Repeat: On) 8 (P-ON: On, End: Maintain, OFF: Maintain, Repeat: Off) 9 (P-ON: On, End: Maintain, OFF: Maintain, Repeat: On) 10 (P-ON: On, End: Maintain, OFF: Standby, Repeat: Off) 11 (P-ON: On, End: Maintain, OFF: Standby, Repeat: On) 12 (P-ON: On, END: Standby, OFF: Maintain, Repeat: Off) 13 (P-ON: On, END: Standby, OFF: Maintain, Repeat: On) 14 (P-ON: On, END: Standby, OFF: Standby, Repeat: Off) 15 (P-ON: On, END: Standby, OFF: Standby, Repeat: On)	0	[RST]	59
"GSok" (GSok)	Guaranty soak ON/OFF	Sets the guaranty soak on or off.	oFF (guaranty soak off) on (guaranty soak on)	oFF		60
"GS-L" (GS-L)	Guaranty soak band (lower)	Sets the lower limit for the guaranty soak band	0% to 50% FS	5°C		60
"GS-h" (GS-h)	Guaranty soak band (upper)	Sets the upper limit for the guaranty soak band.	0% to 50% FS	5°C		
"PvST" (PvST)	PV start	Sets whether or not to start ramp soak with PV.	oFF (PV start off) on (PV start on)	oFF		61
"ConT" (ConT)	Continue mode	Sets how to restart when the controller is restored after a power loss during ramp soak.	rES (Reset) Con (Continue) ini (Restart)	rES	(Note 3)	61
"PTnM" (PTnM)	Sets the max pattern selection	Choosing pattern with the user key sets it to the maximum possible number.	0 to 6, di	6		62
"PMin" (PMin)	Pattern selection Min setting	Choosing pattern with the user key sets it to the minimum possible number.	0 to 6, di	0		62

Note 1: Turn off the power to the unit after changing the parameters with [RST] in the remarks column.

Note 2: The range of the parameters in the shaded area indicates the industrial values.

Note 3: Do not change this parameter during ramp/soak operations. Make sure that "P-ON" = "oFF" before making changes.

PrG Ramp/Soak Activation Pattern

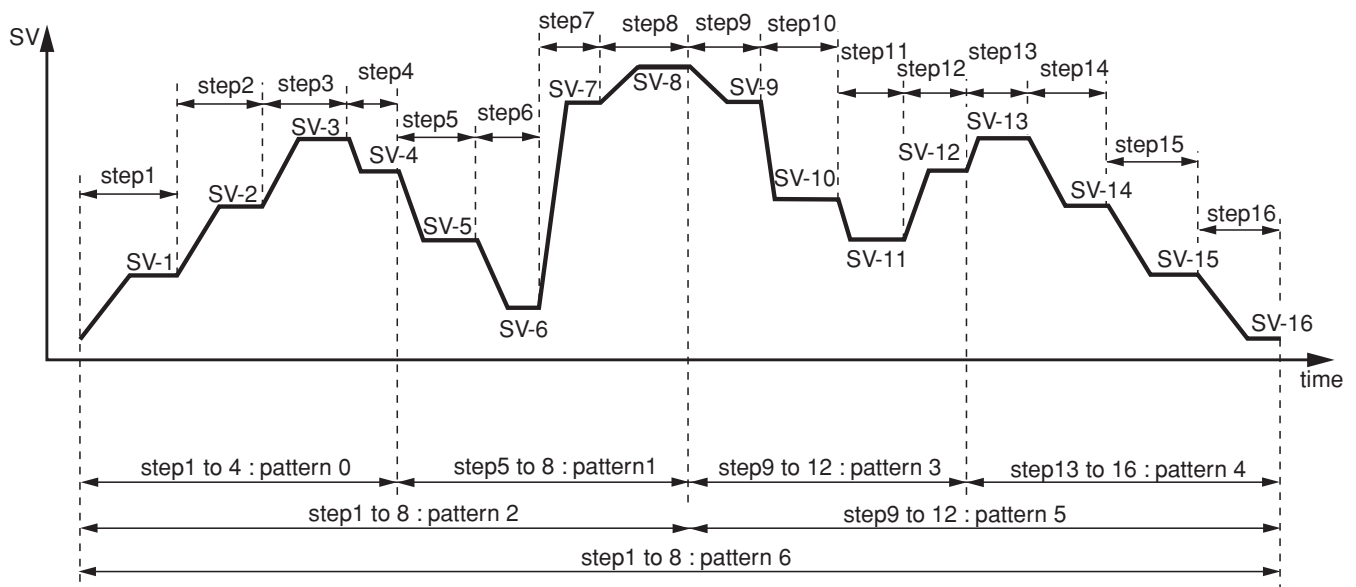

Chapter
6

The 16-step ramp/soak patterns are divided into seven types, any one of which can be used.

- Range 0: Steps 1 to 4
- 1: Steps 5 to 8
- 2: Steps 1 to 8
- 3: Steps 9 to 12
- 4: Steps 13 to 16
- 5: Steps 9 to 16
- 6: Steps 1 to 16

Caution

Do not change this parameter during ramp/soak operations. Make sure that "PrG" = "OFF" before making changes.

Setting the Ramp/Soak Activation Pattern

The following steps explain how to set the ramp/soak activation pattern by using steps 1-4 as an example.

Operation mode

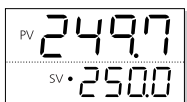

1 Press and hold the **SEL** key to display Mv1 ("Mv1").

The MV1 output of the monitoring mode is displayed.



2 Press and hold the **SEL** key to display the setup mode channel menu ("oPE Ch 1"), then use the **▲** **▼** keys to display PrG ("PLG Ch 4"). Set the ramp/soak menu.

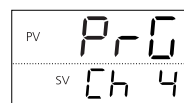

3 Press and hold the **SEL** key, then use the **▲** **▼** keys to display PTn ("Prn"). Select an activation pattern.

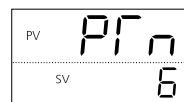

4 Press the **SEL** key, then use the **▲** **▼** keys to select 0 when the bottom part of the display begins to blink. Pattern 0 is selected.

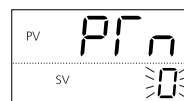

5 Press the **SEL** key to confirm the setting.

6 Press the **AM** key to return to the operation mode PV/SV display.

Ramp/Soak Time Units

The following sets the ramp/soak time units for ramp/soak activation.



Select one of the following:

- Range hh : MM(hour:min)
MM : SS(min:sec)

Point



Time units cannot be set separately for each step.
All steps use the same unit of time.

Setting Ramp/Soak SV, Ramp Time and Soak Time

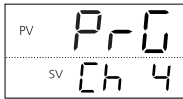

- 1** Press and hold the  key to display the setup mode channel menu ("oPE [h 1]), then use the   keys to display PrG ("PLF [h 4]).



See p. 56 in this chapter for information on how to display the operation menu.

- 2** Press and hold the  key, then use the   keys to display TIMU ("fLNU").
Select the ramp/soak time units.



- 3** Press the  key, then use the   keys to select "hh.MM" when the bottom part of the display begins to blink.
Ramp/soak time unit is set to "hr:min".



- 4** Press the  key to confirm the setting.

- 5** Press the  key to return to the operation mode PV/SV display.

SV-1 to SV-16 Ramp/Soak SV Select (step1) to (step16)
TM1r to TM16r Ramp Time (step1) to (step16)
TM1S to TM16S Time Soak (step1) to (step16)

The following sets ramp/soak SV, ramp time and soak time.
 The range for each is shown below.

SV	SV lower limit (SV) to SV upper limit (SVh) %FS
Ramp time	00:00 to 99:59 (hour:min/min:sec)
Soak time	00:00 to 99:59 (hour:min/min:sec)

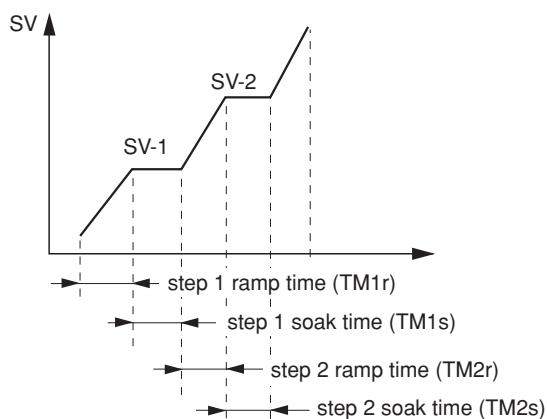

- Both ramp time and soak time skip segment 0.
- [Example]
- | | | |
|-------------|-------------|-------------|
| SV-1 : 50 | SV-2 : 200 | SV-3 : 100 |
| TM1r : 0.10 | TM2r : 0.00 | TM3r : 1.00 |
| TM1S : 0.05 | TM2S : 0.00 | TM3S : 0.75 |

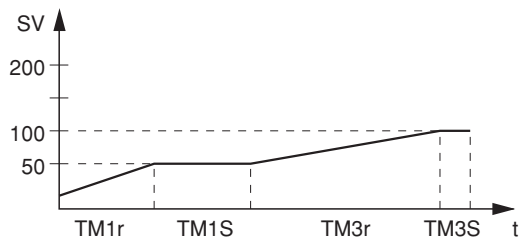

- The SV limit function (SV-h, SV-L) is still on while ramp/soak is running. The set value (SV-n) does not change, but the value is limited during ramp/soak. For that reason, the value may not change at the set times for the following patterns.

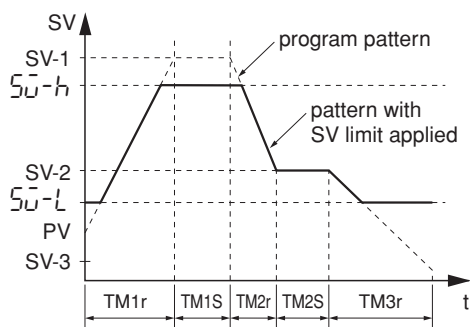

Setting Ramp/Soak SV, Ramp Time and Soak Time

- Press and hold the **SEL** key to display the setup mode channel menu ("oPE Ch 1"), then use the **▲** **▼** keys to display PrG ("PrG Ch 4").

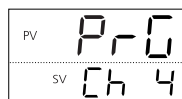

Refer to See p. 56 in this chapter for information on how to display the operation menu.

- Press and hold the **SEL** key, then use the **▲** **▼** keys to display Sv-1 ("SV- 1"). Set the goal for the step 1 SV value.

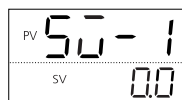

- Press the **SEL** key, then use the **▲** **▼** keys to select 200.0 when the bottom part of the display begins to blink. The value is set to 200.0°C.



- Press the **SEL** key to confirm the setting.

- Repeat steps 2-4 (excluding pressing and holding the **SEL** key) to specify the ramp and soak times. Repeat the necessary steps to set other variables.

- Press the **AM** key to return to the operation mode PV/SV display.

Mod Ramp/Soak Mode

The following sets the method of ramp/soak operation.

The following items can be set.

Power-on start	Starts ramp/soak from the current PV value when the equipment is turned on.
END time output	Maintains the same state as at the end of ramp/soak when ramp/soak is complete.
OFF time output	Switches to the OFF state when ramp/soak is complete.
Repeat operation	Repeats ramp/soak from step 1 when the last step finishes.

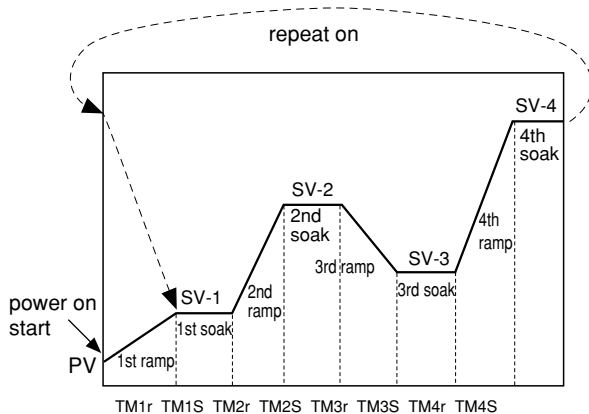

You can choose from the following 16 types of modes according to the combination of run method options.

MOD	Power On Start	Ending Output	OFF Output	Repeat Behavior
0	none	Maintain control	Maintain control	none
1	none	Maintain control	Maintain control	on
2	none	Maintain control	Standby Mode	none
3	none	Maintain control	Standby Mode	on
4	none	Standby Mode	Maintain control	none
5	none	Standby Mode	Maintain control	on
6	none	Standby Mode	Standby Mode	none
7	none	Standby Mode	Standby Mode	on
8	on	Maintain control	Maintain control	none
9	on	Maintain control	Maintain control	on
10	on	Maintain control	Standby Mode	none
11	on	Maintain control	Standby Mode	on
12	on	Standby Mode	Maintain control	none
13	on	Standby Mode	Maintain control	on
14	on	Standby Mode	Standby Mode	none
15	on	Standby Mode	Standby Mode	on

Point

When not in repeat operation, the last SV value is held when ramp/soak finishes.

Setting the Ramp/Soak Mode

- Press and hold the **SEL** key to display the setup mode channel menu ("oPE Ch 1"), then use the **▲** **▼** keys to display PrG ("PrG Ch 4").

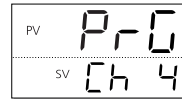

Refer to See p. 56 in this chapter for information on how to display the operation menu.

- Press and hold the **SEL** key, then use the **▲** **▼** keys to display Mod ("Mod"). Set the ramp/soak mode.

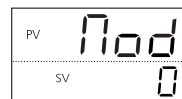

- Press the **SEL** key, then use the **▲** **▼** keys to select 1 when the bottom part of the display begins to blink. Ramp/soak is set to repeat.

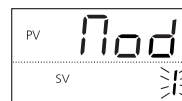

- Press the **SEL** key to confirm the setting.

- Press the **AIM** key to return to the operation mode PV/SV display.

GSok Guaranteed Soak

GS-L Guaranteed Soak Lower Limit

GS-H Guaranteed Soak Upper Limit

This function guarantees soak time. Soak time only counts down when SV is in the proper temperature range.

In the diagram below, the total of the shaded regions counts towards soak time. When this total matches the specified soak time, the cycle proceeds to the next step.

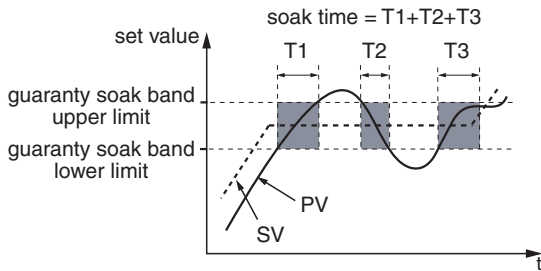

The following settings are available.

- Guaranty soak : Yes/No
- Guaranty soak upper limit : 0% to 50% FS
- Guaranty soak lower limit : 0% to 50% FS

Setting Guaranty Soak

The following steps explain how to set guaranty soak by using guaranty soak = "Yes" and a range of 5°C between the upper and lower limits as an example.

- 1 Press and hold the **SEL** key to display the setup mode channel menu ("oPE Ch 1"), then use the **▲** **▼** keys to display PrG ("PrG Ch 4").

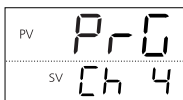

Refer to See p. 56 in this chapter for information on how to display the operation menu.

- 2 Press and hold the **SEL** key, then use the **▲** **▼** keys to display GSok ("GSok"). Select an activation pattern.

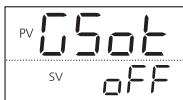

- 3 Press the **SEL** key, then use the **▲** **▼** keys to select "on" when the bottom part of the display begins to blink.

Guaranty soak is set.

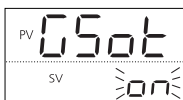

- 4 Press the **SEL** key to confirm the setting.

- 5 Use the **▲** **▼** keys to display GS-L ("GS-L"). Set the guaranty soak lower limit.

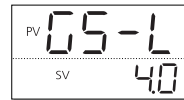

- 6 Press the **SEL** key, then use the **▲** **▼** keys to set 5.0 when the bottom part of the display begins to blink.

The guaranty soak lower limit is set to 5.0°C.



- 7 Repeat steps 5 and 6 to set the guaranty soak upper limit GS-H ("GS-H").

- 8 Press the **A/M** key to return to the operation mode PV/SV display.

PvSt PV start

When the ramp soak starts (RUN), this function searches the first point where the measurement value (PV) and the program pattern match, and starts operation at that point.

If the measurement value does not match the pattern as with ③, the normal operation starts.

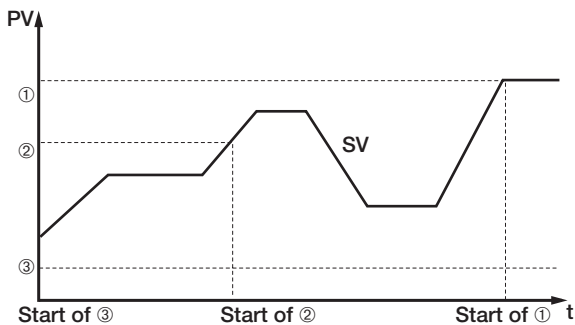

Setting range

- on : PV start on
- oFF : PV start off

Setting PV Start

This section explains how to enable PV start.

- 1 Press and hold the **SEL** key to display the setup mode channel menu ("oPE Ch 1"), then use the **▲** **▼** keys to display PrG ("PrG Ch 4").

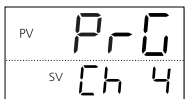

Refer to See p. 56 in this chapter for information on how to display the operation menu.

- 2 Press and hold the **SEL** key, and use the **▲** **▼** keys to display PvSt ("PvSt").

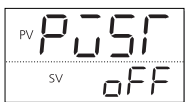

- 3 Press the **SEL** key, then use the **▲** **▼** keys to set PV start to "on" when the bottom part of the display begins to blink. PV start is set to "on".

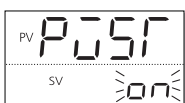

- 4 Press the **AM** key to return to the operation mode PV/SV display.

ConT Continue mode

"When the power of the PXG turns off during operation due to power outage or other reasons, this function can specify the ramp soak operation when the PXG turns on again.

(The PXG returns to the state up to five minutes before.)

Setting range

- rES : Does not operate ramp soak.
- Con : Continues operation at the point where the power turned off.
- ini : Resumes ramp soak from the first step.

Caution Do not change this parameter during ramp/soak operations. Make sure that "PrG" = "oFF" before making changes.

Setting the Continue Mode

The following steps explain how to set the Restore mode by using the continuous operation mode setting procedure as an example.

- 1 Press and hold the **SEL** key to display the setup mode channel menu ("oPE Ch 1"), then use the **▲** **▼** keys to display PrG ("PrG Ch 4").

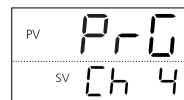

Refer to See p. 56 in this chapter for information on how to display the operation menu.

- 2 Press and hold the **SEL** key, and use the **▲** **▼** keys to display ConT ("ConT").

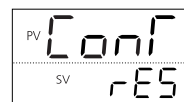

- 3 Press the **SEL** key, then use the **▲** **▼** keys to set SV to "Con" when the bottom part of the display begins to blink.

The continuous operation mode is set.



- 4 Press the **AM** key to return to the operation mode PV/SV display.

PrG Setting the Max Pattern Selection

PnLn Setting the Min Pattern Selection

Pressing the **USER** key sets the maximum number or the minimum number of patterns when sending a ramp/soak pattern.

- Range: 0 to 6



- See "Ramp/Soak Activation Patterns" for more information on ramp/soak patterns. (p. 56)
- See "USER Key Assignments" for more about setting the USER key (p. 93).

Caution

Do not set a value for Min pattern selection that is higher than the value for Max pattern selection.

Selecting a Maximum/Minimum Number of Patterns

The following steps explain how to set the minimum number of patterns to "2" and the maximum number of patterns to "4" as an example.

- 1 Press and hold the **SEL** key to display the setup mode channel menu ("oPE Ch 1"), then use the **▲** **▼** keys to display PrG ("PrG Ch 4").



See p. 56 in this chapter for information on how to display the operation menu.

- 2 Press and hold the **SEL** key, then use the **▲** **▼** keys to display PTnM ("PrnM").
Select an activation pattern.



- 3 Press the **SEL** key, then use the **▲** **▼** keys to select 4 when the bottom part of the display begins to blink.
The maximum number of patterns selectable is set to 4.



- 4 Press the **SEL** key to confirm the setting.

- 5 Use the **▲** **▼** keys to display PMin ("PnLn").
Select an activation pattern.



- 6 Press the **SEL** key, then use the **▲** **▼** keys to select 2 when the bottom part of the display begins to blink.

The maximum number of patterns selectable is set to 2.

Two patterns can now be selectable.

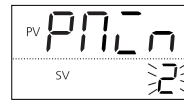

- 7 Press the **SEL** key to confirm the setting.

- 8 Press the **AIM** key to return to the operation mode PV/SV display.

Chapter 7

Monitor Parameters (Ch5)

Overview of Monitor Parameters (Ch5) – 64

Ramp/Soak Operation Display – 65

Control Output Display – 65

PFB Input Value Display – 66

Remote SV (RSV) Input Display – 66

Heater Current Display – 67

Leak Current Display – 67

Remaining Time on Timer – 68

Error Source Display – 68

Current palette No. – 69

Current pattern No. – 69

Overview of Monitor Parameters (Ch5)

The monitor allows you to verify the current input and output conditions of the controller.

The monitor can display the following items.

These parameters are displayed only. The settings cannot be changed in these parameters.

Display	Parameter name	Function	range	Remarks	Page
"STAT" (STAT)	Ramp/soak progress	Displays the progress of the ramp/soak	oFF (ramp/soak is stopped) 1-rP (Step 1 Ramp) 1-Sk (Step 1 Soak) ⋮ 16rP (Step 16 Ramp) 16Sk (Step 16 Soak) End (ramp/soak is finished)		65
"MV1" (MV1)	Control Output Display (MV1)	Displays the output value of the control output (OUT1).	-3.0% to 103.0%		65
"MV2" (MV2)	Control Output Display (MV2)	Displays the output value of the control output (OUT2) (during dual control).	-3.0% to 103.0%	Note 1	
"PFb" (PFb)	PFB Input Value Display	Displays the input value of the position feedback	-3.0% to 103.0%	Note 2	66
"rSv" (rSv)	RSV Input Value Display	Displays the input value for RSV.	-5% to 105% FS	Note 3	66
"CT1" (CT1)	Heater current	Displays the heater current	0A, 0.4A to 50.0A	Note 4	67
"LC1" (LC1)	Leak current	Displays the leak current	0A, 0.4A to 50.0A	Note 4	67
"TM1" (TM1)	Remaining time on timer 1	Displays the remaining time on timer 1	0 sec to 9999 sec / 0 min to 9999 min	Note 5	68
"TM2" (TM2)	Remaining time on timer 2	Displays the remaining time on timer 2	0 sec to 9999 sec / 0 min to 9999 min	Note 5	
"TM3" (TM3)	Remaining time on timer 3	Displays the remaining time on timer 3	0 sec to 9999 sec / 0 min to 9999 min	Note 5	
"TM4" (TM4)	Remaining time on timer 4	Displays the remaining time on timer 4	0 sec to 9999 sec / 0 min to 9999 min	Note 5	
"TM5" (TM5)	Remaining time on timer 5	Displays the remaining time on timer 5	0 sec to 9999 sec / 0 min to 9999 min	Note 5	
"FALT" (FALT)	Error source display	Displays the source of an error			68
"PLno" (PLno)	Current palette No.	Displays the PID palette No. currently selected.	0 to 7		69
"PTno" (PTno)	Current pattern No.	Displays the pattern No. of the ramp soak currently selected.	0 to 6		69

Note 1: Displays when the sixth digit is A, C, E, or P. (Standard type only).

Note 2: Displays when the fifth digit of the model number is V.

Note 3: Displays when the seventh number of the model number is H, K, E, or 2, or the eleventh digit is D (RSV included).

Note 4: Displays when the seventh number of the model number is G or J, or the eleventh digit is A (CT included).

Note 5: Displays depending on the ninth digit and eleventh digit of the model code.

Note 6: The parameters in the shaded area indicates the industrial values.

SRAR Ramp/Soak Operation Display

The current state of the ramp/soak can be shown on the display.

The following conditions are possible:

Display	Condition
"OFF"	Ramp/soak is stopped
"1-rP"	Step 1 ramp
"1-SL"	Step 1 soak
"2-rP"	Step 2 ramp
"2-SL"	Step 2 soak
⋮	⋮
"16-rP"	Step 16 ramp
"16-SL"	Step 16 soak
"End"	Ramp/soak is finished

Refer to  For details on ramp/soak, refer to "Chapter 6, Ramp/Soak Parameters" (p. 53)

Checking the State of Ramp/Soak

Operation mode

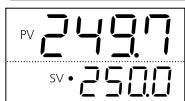

- 1 Press and hold the **SEL** key to display "M01".
The MV1 of the monitoring mode will appear.

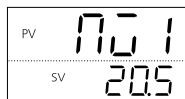

- 2 Press and hold the **SEL** key to display the setup mode channel menu ("OP Ch 1") and use the **▲** **▼** keys to display Mon ("Mon Ch 5").
The monitor menu will appear.



- 3 Press and hold the **SEL** key, then use the **▲** **▼** keys to display STAT ("SRAR").
Confirm the state of the ramp/soak.

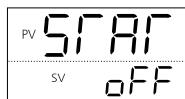

- 4 Press the **AM** key to return to the operation mode PV/SV display.





Control Output Display

The current output values of OUT1 and OUT2 can be shown on the display.

Checking the Control Output Display

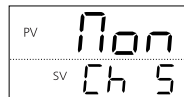
- 1 Press and hold the **SEL** key to display the setup mode channel menu ("OP Ch 1") and use the **▲** **▼** keys to display Mon ("Mon Ch 5").



Refer to  See this page for information on how to display the channel menu.

- 2 Press and hold the **SEL** key, then use the **▲** **▼** keys to display Mv1 ("M01").
Confirm the control output of OUT1.

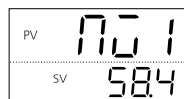

- 3 Repeat step 2 (excluding pressing and holding the **SEL** key) to display Mv2 ("M02").

- 4 Press the **AM** key to return to the operation mode PV/SV display.

Pfb

PFB Input Value Display

Motorized valve opening will be displayed when using position feedback (PFB) as the control.



For details on PFB, refer to "Chapter 12, Position Feedback Parameters (PFB, Ch10)" (p. 125).

Checking the PFB Input Value Display

- 1 Press and hold the key to display the setup mode channel menu ("oPE Ch 1") and use the keys to display Mon ("non Ch 5").



See p. 65 in this chapter for information on how to display the channel menu.

- 2 Press and hold the key, then use the keys to display Pfb ("Pfb"). Confirm the motorized valve opening.

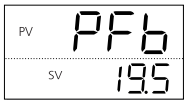

- 3 Press the key to return to the operation mode PV/SV display.

rSv

Remote SV (RSV) Input Display

Displays the remote SV input value.

Checking the Remote SV Input Value

- 1 Press and hold the key to display the setup mode channel menu ("oPE Ch 1") and use the keys to display Mon ("non Ch 5").



See p. 65 in this chapter for information on how to display the channel menu.

- 2 Press and hold the key, then use the keys to display rSv ("rSv"). Checks the remote SV input value.

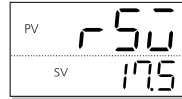

- 3 Press the key to return to the operation mode PV/SV display.

CT1 Heater Current Display

Display the Heater current value.

Refer to For details on heater break alarms, refer to "HB Alarm Set Value, Hysteresis" (p. 114).

Caution Values for current below 0.4 A are cut off and displayed as 0.0 A.

Checking the value for Heater current

- 1 Press and hold the **SEL** key to display the setup mode channel menu ("oPE Ch 1") and use the **▲** **▼** keys to display Mon ("Mon Ch 5").

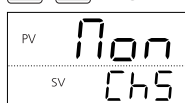

Refer to See p. 65 in this chapter for information on how to display the channel menu.

- 2 Press and hold the **SEL** key, then use the **▲** **▼** keys to display CT1 ("CT 1").

Confirm the heater current value.

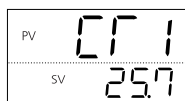

- 3 Press the **AM** key to return to the operation mode PV/SV display.

LC1 Leak Current Display

Display the Leak current value.

Refer to For details on heater alarms, refer to "Load short circuit alarm setting, Load short circuit alarm hysteresis."(p116)

Caution Values for current below 0.4 A are cut off and displayed as 0.0 A.

Checking the value for Leak current

- 1 Press and hold the **SEL** key to display the setup mode channel menu ("oPE Ch 1") and use the **▲** **▼** keys to display Mon ("Mon Ch 5").

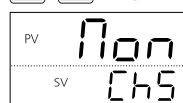

- 2 Press and hold the **SEL** key, then use the **▲** **▼** keys to display LC1 ("LC 1").

Confirm the leak current value.

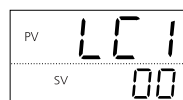

- 3 Press the **AM** key to return to the operation mode PV/SV display.

TM1 to TM5

Remaining Time on Timer

Displays the remaining time on the timer.

Refer to For more on alarm delay, refer to "Alarm Hysteresis, Delay Time, Delay Time Units" (p. 113).

Checking the Time Remaining on Timer

- 1** Press and hold the **SEL** key to display the setup mode channel menu ("oPE Ch 1") and use the **▲** **▼** keys to display Mon ("Mon Ch 5").

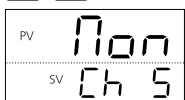

Refer to See p. 65 in this chapter for information on how to display the channel menu.

- 2** Press and hold the **SEL** key, then use the **▲** **▼** keys to display TM1 ("TM 1").

Confirm the time remaining on timer 1.

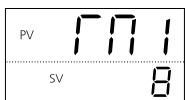

- 3** Repeat step 2 (excluding pressing and holding the **SEL** key) to confirm TM2 to TM5 ("TM2" to "TM5").

- 4** Press the **AIM** key to return to the operation mode PV/SV display.

FALT Error Source Display

Displays the source of an error.

Checking the Error Source

- 1** Press and hold the **SEL** key to display the setup mode channel menu ("oPE Ch 1") and use the **▲** **▼** keys to display Mon ("Mon Ch 5").

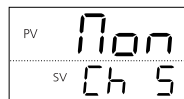

Refer to See p. 65 in this chapter for information on how to display the channel menu.

- 2** Press and hold the **SEL** key, then the **▲** **▼** keys to display FALT ("FALT").

Confirm the source of the error.

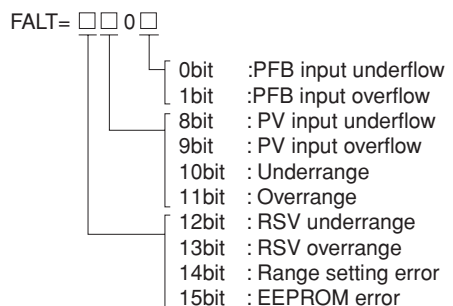

- 3** Press the **AIM** key to return to the operation mode PV/SV display.

PLno Current palette No.

Displays the PID palette No. currently selected.

Checking the Palette No.

- 1 Press and hold the **SEL** key to display the setup mode channel menu ("oPE Ch 1") and use the **▲** **▼** keys to display Mon ("Mon Ch 5").



Refer to See p. 65 in this chapter for information on how to display the channel menu.

- 2 Press and hold the **SEL** key, then use the **▲** **▼** keys to display Plno ("PLno"). Check the palette No. currently selected.



- 3 Press the **AM** key to return to the operation mode PV/SV display.

Prno Current pattern No.

Displays the ramp soak pattern No. currently selected.

Checking the Pattern No.

- 1 Press and hold the **SEL** key to display the setup mode channel menu ("oPE Ch 1") and use the **▲** **▼** keys to display Mon ("Mon Ch 5").

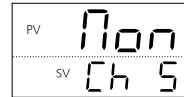

Refer to See p. 65 in this chapter for information on how to display the channel menu.

- 2 Press and hold the **SEL** key, then use the **▲** **▼** keys to display Plno ("PLno"). Check the pattern No. currently selected.

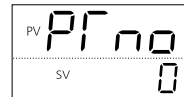

- 3 Press the **AM** key to return to the operation mode PV/SV display.

MEMO

Chapter 8

Setup Parameters (Ch6)

Overview of Setup Parameters (Ch6) – 72
PV Input Types – 74
PV Input Lower Limit, PV Input Upper Limit – 75
Decimal Place – 75
PV Input Shift – 76
SV Offset – 76
PV Input Filter – 77
PV Display Zero Adjustment, PV Display Span Adjustment – 78
Cold Junction Compensation – 79
Remote SV Zero Adjustment, Remote SV Span Adjustment – 80
Remote SV Input Range – 81
Remote SV Input Filter – 82
OUT1 Range, OUT2 Range – 83
FALT OUT1 Value, FALT OUT2 Value – 83
Soft Start OUT1 Output, Soft Start Time – 84
Standby OUT1 Output, Standby OUT2 Output – 85
Standby Mode Settings – 85
AO Output Type – 86
AO Lower Limit Scaling, AO Upper Limit Scaling – 87

Overview of Setup Parameters (Ch6)

This section covers the analog input and output of this device.

This section applies to the following types of input:

- PV(Input from sensors such as thermocouples and resistance thermometer bulbs)
- RSV(Remote SV input)
- OUT1/OUT2 (Current/Voltage control output)
- AO (Re-transmission Output)

Display	Parameter name	Function	Setting range	Initial value	Remarks	Reference Page
"P _{UV} " (PvT)	PV input type	Sets the type of input sensor	0 (JPT 100Ω) 1 (PT 100Ω) 2 (J) 3 (K) 4 (R) 5 (B) 6 (S) 7 (T) 8 (E) 9 (no function) 10 (no function) 11 (no function) 12 (N) 13 (PL- II) 14 (no function) 15 (0V to 5V/0mA to 20mA) 16 (1V to 5V/4mA to 20mA) 17 (0mV to 10V) 18 (2V to 10V) 19 (0mV to 100mV)	3 (K)	RST	74
"P _{Ub} " (Pvb)	PV input lower limit	Sets a lower limit for PV input	-1999% to 9999%	0%	RST	75
"P _{UF} " (PvF)	PV input upper limit	Sets the upper limit for PV input	-1999% to 9999%	400°C	RST	75
"P _{Ud} " (Pvd)	Decimal position	Sets the position of the decimal point for PV/SV display	0 (no decimal point) 1 (one decimal place) 2 (two decimal places)	0	RST	75
"P _{Uu} " (PvU)	Unit display	This is the procedure for specifying the units of the PV/SV display.	°C/°F	°C		—
"P _{UoF} " (PvoF)	PV input shift	Sets the amount of shift for PV input	0% to 100% FS	0%		76
"S _{UoF} " (SVoF)	SV offset	Sets the amount of shift in SV	-50% to 50% FS	0%		76
"FF" (TF)	PV input filter	Sets the time constant for the PV input filter	0.0 sec to 120.0 sec	5.0sec		77
"R _{dJ0} " (AdJ0)	PV display Zero adjustment	Adjusts the zero side in the PV display	-50% to 50% FS	0%		78
"R _{dJ5} " (AdJS)	PV display Span adjustment	Adjusts the span side in the PV display	-50% to 50% FS	0%		78
"r _{CJ} " (rCJ)	Cold Junction Compensation	Sets whether cold junction compensation is performed	oFF (Off)/on (On)	on		79
"r _{EM0} " (rEMO)	RSV Zero adjustment	Adjusts zero side in RSV input	-50% to 50% FS	0%	Note 1	80
"r _{EM5} " (rEMS)	RSV Span adjustment	Adjusts the span side of RSV input	-50% to 50% FS	0%	Note 1	80
"r _{EMr} " (rEMr)	RSV Input Range	Specifies the RSV input range	0-5 (0mA to 5V) 1-5 (1V to 5V)	1-5v	Note 1	81
"r _{FF} " (rTF)	RSV Input Filter	Sets the time constant for the RSV input filter	0.0 sec to 120.0 sec	0.0 sec	Note 1	82
"C _{1r} " (C1r)	OUT1 range	Sets the range of the control output (OUT2)	0-5 (0mA to 5V) 1-5 (1V to 5V) 0-10 (0mA to 10V) 2-10 (2V to 10V) 0-20 (0mA to 20mA) 4-20 (4mA to 20mA)	0-10 (Voltage) 4-20 (Current)	Note 2 Note 3	83

Display	Parameter name	Function	Setting range	Initial value	Remarks	Reference Page																																				
"C2r" (C2r)	OUT2 range	Sets the range of the control output (OUT2)(Sets also for re-transmission output)	0-5 (0mA to 5V) 1-5 (1V to 5V) 0-10 (0mA to 10V) 2-10 (2V to 10V) 0-20 (0mA to 20mA) 4-20 (4mA to 20mA)	0-10 (Voltage) 4-20 (Current)	Note 3 Note 4 Note 5	83																																				
"FLo1" (FLo1)	Output 1 set value during FALT	Sets the output value for the control output (OUT1) during FALT	-3.0% to 103.0%	-3.0%		83																																				
"FLo2" (FLo2)	Output 2 set value during FALT	Sets the output value for the control output (OUT2) during FALT	-3.0% to 103.0%	-3.0%	Note 6																																					
"SFo1" (SFo1)	Soft start OUT1 set value	Sets the output value for the control output (OUT1) during soft start	-3.0% to 103.0%	103.0%		84																																				
"SFTM" (SFTM)	Soft Start detection time	Sets the time from power-on to soft start completion	00:00 to 99:59 (hour:min)	0.00 (hour:min)	Note 7																																					
"Sbo1" (Sbo1)	OUT1 set value during standby	Sets the output value for the control output (OUT1) during standby	-3.0% to 103.0%	-3.0%		85																																				
"Sbo2" (Sbo2)	OUT2 set value during standby	Sets the output value for the control output (OUT2) during standby	-3.0% to 103.0%	-3.0%	Note 6																																					
"SbMd" (SbMd)	Standby mode setting	Sets the alarm output, PV/SV display in standby mode.	<table border="1"> <thead> <tr> <th></th> <th>ALM Display/ Output</th> <th>Ao</th> <th>PV/SV Display</th> </tr> </thead> <tbody> <tr> <td>0</td> <td>OFF</td> <td>ON</td> <td>ON</td> </tr> <tr> <td>1</td> <td>ON</td> <td>ON</td> <td>ON</td> </tr> <tr> <td>2</td> <td>OFF</td> <td>OFF</td> <td>ON</td> </tr> <tr> <td>3</td> <td>ON</td> <td>OFF</td> <td>ON</td> </tr> <tr> <td>4</td> <td>OFF</td> <td>ON</td> <td>OFF</td> </tr> <tr> <td>5</td> <td>ON</td> <td>ON</td> <td>OFF</td> </tr> <tr> <td>6</td> <td>OFF</td> <td>OFF</td> <td>OFF</td> </tr> <tr> <td>7</td> <td>ON</td> <td>OFF</td> <td>OFF</td> </tr> </tbody> </table>		ALM Display/ Output	Ao	PV/SV Display	0	OFF	ON	ON	1	ON	ON	ON	2	OFF	OFF	ON	3	ON	OFF	ON	4	OFF	ON	OFF	5	ON	ON	OFF	6	OFF	OFF	OFF	7	ON	OFF	OFF	0	RST Note 8	85
	ALM Display/ Output	Ao	PV/SV Display																																							
0	OFF	ON	ON																																							
1	ON	ON	ON																																							
2	OFF	OFF	ON																																							
3	ON	OFF	ON																																							
4	OFF	ON	OFF																																							
5	ON	ON	OFF																																							
6	OFF	OFF	OFF																																							
7	ON	OFF	OFF																																							
"RoT" (AoT)	Types of AO output	Specify the re-transmission input type.	PV SV MV DV	Pv	Note 4	86																																				
"RoL" (AoL)	AO lower limit scaling		-100% to 100% FS	0%	Note 4	87																																				
"RoH" (Aoh)	AO upper limit scaling		-100% to 100% FS	100%	Note 4																																					

Note 1: Displays when the seventh digit is H, K, F, 2, or E, and the eleventh digit is D.

Note 2: Displays when the fifth digit of the model code is E or P.

Note 3: Select a setting range that fits the output type.

Note 4: Displays when the sixth digit of the model code is R or S.

Note 5: Displays when the sixth digit of the model code is E or P.

Note 6: Displays when the fifth digit of the model code is not S or V, and the sixth digit is A, C, E, or P.

Note 7: Make sure to set "0:00" during dual control.

Note 8: Turn off the power to the unit after changing the parameters with **RST** in the remarks column.

Note 9: The range of the parameters in the shaded area indicates the initial values.

PVF PV Input Types

PV input source can be any of the following, including thermocouples and resistance thermometer bulbs.

Setting	Input Type	Sensor Type
0	JPT 100Ω	Resistance thermometer bulb
1	PT100Ω	↓
2	J	Thermocouple
3	K	
4	R	
5	B	
6	S	
7	T	
8	E	
9	No function	⋮
10	No function	⋮
11	No function	⋮
12	N	
13	PL-II	
14	Reserved	↓
15	0V to 5V/0-20mA	Voltage/Current Input
16	1V to 5V/4-20mA	↓
17	0V to 10V	Voltage Input
18	2V to 10V	
19	0mA to 100mV	↓

Caution

- When changing between current input (0-20mA/4-20mA) and voltage input (0-5V/1-5V), remove the 250Ω resistor connected to the terminal block. (Or vice versa.)
- Different types of input (thermocouple/resistance thermometer bulb/voltage or current input) require different connections to the terminal block. Check the "Instruction Manual".

Setting the PV Input Type

This section explains how to change the PV input type with the example of changing from the factory thermocouple setting of K to R.

Operation mode

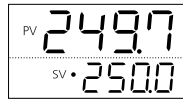

- 1 Press and hold the **SEL** key to display "nU l".
The MV1 of the monitoring mode is displayed.

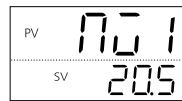

- 2 Press and hold the **SEL** key to display the setup mode channel menu ("oPE Ch l"), then use the **▲** **▼** keys to display SET ("SEr Ch 6").
Specify the PV input type.

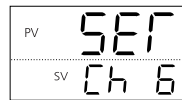

- 3 Press and hold the **SEL** key, then use the **▲** **▼** keys to display PvT ("PvT").

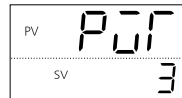

- 4 Press the **SEL** key, then use the **▲** **▼** keys to select 4 when the bottom part of the display begins to blink.

The PV input type is "R thermocouple".

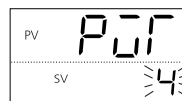

- 5 Press the **SEL** key to confirm the setting.

- 6 Press the **AIM** key to return to the operation mode PV/SV display.

P_{LB} PV Input Lower Limit

P_{UF} PV Input Upper Limit

This is the procedure for specifying the upper and lower limits of PV input. PV input can be set to any value within these bounds.

- Range: -1999% to 9999%

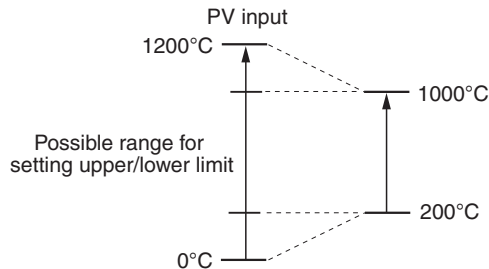

Setting PV Input Upper/Lower Limits

The following steps explain how to set PV input limits by using an upper limit of 1000°C and a lower limit of 200°C as an example.

- 1 Press and hold the **SEL** key to display the setup mode channel menu ("oPE [h l]"), then use the **▲** **▼** keys to display SET ("SEf [h 6]").



Refer to See p. 74 in this chapter for information on how to display the operation menu.

- 2 Press and hold the **SEL** key, then use the **▲** **▼** keys to display P_{LB} ("P_{LB}").

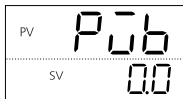

- 3 Press the **SEL** key, then use the **▲** **▼** keys to select 200.0 when the bottom part of the display begins to blink.

The PV input lower limit is set to 200°C.



- 4 Press the **SEL** key to confirm the setting.

- 5 Repeat steps 2-4 (excluding pressing and holding the **SEL** key) to set the PV input upper limit P_{UF} ("P_{UF}") to 1000°C.

- 6 Press the **AM** key to return to the operation mode PV/SV display.

Caution The value for each sensor can be set to exceed the possible measurement range, but accuracy is not guaranteed in these cases.

P_{UD} Decimal Place

This is the procedure for setting the decimal place in the PV display.

- Range 0: No decimal place
1: One decimal place
2: Two decimal places

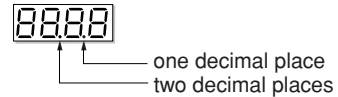

- Point**
- Two decimal places are available only when the input is voltage/current.
 - When using one decimal place display for temperature input, the decimal place will not be displayed for temperatures of 1000°C and over.

Setting the Decimal Place

The following steps explain how to set the decimal place by using one decimal place as an example.

- 1 Press and hold the **SEL** key to display the setup mode channel menu ("oPE [h l]"), then use the **▲** **▼** keys to display SET ("SEf [h 6]").

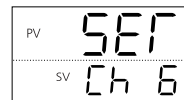

Refer to See p. 74 in this chapter for information on how to display the operation menu.

- 2 Press and hold the **SEL** key, then use the **▲** **▼** keys to display P_{UD} ("P_{UD}").

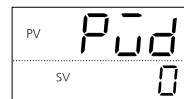

- 3 Press the **SEL** key, then use the **▲** **▼** keys to select 1 when the bottom part of the display begins to blink.

The decimal place is now set to one decimal place.

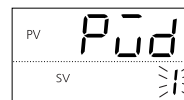

- 4 Press the **SEL** key to confirm the setting.

- 5 Press the **AM** key to return to the operation mode PV/SV display.

Pvof PV Input Shift

This function shifts PV input before display.

This is used when combining PV input with other instruments.

- Range: -10% to 10% FS

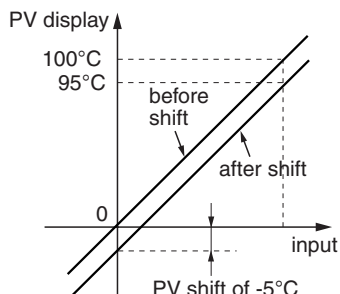

Setting PV Input Shift

- 1 Press and hold the **SEL** key to display the setup mode channel menu ("oPE Ch 1"), then use the **▲** **▼** keys to display SET ("SEf Ch 6").



Refer to See p. 74 in this chapter for information on how to display the operation menu.

- 2 Press and hold the **SEL** key, then use the **▲** **▼** keys to display PvoF ("Pvof").

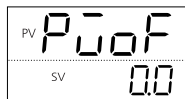

- 3 Press the **SEL** key, then use the **▲** **▼** keys to select -5.0 when the bottom part of the display begins to blink.

PV input shift is set to -5.0°C.

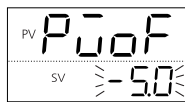

- 4 Press the **SEL** key to confirm the setting.

- 5 Press the **A/M** key to return to the operation mode PV/SV display.

Svof SV Offset

This function specifies the SV shift.

This is used to eliminate remaining offset when using P control.

- Controls act on the calculated SV with SV offset.
- Alarm determination acts on the displayed SV without SV offset.
- Range: -50% to 50%

Setting SV Shift

The following steps explain how to set SV shift by using 7°C as an example.

- 1 Press and hold the **SEL** key to display the setup mode channel menu ("oPE Ch 1"), then use the **▲** **▼** keys to display SET ("SEf Ch 6").

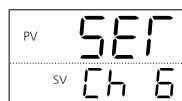

Refer to See p. 74 in this chapter for information on how to display the operation menu.

- 2 Press and hold the **SEL** key, then use the **▲** **▼** keys to display Svof ("Svof").

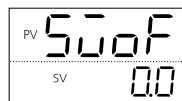

- 3 Press the **SEL** key, then use the **▲** **▼** keys to select 7.0 when the bottom part of the display begins to blink.

SV offset is set to 7.0°C.

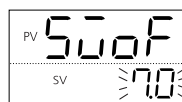

- 4 Press the **SEL** key to confirm the setting.

- 5 Press the **A/M** key to return to the operation mode PV/SV display.

Caution

The SV value in the PV/SV display shows the set value before the SV offset is added.

FF PV Input Filter

This low-pass filter function reduces noise and signal wavering.

- Range: 0.0 sec to 120.0 sec (input filter damping)

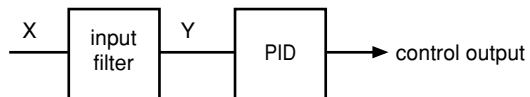

When the input suddenly steps from 0% to 100% with the input filter constant set to 5 seconds, the PV display will change slowly and take 5 seconds to change from 0% to 63.2%.

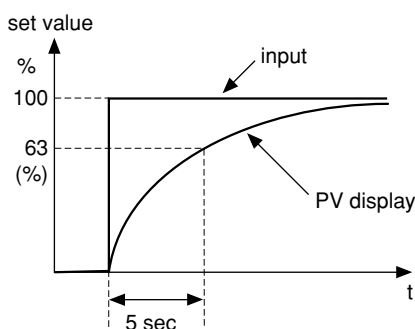

Caution

The factory setting for input filter damping is 5%. Do not change this unless absolutely necessary.

Setting the PV Input Filter

The following steps explain how to set the PV input filter by using 10 sec as an example.

- 1 Press and hold the **SEL** key to display the setup mode channel menu ("oPE Ch 1"), then use the **▲** **▼** keys to display SET ("SEt Ch 6").

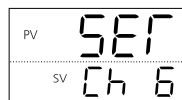

Refer to See p. 74 in this chapter for information on how to display the operation menu.

- 2 Press and hold the **SEL** key, then use the **▲** **▼** keys to display TF ("TF").

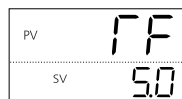

- 3 Press the **SEL** key, then use the **▲** **▼** keys to select 10.0 when the bottom part of the display begins to blink.

The PV input filter is set to 10.0.

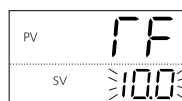

- 4 Press the **SEL** key to confirm the setting.

- 5 Press the **A/M** key to return to the operation mode PV/SV display.

Adj0 PV Display Zero Adjustment

Adj5 PV Display Span Adjustment

This is the procedure for adjusting the PV display zero/span. Set the following equipment before using these parameters or starting revisions.

- mv Generator
 - 1V to 5V (for voltage/current input)
 - 0mV to 100mV (for thermocouple input)
- Dial resistance unit
 - 100.0 to 400.0Ω (for resistance thermometer bulb input)
- Range: -50.0% to 50.0% FS(zero/span)

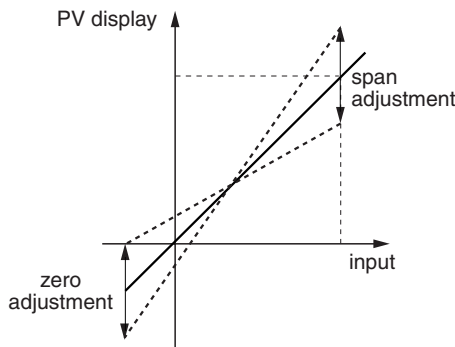

Point

- Set the zero/span adjustment value to "0" to restore the factory setting.
- The user correction function operates independently from the controller adjustment value. Setting this value to 0 returns the settings to the factory settings.

Setting PV Display Zero/Span

The following steps explain how to set PV zero/span adjustment by using zero display = -3°C and span display = 4°C as an example.

- 1** Confirm the accuracy of the PV by checking the PV values when the mV generator or dial resistor is at from 0 and 100%.

This example assumes a zero deviation of -3°C and a span deviation of 4°C.

Point

Before using thermocouple input, confirm that cold junction compensation is off. See "Cold Junction Compensation" (p. 79) for more information on changing these settings.

- 2** Press and hold the **SEL** key to display the setup mode channel menu ("oPE Ch 1"), then use the **▲** **▼** keys to display SET ("SEF Ch 6").

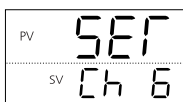

Refer to See p. 74 in this chapter for information on how to display the operation menu.

- 3** Set the input from the mV generator or dial resistor to 0%.

- 4** Press and hold the **SEL** key, then use the **▲** **▼** keys to select Adj0 ("Adj0").



- 5** Press the **SEL** key, then use the **▲** **▼** keys to select 3.0 when the bottom part of the display begins to blink.

The zero display is off by -3°C, so the compensation is of the opposite sign, 3°C.

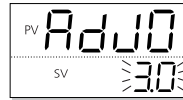

- 6** Press the **SEL** key to confirm the setting.

- 7** Set the input from the mV generator or dial resistor to 100%.

- 8** Press and hold the **SEL** key, then use the **▲** **▼** keys to select Adj5 ("Adj5").

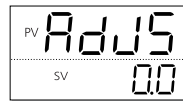

- 9** Press the **SEL** key, then use the **▲** **▼** keys to select -4.0 when the bottom part of the display begins to blink.

The span display is off by 4°C, so the compensation is of the opposite sign, -4.0°C.

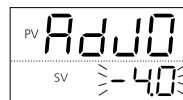

- 10** Press the **SEL** key to confirm the setting.

- 11** Press the **A/M** key to return to the operation mode PV/SV display.

Caution

Be sure to set the cold junction compensation back to "ON" when using thermocouple input.

Cold Junction Compensation

This is the procedure for turning cold junction compensation on or off when using input from a thermocouple sensor.

This setting should be left "ON" during normal operation. It should only be turned off when cold junction compensation is being performed externally or you wish to record temperature differences.



- Range on : Cold junction compensation on
oFF : Cold junction compensation off

Setting Cold Junction Compensation



- 1 Press and hold the  key to display the setup mode channel menu ("oPE Ch 1"), then use the   keys to display SET ("SEf Ch 6").

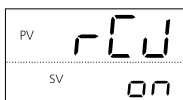

 Refer to See p. 74 in this chapter for information on how to display the operation menu.

- 2 Press and hold the  key, then use the   keys to display rCJ ("rCJ").



- 3 Press the  key, then use the   keys to select "oFF" when the bottom part of the display begins to blink.

Cold junction compensation is turned off.



- 4 Press the  key to confirm the setting.

- 5 Press the  key to return to the operation mode PV display.

Remote SV Zero Adjustment

Remote SV Span Adjustment

This function adjusts remote SV zero/span.

Use this function to match zero/span to an output gauge.

- Range: -50.0% to 50.0% FS (zero/span)

Zero/span adjustments for input in the 1-5V range are as follows:

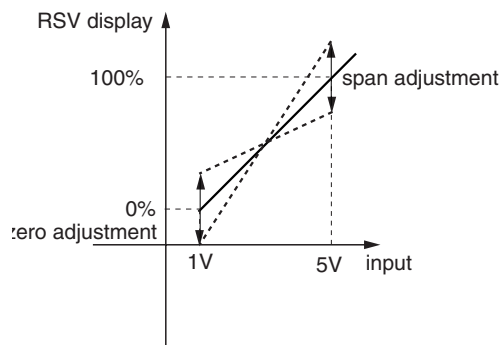

Adjusting Remote SV Zero/Span

The following steps explain how to adjust remote SV zero/span by using a zero deviation of -5% and a span deviation of 7% as an example.

- 1 Confirm the accuracy of the SV display by checking the PV display when the mV generator or dial resistor is set to 0 and 100%.

The zero display deviation is -5% and the span display deviation is 7%.

 See "Remote SV (RSV) Pin Input Display" (p. 66) for more information on confirming remote SV.

- 2 Press and hold the  key to display the setup mode channel menu ("oPE Ch 1"), then use the   keys to display SET ("SEr Ch 6").

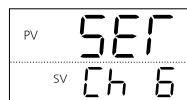



 See p. 74 in this chapter for information on how to display the operation menu.

- 3 Set the input from the mV generator to 0%.

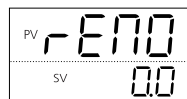
- 4 Press and hold the  key, then use the   keys to display rEM0 ("rEN0").



- 5 Press the  key, then use the   keys to select 5.0 when the bottom part of the display begins to blink.

The zero display deviance is -5%, so the correction is 5.0%.

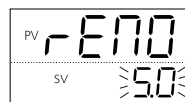



- 6 Press the  key to confirm the setting.

- 7 Set the input from the mV generator to 100%.

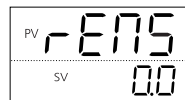
- 8 Press and hold the  key, then use the   keys to display rEMS ("rEN5").



- 9 Press the  key, then use the   keys to select -7.0 when the bottom part of the display begins to blink.

The span display deviance is 7%, so the correction is -7.0%.

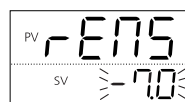

- 10 Press the  key to confirm the setting.



- 11 Press the  key to return to the operation mode PV/SV display.

Remote SV Input Range

This is the procedure for specifying the remote SV input range.



- Range 0-5: 0V to 5V
1-5: 1V to 5V

Setting the Remote SV Input Range



- 1 Press and hold the  key to display the setup mode channel menu ("oPE Ch 1"), then use the   keys to display "SEr Ch 6".

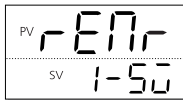

Refer to  See p. 74 in this chapter for information on how to display the operation menu.

- 2 Press and hold the  key, then use the   keys to select "rEr".



- 3 Press the  key, then use the   keys to select 0-5V when the bottom part of the display begins to blink.

The remote SV range is set to 0-5V.

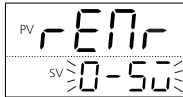

- 4 Press the  key to confirm the setting.

- 5 Press the  key to return to the operation mode PV/SV display.

rTF Remote SV Input Filter

This low-pass filter function reduces noise and signal wavering.

- Range: 0.0 sec to 120.0 sec (input filter damping)

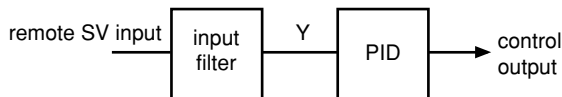

When the input suddenly steps from 0% to 100% with the input filter constant set to 5 seconds, the remote SV display will change slowly and take 5 seconds to change from 0% to 63.2%.

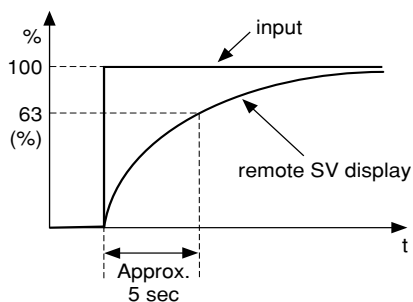

Caution

The factory setting for input filter damping is 5%. Do not change this unless absolutely necessary.

Setting the Remote SV Filter

The following steps explain how to set the remote SV filter by using 10 sec as an example.

- 1 Press and hold the **SEL** key to display the setup mode channel menu ("oPE Ch 1"), then use the **▲** **▼** keys to display SET ("SEf Ch 6").

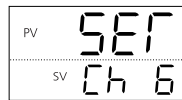

Refer to See p. 74 in this chapter for information on how to display the operation menu.

- 2 Press and hold the **SEL** key, then use the **▲** **▼** keys to display rTF ("rTF").

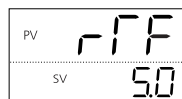

- 3 Press the **SEL** key, then use the **▲** **▼** keys to select 10.0 when the bottom part of the display begins to blink.

The remote SV input filter damping is set to 10.0 sec.



- 4 Press the **SEL** key to confirm the setting.

- 5 Press the **A/M** key to return to the operation mode PV/SV display.

C1r **OUT1 Range**

C2r **OUT2 Range**

Specifies the range for control output (OUT1/OUT2)

- Range 0-5 : 0V to 5V
- 1-5 : 1V to 5V
- 0-10 : 0mA to 10V
- 2-10 : 2V to 10V
- 0-20 : 0mA to 20mA
- 4-20 : 4mA to 20mA

Caution

Do not use 0-5, 1-5, 0-10, or 2-10 if current is selected for output 1 and output 2 in the model specifications. Do not use 0-20 or 4-20 if voltage is selected for output 1 and output 2.

The unit will not operate properly if improper settings are chosen.

Setting the OUT1/OUT2 Range

The following steps explain how to set OUT1 range by using 0mA to 20mA as an example.

- 1 Press and hold the **SEL** key to display the setup mode channel menu ("oPE Ch 1"), then use the **▲** **▼** keys to display SET ("SEr Ch 6").



See p. 74 in this chapter for information on how to display the operation menu.

- 2 Press and hold the **SEL** key, then use the **▲** **▼** keys to select C1r ("C1r").

- 3 Press the **SEL** key, then use the **▲** **▼** keys to select 0-20 when the bottom part of the display begins to blink.

The OUT1 range is set to 0mA to 20mA.

- 4 Press the **SEL** key to confirm the setting.

- 5 Repeat steps 2-4 (excluding pressing and holding the **SEL** key) to set FALT OUT2.

- 6 Press the **A/M** key to return to the operation mode PV/SV display.

FLo1 **FALT OUT1 Value**

FLo2 **FALT OUT2 Value**

This is the procedure for specifying the output value of OUT1/OUT2 should this device fall go into the FALT state (Input Error).

- Range: -3.0% to 103.0% (OUT1/OUT2)

Setting FALT OUT1/OUT2

The following steps explain how to set the FALT OUT1/OUT2 setting by using 5% as an example.

- 1 Press and hold the **SEL** key to display the setup mode channel menu ("oPE Ch 1"), then use the **▲** **▼** keys to display SET ("SEr Ch 6").

Refer to



See p. 74 in this chapter for information on how to display the operation menu.

- 2 Press and hold the **SEL** key, then use the **▲** **▼** keys to select Flo1 ("FLo 1").

- 3 Press the **SEL** key, then use the **▲** **▼** keys to select 5.0 when the bottom part of the display begins to blink.

OUT1 output is set to 5.0%.

- 4 Press the **SEL** key to confirm the setting.

- 5 Repeat steps 2-4 (excluding pressing and holding the **SEL** key) to set FALT OUT2.

- 6 Press the **A/M** key to return to the operation mode PV/SV display.

SFo1 Soft Start OUT1 Output

SFTM Soft Start Time

This function controls the maximum output produced when turning on the equipment (including the temperature controller).

The controls place an upper limit on the output for a set time period after the power is turned on.

This function is useful for effects such as suppressing the heater output during equipment startup, or lightening the load.

After the specified time has passed after switching on the equipment (or if SFTM = 0), the soft start function ends and normal controls begin.

Parameter	Function
SFo1 OUT1 set value	OUT1 is limited for the time period specified in SFTM after the power is turned on.
SFo2 OUT2 set value	OUT2 is limited for the time period specified in SFTM after the power is turned on. * This is used when there are dual outputs.
SFTM Set Time (unit: hh, mm)	Sets the time for soft start to function after turning power on. Setting "0" will turn off soft start.

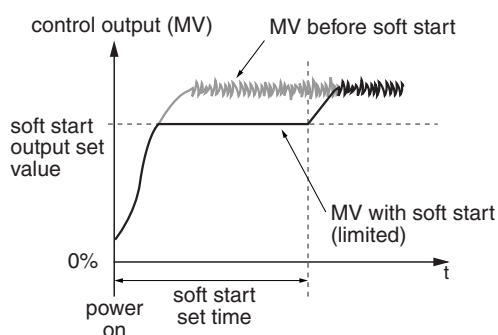

Point During manual mode, the manual output value has priority, but soft start will continue to keep track of the set time period.

Caution The soft start function cannot be used when there are dual outputs. Do not use self-tuning during soft start. The soft start may not be controlled correctly.

Setting Soft Start OUT1 Output/OUT1 Time

This section explains how to set soft start output and time by using output = 5% and time = 30 min. as an example.

- 1 Press and hold the **SEL** key to display the setup mode channel menu ("oPE Ch 1"), then use the **▲** **▼** keys to display SET ("SEr Ch 6").

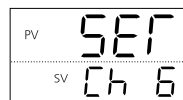

Refer to See p. 74 in this chapter for information on how to display the operation menu.

- 2 Press and hold the **SEL** key, then use the **▲** **▼** keys to display SFo1 ("SFo 1").

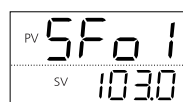

- 3 Press the **SEL** key, then use the **▲** **▼** keys to select 5.0 when the bottom part of the display begins to blink.

The OUT1 soft start output is set to 5%.



- 4 Press the **SEL** key to confirm the setting.

- 5 Repeat steps 2 to 4 (excluding pressing and holding the **SEL** key) to set OUT2.

- 6 Use the **▲** **▼** keys to select "SFTM".

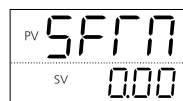

- 7 Press the **SEL** key, then use the **▲** **▼** keys to select 0.30 when the bottom part of the display begins to blink.

Soft start time is set to 30 min.



- 8 Press the **A/M** key to return to the operation mode PV/SV display.

Sbo1 Standby OUT1 Output

Sbo2 Standby OUT2 Output

This is the procedure for setting the OUT1/OUT2 values for standby mode.

- Range: -3.0% to 103.0% (OUT1/OUT2)

Setting Standby Mode OUT1/OUT2 Output

The following steps explain how to set Standby Mode OUT1/OUT2 by using 5% as an example.

- 1 Press and hold the **SEL** key to display the setup mode channel menu ("oPE [h l]), then use the **▲** **▼** keys to display SET ("SEF [h 6").

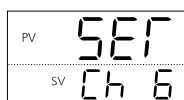

Refer to See p. 74 in this chapter for information on how to display the operation menu.

- 2 Press and hold the **SEL** key, then use the **▲** **▼** keys to display Sbo1 ("Sbo l").

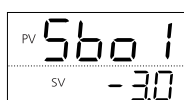

- 3 Press the **SEL** key, then use the **▲** **▼** keys to select 5.0 when the bottom part of the display begins to blink.

OUT1 output during standby is set to 5%.

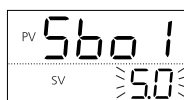

- 4 Press the **SEL** key to confirm the setting.

- 5 Repeat steps 2-4 (excluding pressing and holding the **SEL** key) to set the range for OUT2.

- 6 Press the **AM** key to return to the operation PV/SV display.

SbMd

Standby Mode Settings

This is the procedure for specifying re-transmission output, alarm output, and operation mode display in standby mode.

The following three settings are available:

- AO (Re-transmission Output)
- DO (Digital Output)
- PV/SV display (operation mode display)

These can be combined in the following four ways:

- Setting range

SbMd	AO (Re-transmission Output)	DO (Digital Output)	PV/SV display
0	ON	OFF	ON
1	ON	ON	ON
2	OFF	OFF	ON
3	OFF	ON	ON
4	ON	OFF	OFF
5	ON	ON	OFF
6	OFF	OFF	OFF
7	OFF	ON	OFF

Re-transmission output: When turned off, the re-transmission output becomes -3%.

Setting Standby Mode Output

This section explains how to set standby mode output by using AO=ON, Digital=OFF, PV/SV=ON as an example.

- 1 Press and hold the **SEL** key to display the setup mode channel menu ("oPE [h l]), then use the **▲** **▼** keys to display SET ("SEF [h 6").

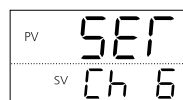

Refer to See p. 74 in this chapter for information on how to display the operation menu.

- 2 Press and hold the **SEL** key, then use the **▲** **▼** keys to select "SbMd".

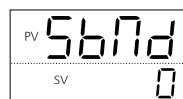

- 3 Press the **SEL** key, then use the **▲** **▼** keys to select 0 when the bottom part of the display begins to blink.

Standby mode output is set to "AO = ON, ALM = OFF, PV/SV = ON".

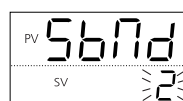

- 4 Press the **SEL** key to confirm the setting.

- 5 Press the **AM** key to return to the operation mode PV/SV display.

AoT AO Output Type



This is the procedure to specify what output is re-transmitted.

The following five settings are available:

- Range Pv: Measurement
Sv: Set value
Mv: Control output
Dv: Variable (PV-SV)



Setting AO Output Type

The following steps explain how to set AO output by using SV as an example.



- 1 Press and hold the  key to display the setup mode channel menu ("oPE [h 1]"), then use the   keys to display SET ("SEf [h 6]").

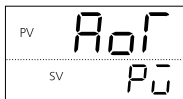

 **Refer to** See p. 74 in this chapter for information on how to display the operation menu.

- 2 Press and hold the  key, then use the   keys to select AoT ("AoT").



- 3 Press the  key, then use the   keys to select "SV" when the bottom part of the display begins to blink.

Re-transmission output type is set to SV.

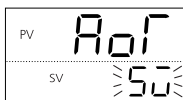

- 4 Press the  key to confirm the setting.

- 5 Press the  key to return to the operation mode PV/SV display.

Aol AO Lower Limit Scaling

Aoh AO Upper Limit Scaling

This is the procedure for specifying the upper and lower limits of re-transmission input.

- Range: -100% to 100% FS (Upper/lower limit)

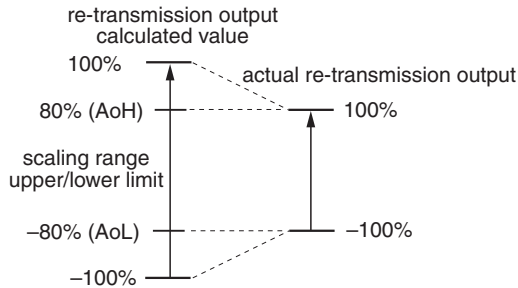

Calculate the set value with the following equation. (Use the example set value below as a reference.)

$$\text{Set value (\%)} = (A \div B) \times 100 [\%]$$

$$A = (\text{Desired temperature}) - (\text{Set value of parameter "P\u0304\u0304b"})$$

$$B = (\text{Set value of parameter "P\u0304\u0304F"}) - (\text{Set value of "P\u0304\u0304b"})$$

- When the value of the re-transmission output type (ex: SV) is equal to the AoL set value, the re-transmission output will be 0% (output).
- When the value of the re-transmission output type (ex: SV) is equal to the AoH set value, the re-transmission output will be 100% (output).

Caution

Make sure to set the value of AoH greater than AoL.

Setting AO Upper/Lower Limit Scaling

The following steps explain how to set AO limit scaling by using -80% to 80% as an example.

- 1 Press and hold the SEL key to display the setup mode channel menu ("oPE Ch 1"), then use the ▲ ▼ keys to display SET ("SEr Ch 6").



See p. 74 in this chapter for information on how to display the operation menu.

- 2 Press and hold the SEL key, then use the ▲ ▼ keys to select AoL ("Aol").

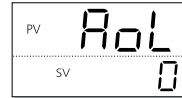

- 3 Press the SEL key, then use the ▲ ▼ keys to select -80 when the bottom part of the display begins to blink.

The AO lower limit is set to "-80%".

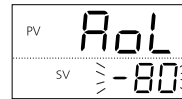

- 4 Press the SEL key to confirm the setting.

- 5 Repeat steps 2 to 4 (excluding pressing and holding the SEL key) to set the AO upper limit ("Aoh") to 80%.

- 6 Press the A/M key to return to the operation mode PV/SV display.

MEMO

Chapter 9

System Parameters (Ch7)

Overview of System Parameters (Ch7) – 90
USER Key Assignments – 93
DI Function Select – 94
DO Event Type – 96
DO Option Functions – 98
Ramp SV ON/OFF, Ramp SV decline, Ramp SV incline, Ramp SV slope time unit – 99
SV Display Mode – 100
Control Method – 101
Control Target – 108
HYS mode setting – 110

Overview of System Parameters (Ch7)

This section explains system parameters, which specify the basic operations and controls of this device.

The following settings are available

- USER key () function settings
- DI function settings
- DO function settings
- SV ramp rate settings
- Control methods
- Power on mode settings

Display	Parameter name	Function	Setting range	Initial value	Remarks	Page
"UkEy" (UkEy)	USER key allocation settings	Sets the function of the [USER] key	0 (no function) 1 (Switches between STBY ON/OFF) 2 (Switches between Auto/Manual) 3 (Switches between Local/Remote) 4 (Do not set) 5 (Starts AT (standard)) 6 (Starts AT (low PV)) 7 (Do not set) 8 (Ramp SV HOLD) 9 (Ramp/soak RUN/OFF) 10 (Ramp/soak RUN/HOLD) 11 (Do not set) 12 (Latch cancel (all)) 13 (Latch cancel (DO1)) 14 (Latch cancel (DO2)) 15 (Latch cancel (DO3)) 16 (Latch cancel (DO4)) 17 (Latch cancel (DO5)) 18 (Start timer (DO1)) 19 (Start timer (DO2)) 20 (Start timer (DO3)) 21 (Start timer (DO4)) 22 (Start timer (DO5)) 23 (SV No.+1 (send)) 24 (PID No. +1 (send)) 25 (Do not set) 26 (Pattern No.+1 (send)) 27 (SV No. + 1, PID No. + 1 (send))	2	RST	93
"di1" (di1)	DI-1 function select	Sets the function of DI-1	0 (no function) 1 (Switches between STBY ON/OFF) 2 (Switches between Auto/Manual) 3 (Switches between Local/Remote) 4 (Do not set) 5 (Do not set) 6 (Start AT (standard)) 7 (Start AT (low PV)) 8 (Do not set) 9 (Do not set) 10 (Ramp SV ON/OFF) 11 (Ramp SV HOLD) 12 (Ramp/soak RUN/OFF) 13 (Ramp/soak RUN/HOLD) 14 (Do not set) 15 (Latch cancel (all)) 16 (Latch cancel (DO1)) 17 (Latch cancel (DO2)) 18 (Latch cancel (DO3)) 19 (Latch cancel (DO4)) 20 (Latch cancel (DO5)) 21 (Start timer (DO1)) 22 (Start timer (DO2)) 23 (Start timer (DO3)) 24 (Start timer (DO4)) 25 (Start timer (DO5)) 26 (SV No.+1) 27 (SV No.+2)	0	Note 1 RST	94

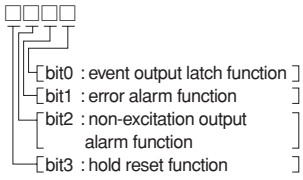
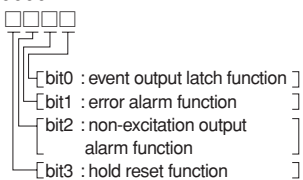
Display	Parameter name	Function	Setting range	Initial value	Remarks	Page
"di1" (di1)	DI-1 function select	Sets the function of DI-1	28 (SV No.+4) 29 (PID No.+1) 30 (PID No.+2) 31 (PID No.+4) 32 (no function) 33 (no function) 34 (no function) 35 (SV No., PID No. + 1) 36 (SV No., PID No. + 2) 37 (SV No., PID No. + 4) 38 (Pattern No.+1) 39 (Pattern No.+2) 40 (Pattern No.+4) 41 (DI soft start) 42 (Ramp soak RUN) 43 (Ramp soak HOLD) 44 (Ramp soak RUN at DO1 startup) 45 (Ramp soak RUN at DO2 startup) 46 (Ramp soak RUN at DO3 startup) 47 (Ramp soak RUN at DO4 startup) 48 (Ramp soak RUN at DO5 startup)	0	Note 1 RST	94
"di2" (di2)	DI-2 function select	Sets the function of DI-2	0-48	0		
"di3" (di3)	DI-3 function select	Sets the function of DI-3	0-48	0		
"di4" (di4)	DI-4 function select	Sets the function of DI-4	0-48	0		
"di5" (di5)	DI-5 function select	Sets the function of DI-5	0-48	0		
"do1T" (do1T)	DO1 output event type	Sets the trigger that causes DO1 output.	0-102	0	Note 2 RST	96
"doP1" (doP1)	DO1 option function setting	Assigns the four types of option functions in bit units	0000-1111 	0000		98
⋮	⋮	⋮	⋮	⋮		⋮
"do5T" (do5T)	DO5 output event type	Sets the trigger that causes DO5 output.	0-102	0		96
"doP5" (doP5)	DO5 option function setting	Assigns the four types of option functions in bit units	0000-1111 	0000		98
"rMP" (rMP)	ramp SV ON/OFF	Set the ramp SV ON/OFF	OFF(ramp SV OFF) ON(ramp SV ON)	ON		
"rMPL" (rMPL)	Ramp SV -n Decline	Sets the rate of ramp SV upslope.	0% to 100% FS/°C (Industrial value)	0°C	RST	99
"rMPH" (rMPH)	Ramp SV - Incline	Specifies the rate of ramp SV upslope.	0% to 100% FS/°C (Industrial value)	0°C		
"rMPU" (rMPU)	Ramp SV slope time units	Sets the time unit for the ramp SV slope	hoUr (slope degree/hr) Min (slope degree/min)	hoUr	RST	
"SVT" (SVT)	Ramp SV SV display mode selection	Displays either the target SV or current SV during ramp operations	rMP (Display current ramp SV) TrG (Display target SV)	rMP		100
"CTrL" (CTrL)	Control methods	Allows you to select the control method.	Pid (Pid control) FUZY (Fuzzy Pid control) SELF (Self-tuning control) Pid2 (Pid2 control)	Pid	Note 3	101

Display	Parameter name	Function	Setting range	Initial value	Remarks	Page
"PrCS" (PrCS)	Control target	Allows you to select the control target.	Srv1 (servo control 1) Srv2 (servo control 2) PFB (position feedback control)	PFb/ Srv1 (PFB on/ PFB off)	Note 4	108
"onoF" (onoF)	HYS mode setting	Selects the hysteresis operation during two state action.	OFF: Performs two state action at $SV \pm HYS/2$. ON: Performs two state action at SV, SV+HYS and SV, SV-HYS.			110
"STMd" (STMd)	Startup mode	Sets the operation mode when starting up	AUTo (Auto mode startup) MAAn (Manual mode startup) rEM (Remote mode startup) STby (Standby mode startup)	AUTo		110

Note 1: The number of parameters displayed changes depending on the number of points of DI.

Note 2: The displayed content changes depending on the number of points of DO or the selected alarm type.

Note 3: Be sure to select PID control when the fifth digit of the model number is S or V. Control other than PID control cannot be used.



Note 4: Displays when the fifth digit of the model number is V or S.

Note 5: When the parameter with [RST] in its "Remarks" column is changed, turn the power to the unit off and on again.

Note 6: The range of the parameters in the shaded area indicates the industrial values.

UKEY USER Key Assignments

This device includes a  key, which has the following two functions.

When to press the  key	How long to press the  key	Operations when pressing the  key
Displays other than operation mode	One click	Jumps to channel menu, parameter menu from operation mode
Operation mode	Press and hold (about two seconds)	Performs the operation assigned to the USER key

Select the USER key assignments from the following.

Setting	Function	Remarks
0	No function	
1	Switch between standby ON/OFF	
2	Switches between auto/manual mode	Initial value
3	Switches between local/remote	
4	(Do not set)	
5	Starts auto-tuning (standard)	
6	Starts auto-tuning (low PV)	
7	(Do not set)	
8	Switches between ramp SV hold/release	
9	Switches between ramp/soak RUN/OFF	
10	Switches between ramp/soak RUN/HOLD	
11	(Do not set)	
12	Cancel all latches	
13	DO1 latch cancel	
14	DO2 latch cancel	
15	DO3 latch cancel	
16	DO4 latch cancel	
17	DO5 latch cancel	
18	DO1 timer start	
19	DO2 timer start	
20	DO3 timer start	
21	DO4 timer start	
22	DO5 timer start	
23	SV No.+1 send *	
24	PID No.+1 send *	
25	(Do not set)	
26	Pattern No.+1 send **	
27	SV No. and PID No. +1 send simultaneously *	

Caution

* : Returns to No.1 when reached to the Max No.
 **: Returns to the Min No. when reached to the Max No.

Setting USER Key Assignments



The follow steps explain how to set USER key assignments by using switch between standby ON/OFF as an example.

Operation mode

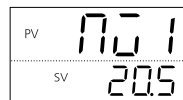

- 1 Press and hold the  key to display "MV 1". The monitoring mode MV1 is displayed.



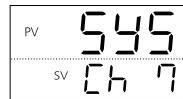

- 2 Press and hold the  key to display the setup mode channel menu ("oPE Ch 1"), then use the   keys to display SYS ("SYS Ch 7").

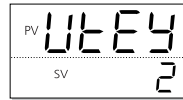

- 3 Press and hold the  key, then use the   keys to select UKEY ("UKEY").



- 4 Press the  key, then use the   keys to select 1 when the bottom part of the display begins to blink.

DI1 is now set to switch between standby on/off.

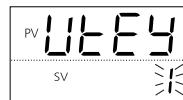

- 5 Press the  key to confirm the setting.

- 6 Press the  key to return to the operation mode PV/SV display.

DI Function Select

DI1 to DI5 can each be assigned a function. The assigned functions activate when an external digital signal is input.

Select from the following.

Dis play	Function Name	Behavior	ON	OFF	Judgment condition
"0"	No function	Nothing happen	-	-	-
"1"	Switchover between standby ON/OFF	Switches between standby on and off	Standby	Standby Cancel	Edge
"2"	Switchover between auto/manual	Switches between auto and manual control output	Manual	Auto	Edge
"3"	Switchover between local/remote	Switches between local and remote SV	Remote	Local	Edge
"4"	No function	Do not set	-	-	-
"5"	No function	Do not set	-	-	-
"6"	Auto-tuning (standard) Start	Starts standard auto-tuning	Start	Stop	Edge
"7"	Auto-tuning (low PV) Start	Starts low PV auto-tuning	Start	Stop	Edge
"8"	No function	Do not set	-	-	-
"9"	No function	Do not set	-	-	-
"10"	Ramp SV on/off.	Enables or disables ramp SV.	Disable	Enable	Edge
"11"	Ramp SV HOLD	Switches between ramp SV HOLD and HOLD cancel	HOLD	HOLD cancel	Edge
"12"	Ramp Soak OFF	Turns ramp soak off	OFF	-	Edge
"13"	Ramp Soak RUN/HOLD	Switches between RUN and HOLD.	RUN	HOLD	Edge
"14"	No function	Do not set	-	-	-
"15"	Latch release (all)	Cancels all of the sources currently acting as latches.	-	-	Edge
"16"	Latch release (DO1)	Cancels the source currently acting as a latch on DO1.	Cancel	-	Edge
"17"	Latch release (DO2)	Cancels the source currently acting as a latch on DO2.	-	-	-
"18"	Latch release (DO3)	Cancels the source currently acting as a latch on DO3.	-	-	-
"19"	Latch release (DO4)	Cancels the source currently acting as a latch on DO4.	-	-	-
"20"	Latch release (DO5)	Cancels the source currently acting as a latch on DO5.	-	-	-
"21"	Start timer (DO1)	Starts the specified timer for DO1.	Timer ON	Timer OFF	Level
"22"	Start timer (DO2)	Starts the specified timer for DO2.	-	-	-
"23"	Start timer (DO3)	Starts the specified timer for DO3.	-	-	-
"24"	Start timer (DO4)	Starts the specified timer for DO4.	-	-	-
"25"	Start timer (DO5)	Starts the specified timer for DO5.	-	-	-
"26"	SV No. + 1	When selecting SV No., increases the SV No. by 1.	+1	-	Level
"27"	SV No. + 2	When selecting SV No., increases the SV No. by 2.	+2	-	Level
"28"	SV No. + 4	When selecting SV No., increases the SV No. by 4.	+4	-	Level
"29"	PID No. + 1	When selecting PID No., increases the PID No. by 1.	+1	-	Level
"30"	PID No. + 2	When selecting PID No., increases the PID No. by 2.	+2	-	Level



Dis play	Function Name	Behavior	ON	OFF	Judgment condition
"31"	PID No. + 4	When selecting PID No., increases the PID No. by 4.	+4	-	Level
"32"	No function	Do not set	-	-	-
"33"	No function	Do not set	-	-	-
"34"	No function	Do not set	-	-	-
"35"	SV No.+1, PID No.+1	When selecting SV No. and PID No., increases the SV No. and PID No. by 1.	+1	-	Level
"36"	SV No.+2, PID No.+2	When selecting SV No. and PID No., increases the SV No. and PID No. by 2.	+2	-	Level
"37"	SV No.+4, PID No.+4	When selecting SV No. and PID No., increases the SV No. and PID No. by 4.	+4	-	Level
"38"	Pattern No.+1	When selecting pattern No., increases the Pattern No. by +1	+1	-	Level
"39"	Pattern No.+2	When selecting pattern No., increases the Pattern No. by +2	+2	-	Level
"40"	Pattern No.+4	When selecting pattern No., increases the Pattern No. by +4	+4	-	Level
"41"	Soft start	Starts the soft start	Soft start ON	-	Edge
"42"	Ramp soak RUN	Sets the ramp soak to RUN.	RUN	-	Edge
"43"	Ramp soak HOLD	Sets the ramp soak to HOLD.	HOLD	-	Edge
"44"	Delay start(DO1)	Enables delay start with the delay time = dLY1.	Delay start enable		-
"45"	Delay start(DO2)	Enables delay start with the delay time = dLY2.	Delay start enable		-
"46"	Delay start(DO3)	Enables delay start with the delay time = dLY3.	Delay start enable		-
"47"	Delay start(DO4)	Enables delay start with the delay time = dLY4.	Delay start enable		-
"48"	Delay start(DO5)	Enables delay start with the delay time = dLY5.	Delay start enable		-

Caution

- When the DI function for edge operations is selected, and the power to the unit is turned on with DI turned on, the ON edge is accepted and the selected function is performed.
- When the DI function for edge operations is selected, even if the power to the unit is turned on with DI turned off, the OFF edge is not accepted and the selected function is not performed.



Selecting DI Function

The following steps explain how to set DI functions by using DI1 = switches between standby ON/OFF as an example.



- 1 Press and hold the  key to display the setup mode channel menu ("oPE Ch 1"), then use the   keys to display SYS ("545 Ch 7").

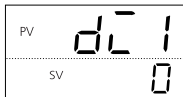

Refer to  See p. 93 in this chapter for information on how to display the channel menu.

- 2 Press and hold the  key, then use the   keys to display di1 ("dL 1").



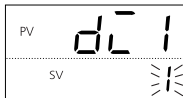

- 3 Press the  key, then use the   keys to select 1 when the bottom part of the display begins to blink.

DI1 is now set to switch between standby on/off.



- 4 Press the  key to confirm the setting.

- 5 Repeat steps 2 to 4 (excluding pressing and holding the  key) to assign other DI settings.

- 6 Press the  key to return to the operation mode PV/SV display.

Sets the trigger to turn DO on.

Select from the following.

Class	DO1 to DO5	Alarm Type	Behavior diagram
	0	No alarm	—
Absolute Alarm	1	Upper limit absolute	
	2	Lower limit absolute	
	3	Upper limit absolute (w/ hold)	
	4	Lower limit absolute (w/ hold)	
Deviation Alarm	5	Upper limit deviation	
	6	Lower limit deviation	
	7	Upper/lower limit deviation	
	8	Upper limit deviation (w/ hold)	
	9	Lower limit deviation (w/ hold)	
	10	Upper/lower limit deviation (w/ hold)	
Range Alarm	11	Range upper/lower limit deviation (ALN1/2 function independently)	
	12 Note 1	Range upper/lower limit absolute	
	13 Note 1	Range upper/lower limit deviation	
	14 Note 1	Range upper limit absolute Lower limit deviation	
	15 Note 1	Range upper limit deviation Lower limit absolute	

Note 1: Only DO2 can be set.

● Dual Set Value Alarm Codes

Class	DO1 to DO5	Alarm Type	Behavior diagram	
Upper/lower limit Alarm	16	Upper/lower limit absolute		
	17	Upper/lower limit deviation		
	18	Upper limit absolute, lower limit deviation		
	19	Upper limit deviation, lower limit absolute		
	20	Upper/lower limit absolute (w/ hold)		
	21	Upper/lower limit deviation (w/ hold)		
	22	Upper limit absolute, lower limit deviation (w/ hold)		
	23	Upper limit deviation, lower limit absolute (w/ hold)		
	Range Alarm	24	Range upper/lower limit absolute	
		25	Range upper/lower limit deviation	
26		Range upper limit absolute Lower limit deviation		
27		Range upper limit deviation Lower limit absolute		
28		Range upper/lower limit absolute (w/ hold)		
29		Range upper/lower limit deviation (w/ hold)		
30		Range upper limit absolute, lower limit deviation (w/ hold)		
31		Range upper limit deviation, lower limit absolute (w/ hold)		

● Timer Code

Class	DO1 to DO5	Alarm Type	Behavior diagram
Timer	32	Delay on timer	
	33	Delay off timer	
	34	Delay ON/OFF timer	

● Ramp soak delay start

Class	DO 1 to 5	Function
Ramp soak delay start	35	Delay start ON

● Break/Short-Circuit Alarm

Class	DO 1 to 5	Function
Break/ Short-Circuit Warning	41 44 47	Loop break alarm Heater break alarm Load short-circuit alarm

● Condition Output

Class	DO 1 to 5	Function
Condition Output	51	During auto-tuning
	52	Normal Operation
	53	Standby
	54	Manual Mode operating
	55	Remote SV operating
	56	During ramp SV
Ramp/Soak Event Output	60	OFF state
	61	RUN state
	62	HOLD state
	63	GS (guaranteed soale) state
	65	END state
Time Signal	71	Time signal (1st segment)
	72	Time signal (2nd segment)
	73	Time signal (3rd segment)
	74	Time signal (4th segment)
	75	Time signal (5th segment)
	76	Time signal (6th segment)
	77	Time signal (7th segment)
	78	Time signal (8th segment)
	79	Time signal (9th segment)
	80	Time signal (10th segment)
	81	Time signal (11th segment)
	82	Time signal (12th segment)
	83	Time signal (13th segment)
	84	Time signal (14th segment)
	85	Time signal (15th segment)
	86	Time signal (16th segment)
	87	Time signal (17th segment)
	88	Time signal (18th segment)
	89	Time signal (19th segment)
	90	Time signal (10th segment)
	91	Time signal (21st segment)
	92	Time signal (22nd segment)
	93	Time signal (23rd segment)
	94	Time signal (24th segment)
	95	Time signal (25th segment)
	96	Time signal (26th segment)
	97	Time signal (27th segment)
	98	Time signal (28th segment)
	99	Time signal (29th segment)
	100	Time signal (30th segment)
	101	Time signal (31st segment)
	102	Time signal (32nd segment)

Setting DO Option Functions

The following steps explain how to set Do event types by using absolute upper limit alarm as an example.

- 1 Press and hold the **SEL** key to display the setup mode channel menu ("oPE Ch 1"), then use the **▲** **▼** keys to display SYS ("545 Ch 7").

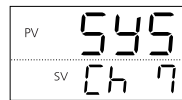

Refer to See p. 93 in this chapter for information on how to display the channel menu.

- 2 Press and hold the **SEL** key, then use the **▲** **▼** keys to display do1T ("do 1T").

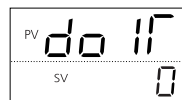

- 3 Press the **SEL** key, then use the **▲** **▼** keys to select 1 when the bottom part of the display begins to blink.

DO1 is set to absolute upper limit alarm.

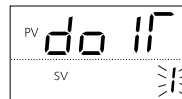

- 4 Press the **SEL** key to confirm the setting.

- 5 Repeat steps 2 to 4 (excluding pressing and holding the **SEL** key) to set other DO functions.

- 6 Press the **AM** key to return to the operation mode PV/SV display.

DO1 to DO5 can each have an optional function set. The four types of optional functions are assigned in bit units.

- Range: 0000 to 1111

Each of DO1 to DO3 can be assigned the following functions (events). The functions are divided into two categories for when they behave as alarms and when they behave as events.

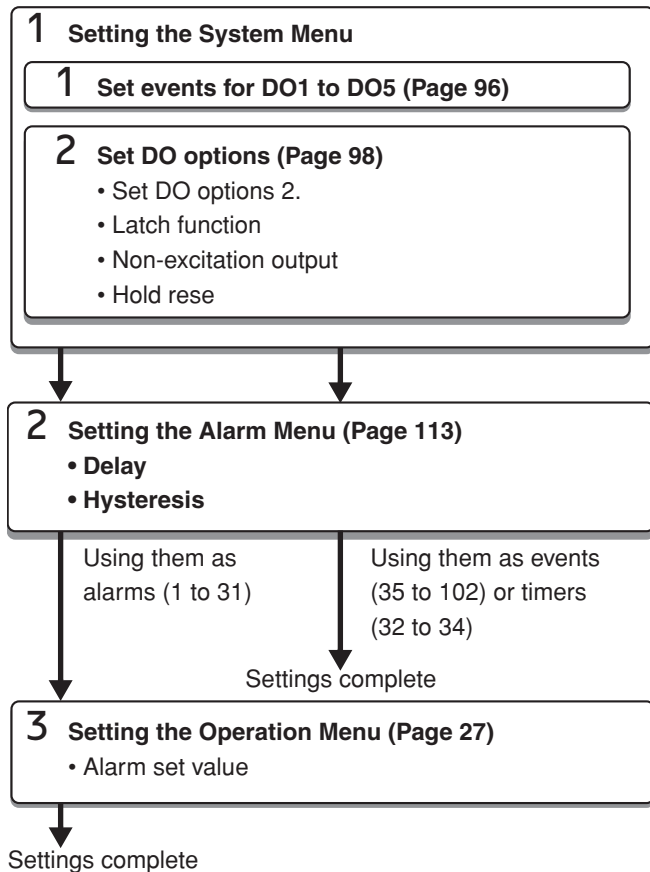

Point The non-excitation output alarm can be imitated in software by changing from connection a to connection b. It becomes connection a when power is cut.

bit0	Event output latch function	Latches (maintains) the state when an event occurs.
bit1	Error input alarm function	Outputs when an abnormal input ("UUUU" or "LLLL" is displayed) enters the unit. Set the DO event to "0" to use this function.
bit2	Non-excitation output alarm function	Inverts the output and outputs from the DO terminal when an event occurs.
bit3	Hold reset function	When an alarm with hold is applied, the hold function is reset when any of the following actions occur: Change SV value/Change alarm type/Change alarm settings/Cancel standby/Turn power off and on

Setting DO Option Functions

The following steps explain how to set DO option functions by using "alarm latch function" and "non-excitation output alarm" for DO1 as an example.

- 1 Press and hold the **SEL** key to display the setup mode channel menu ("oPE Ch 1"), then use the **▲** **▼** keys to display SYS ("SYS Ch 7").

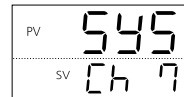

Refer to See p. 93 in this chapter for information on how to display the channel menu.

- 2 Press and hold the **SEL** key, then use the **▲** **▼** keys to display doP1 ("doP 1").



- 3 Press the **SEL** key, then use the **▲** **▼** keys to select 0101 when the bottom part of the display begins to blink. DO1 "alarm latch function" and "non-excitation output alarm" options are active.



- 4 Press the **SEL** key to confirm the setting.

- 5 Repeat steps 2 to 4 (excluding pressing and holding the **SEL** key) to set other DO option functions.

- 6 Press the **AM** key to return to the operation mode PV/SV display.

rNP Ramp SV ON/OFF

rNPL Ramp SV decline

rNPh Ramp SV incline

rNPU Ramp SV slope time unit

This function changes a previously set SV to the new value at the ramp rate.

SV does not change stepwise, but smoothly. Incline and decline rates can be set independently.

- Setting range
 - Ramp SV-incline/decline: 0% to 100% FS/°C
 - Ramp SV slope time units - hoUr (Slope deg/hr)
 - Min (Slope deg/min)

Operation is as follows for changing SV.

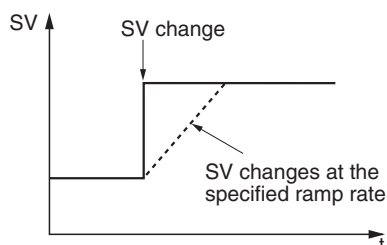

Setting Ramp SV

The following steps explain how to set ramp SV by using incline = 10°C/min and decline = 5°C/min as an example.

- Press and hold the **SEL** key to display the setup mode channel menu ("oPE [h 1]"), then use the **▲** **▼** keys to display SYS ("oPE [h 7]").

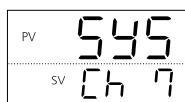

Refer to See p. 93 in this chapter for information on how to display the channel menu.

- Use the **▲** **▼** keys to display rMP ("rNP").

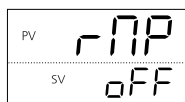

- Press the **SEL** key, then use the **▲** **▼** keys to select on when the bottom part of the display begins to blink.

The ramp SV set on.

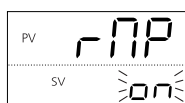

- Use the **▲** **▼** keys to display rMPL ("rNPL").

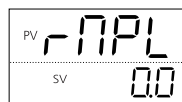

- Press the **SEL** key, then use the **▲** **▼** keys to select 5.0 when the bottom part of the display begins to blink.

The decline is now 5°C/min.



- Press the **SEL** key to confirm the setting.

- Set the ramp SV incline to 10°C/min.

- Use the **▲** **▼** keys to display rMPU ("rNPU").



- Press the **SEL** key, then use the **▲** **▼** keys to select "Min".

The time unit is deg/min.

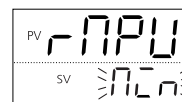

- Press the **AM** key to return to the operation mode PV/SV display.

Point

The ramp operation becomes as follows depending on the setting range of "rMPL" and "rMPh".
 Other than "0": The ramp operation setting is enabled.
 "0": The ramp operation ends, or ramp operation is not performed.

SV Display Mode

The target or current SV can be displayed during ramp SV.

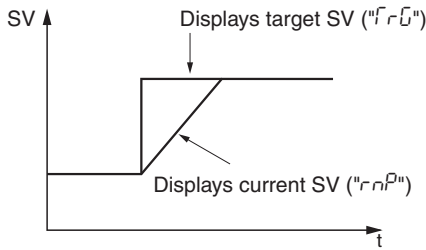

Setting the SV Display Mode

The following steps explain how to set the SV display mode by using target SV as an example.

- 1 Press and hold the **SEL** key to display the setup mode channel menu ("oPE Ch 1"), then use the **▲** **▼** keys to display SYS ("SYS Ch 7").

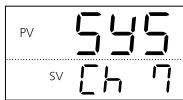

Refer to See p. 93 in this chapter for information on how to display the channel menu.

- 2 Press and hold the **SEL** key, then use the **▲** **▼** keys to display SvT ("SvT").

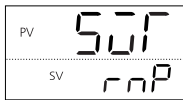

- 3 Press the **SEL** key, then use the **▲** **▼** key to select "TrG" when the bottom part of the display begins to blink.

The target SV is set to be displayed.



- 4 Press the **SEL** key to confirm the setting.

- 5 Press the **AM** key to return to the operation mode PV/SV display.

Control Method

This controller has five temperature control functions and three valve control functions. Select the best combination for the current application.

● Temperature Control Functions

ON/OFF (2 settings) Control	Switches output control ON/OFF according to the SV/PV magnitude relationship. Control systems can be built from simple elements such as SSR. This is appropriate for situations which require a low degree of accuracy.
PID Controls	PID calculation and controls proceed according to the previously set PID parameters. PID parameters can be set manually or through auto-tuning (AT). It is the most basic control in this equipment.
Fuzzy PID Control	Reduces the amount of overshoot during control. It is effective when you want to suppress overshoot while changing SV, even during processes where it may take a long time to reach the target value.
Self-tuning Control	Adds controls while automatically calculating PID to meet the control target or changing SV. It is effective when the control conditions change frequently.
Pid2 Control	Suppresses the amount of overshoot during control for processes that turn the control target off and then on again. It is effective when the control target turns on and off while power flows continuously to the temperature controller.

ON/OFF (2 setting) control

Operates as ON/OFF control when the PID parameter ("P") is set to 0.0 ("P Ld Ch 2").

ON/OFF control switches the control output to ON (100%) or OFF (0%) according to the SV/PV magnitude relationship. The output hysteresis can be set under the parameter "hYS" ("P Ld Ch 2").

Reverse Operation (Heating)

Method used to control the electrical heating furnace. Set the hYS to an appropriate value according to the control target.

Parameter	Set Value
"P"	0.0
"rEÜ"	rv--
"hYS"	Optional

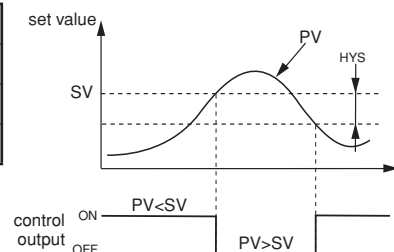

Normal Operation (Cooling)

Method used to control the cooling machine.

Parameter	Set Value
"P"	0.0
"rEÜ"	no--
"hYS"	Optional

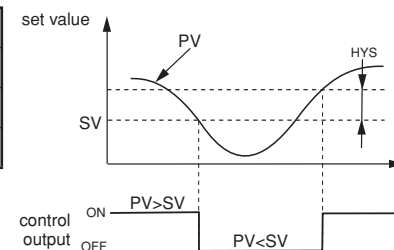

Point

- During ON/OFF control, the I and D settings do not affect control.
- This unit has five temperature control functions. Select the best function for the current application.
- If the hysteresis width is narrow, and PV and SV are nearly equal, the output may frequently switch on and off. Note that doing so may affect the operation life of the contact output.

PID Control

Operates as Pid control when the parameter "P" is not set to 0.0 ("Pcd Ch 2"), and "Ctrl" is equal to Pid ("545 Ch 7"). Pid controls calculate Pid and output the result according to the set values of the parameters "P", "I", "d", and "Rr". (-3% to 103%) Each parameter can be set either by manually tuning the values or by running auto-tuning (AT) to automatically set the values.

Refer to See "Auto-tuning" for more about the auto-tuning function. (p. 25)

Setting PID Control

The following steps explain how to change the control method to Pid.

- 1 Press and hold the **SEL** key to display the setup mode channel menu ("oPE Ch 1"), then use the **▲** **▼** keys to display SYS ("545 Ch 7").



Refer to See p. 93 in this chapter for information on how to display the channel menu.

- 2 Press and hold the **SEL** key then use the **▲** **▼** keys to display CTrL ("Ctrl").



- 3 Press the **SEL** key, then use the **▲** **▼** keys to display "Pid" when the bottom part of the display begins to blink.

This sets the control to Pid.



- 4 Press the **SEL** key to confirm the setting.

- 5 Press the **AM** key to return to the operation mode PV/SV display.

Fuzzy PID Control

This control minimizes the overshoot compared to normal PID. Fuzzy control can only be used after auto-tuning has been activated and a PID set.

Changing to Fuzzy PID Control

- 1 Press and hold the **SEL** key to display the setup mode channel menu ("oPE Ch 1"), then use the **▲** **▼** keys to display SYS ("545 Ch 7").

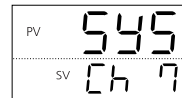

Refer to See p. 93 in this chapter for information on how to display the channel menu.

- 2 Press and hold the **SEL** key then use the **▲** **▼** keys to display CTrL ("Ctrl").

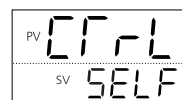

- 3 Press the **SEL** key, then use the **▲** **▼** keys to select "FUZY" when the bottom part of the display begins to blink.

Fuzzy control is set.



- 4 Press the **SEL** key to confirm the setting.

- 5 Press the **AM** key to return to the operation mode PV/SV display.

Self-tuning Control

Adds controls while automatically calculating PID to for a changing control target or set temperature (SV).

Self-tuning is especially effective for situations when a high level of control is not needed, but auto-tuning cannot be run due to frequent changes in the control target conditions.

Point

If a high degree of control is required, select fuzzy control or PID2 control and activate auto-tuning to set PID.

Conditions where self-tuning can be used

Self-tuning is used in the following situations:

- When temperature rises when the power is turned on
- When temperature rises when SV changes (or when the controller decides it is necessary)
- When the controller decides it is necessary because the controls have become unstable

Conditions where self-tuning cannot be used

Self-tuning cannot be used in the following situations:

- During control standby
- During ON/OFF (2 setting) control
- During auto-tuning
- During ramp/soak progress
- When there is error input
- When set for dual output
- When one of the P, I, D, or Ar parameters are set to manual
- During manual mode
- During ramp/soak progress

Conditions to halt self-tuning

Halt self-tuning in the following situations:

- When SV is changed (including when SV is changed by the ramp/soak function, remote SV function, or ramp SV.)
- When self-tuning has not finished after running for nine or more hours

Caution

- The PID parameters after auto-tuning has finished will be saved even if power is cut off. If power is cut off before auto-tuning is finished, PID parameters will not be changed and auto-tuning will need to be restarted.
- Control reverts to ON/OFF (2 setting) during auto-tuning, so some processes may experience large changes in PV. If you are running a process that cannot accommodate large changes in PV, do not use auto-tuning. Auto-tuning is also not suitable for processes requiring rapid response to voltage or flow controls.
- Auto-tuning is not behaving normally if it has not finished after four or more hours have passed. In these cases, recheck parameters such as input/output wiring, control output behavior (normal/reverse), and input sensor type.
- Rerun auto-tuning if there is a large change in SV, a change in the PV input type, or a change in the control target conditions that reduces the effectiveness of the controls.
- You can run auto-tuning when the control type is set to "fuzzy" or "PID2".
- You cannot run auto-tuning in manual mode.
- When using the PID selection function, the result of auto-tuning is stored in the selected PID group.
- When SV is changed by the ramp/soak function, remote SV function, or ramp SV function, auto-tuning is forcibly terminated.

Setting Self-Tuning

Operation mode



1 Use the keys to set SV.

2 Press and hold the key to display "NO1".
The monitoring mode MV1 is displayed.

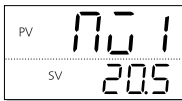

3 Press and hold the key to display the setup mode channel menu ("oPE Ch 1"), then use the keys to display SYS ("545 Ch 7").

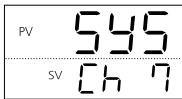

4 Press and hold the key then use the keys to display CTrl ("Ctrl").



5 Press the key, then use the keys to display "SELF" when the bottom part of the display begins to blink.



6 Press the key to confirm the setting.

7 Turn off power to the controller.

8 Turn on power to the control target equipment and the controller.

Turn on power to the control equipment first.
Self-tuning will begin.

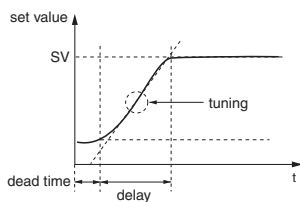

Point

- The equipment will not tune correctly if power to the controller is turned on first.
- When redoing the self-tuning settings, first set the control method to PID ("PID") again before changing back to self-tuning.

About Self-Tuning Methods

Self-tuning can calculate the PID one of two ways. Either self-tuning method will calculate values automatically depending on the characteristics of the controlled device.

- Stepwise
- Limit Cycle

The following figures depict behavior supplying power to the device, a change in the SV and a loss of control.

● Behavior at power-on

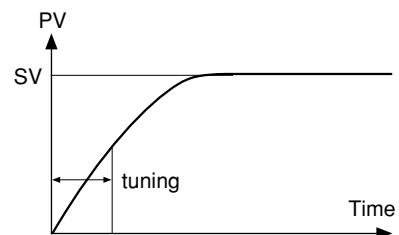

Stepwise

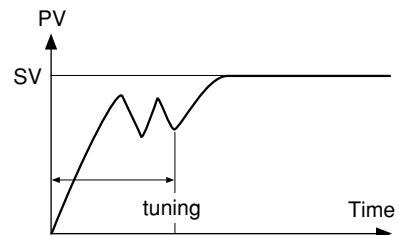

Limit Cycle

● Behavior when SV changes

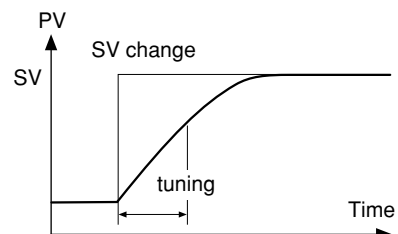

Stepwise

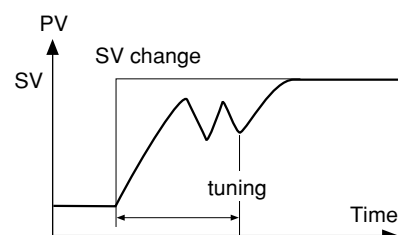

Limit Cycle

● Behavior when control is lost

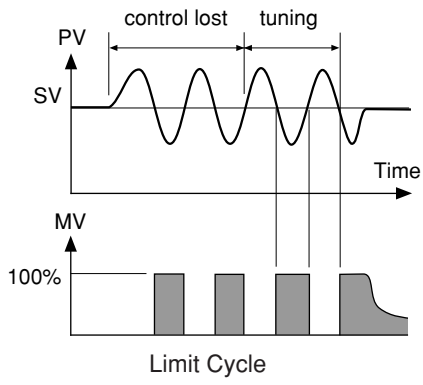

PID2 Control

This type of control reduces overshoot during control for processes that turn the control target off and then on again. The algorithm used prevents overintegration of the PID calculations even while the control loop is still open. PID2 control can only be used after auto-tuning has been activated and a Pid set.

Features of PID2 Control

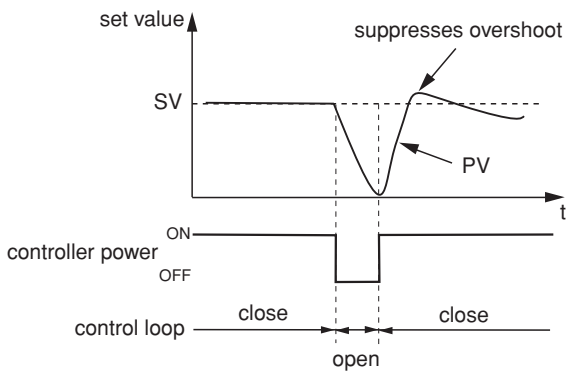

Changing to PID2 Control

- 1 Press and hold the **SEL** key to display the setup mode channel menu ("oPE Ch 1"), then use the **▲** **▼** keys to display SYS ("SYS Ch 7").

```

PV  545
SV  Ch 7
    
```

Refer to See p. 93 in this chapter for information on how to display the channel menu.

- 2 Press and hold the **SEL** key then use the **▲** **▼** keys to display CTRL ("Ctrl").

```

PV  Ctrl
SV  Pid
    
```

- 3 Press the **SEL** key, then use the **▲** **▼** keys to display "Pid2" when the bottom part of the display begins to blink.

The control method is set to "Pid2".

```

PV  Ctrl
SV  Pid2
    
```

- 4 Press the **SEL** key to confirm the setting.

- 5 Press the **A/M** key to return to the operation mode PV/SV display.

Auto-tuning

Auto-tuning automatically calculates PID.

Select from three types of auto-tuning in the operation menu ("oPE Ch 1").

AT Parameter	Operation	Function
oFF	Stop/Finish	Stops or finishes auto-tuning
on	Normal type	Standard auto-tuning. Choose this option under normal circumstances.
Lo	Low PV type	Auto-tuning that runs at SV-10%. Use this to minimize overshoot.

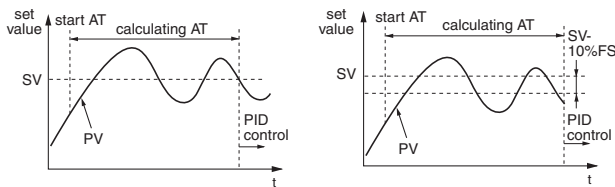

Point

- Set the following parameters before running auto-tuning.
- PV input type/ PV input upper limit/ PV input lower limit/ decimal point position on the setup channel menu ("PId Ch 5").
 - OUT1 proportion cycle (OUT2 proportion cycle) in the PID channel menu ("PId Ch 2").

Refer to



See "Auto-Tuning" for more information on Auto-Tuning. (p. 25)

- If auto-tuning has not finished after four or more hours have passed, check the following:
 - Input/output connections
 - Control output operation (normal/reverse)
 - Sensor input type
- If there are any significant changes in the operating environment, such as those below, auto-tuning must be restarted.
 - Large change in SV
 - Change in input range
 - Large change in controlled device

● Please note the following

- The PID parameters after auto-tuning has finished will be saved even if power is cut off. If power is cut off before auto-tuning is finished, PID parameters will not be changed and auto-tuning will need to be restarted.
- Control reverts to ON/OFF (2 setting) during auto-tuning, so some processes may experience large changes in PV. If you are running a process that cannot accommodate large changes in PV, do not use auto-tuning. Auto-tuning is also not suitable for processes requiring rapid response to voltage or flow controls.
- Restart auto-tuning if SV changes drastically, PV input type changes or the control object conditions change. Auto-tuning can be activated even if the control type is fuzzy or PID2.

Caution

Auto-tuning is not performed in manual mode or standby mode.

PCS Control Target

This controller has three valve control functions.
Select the best function for the current application.

● Valve Control Functions

Servo control 1 (Srv1)	Controls the motorized valve opening through [OPEN], [CLOSE] connection points.
Servo control 2 (Srv2)	Controls the motorized valve opening through [OPEN], [CLOSE] connection points. The opening of the valve can be displayed by reading the open position signal from the motorized valve, but it cannot be used in control output calculations.
Position feedback (PFB) control (Pfb)	Inserts controls by adding the opening signal from the motorized valve to the control calculation results. Controls the motorized valve opening through [OPEN], [CLOSE] connection points. This control can be used when there are opening signals coming from the motorized valve.

Servo Control 1/Servo Control 2

Adjusts and controls the motorized valve opening through [OPEN], [CLOSE] connection points.

In manual mode, press the key to switch between [OPEN] and [CLOSE].

Servo control 1 and servo control 2 have the following differences.

- Servo Control 1: No valve opening display
- Servo Control 2: Has valve opening display

Neither control can be used to control the valve opening itself.

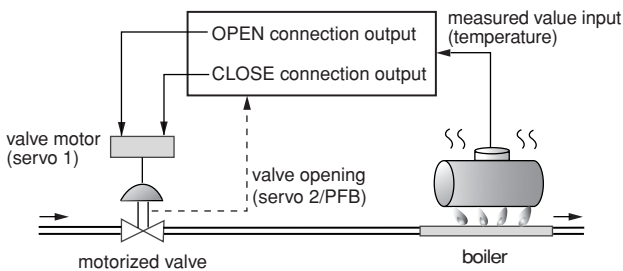

Point

- Servo control 1 can control the motorized valve even without a valve opening signal from the motorized valve. (The motorized valve opening is estimated from a calculation of the valve stroke time.)
- Servo control 2 adds the valve opening signal display function to servo control 1. Valve position display can be used to automatically or manually adjust zero/span.

Changing to Servo Control 1 or Servo Control 2

- 1 Press and hold the **SEL** key to display the setup mode channel menu ("oPE Ch 1"), then use the **▲** **▼** keys to display SYS ("SYS Ch 7").

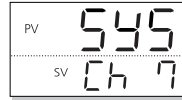

Refer to See p. 93 in this chapter for information on how to display the channel menu.

- 2 Press and hold the **SEL** key then use the **▲** **▼** keys to display CTrL ("CTrL").



- 3 Press the **SEL** key, then use the **▲** **▼** keys to select Srv1 ("Srv 1") when the bottom part of the display begins to blink.

This chooses "Servo Control 1".



- 4 Press the **SEL** key to confirm the setting.

- 5 Press the **AM** key to return to the operation mode PV/SV display.

Point

- Adjustments must be made to display the valve opening.
- See "Position feedback (PFB) control" (p. 108, 128).
- An interlock function is built in. (except for PXG4)



Caution

Chattering may occur if the dead band ("PGAP") in the PFB menu ("Pfb Ch 10") is set too small.

Setting the Valve Stroke Time



This is the procedure for setting the valve stroke time to add servo control.

The following steps explain how to set valve stroke time by using 50 seconds as an example.



- 1 Press and hold the  key to display the setup mode channel menu ("oPE Ch 1"), then use the   keys to display Pfb ("Pfb Ch 10")



Refer to See p. 93 in this chapter for information on how to display the channel menu.

- 2 Press and hold the  key then use the   keys to display TrvL ("TrvL").



- 3 Press the  key, then use the   keys to select 50 when the bottom part of the display begins to blink.

The valve stroke time is set to 50 seconds.



- 4 Press the  key to confirm the setting.



- 5 Press the  key to return to the operation mode PV/SV display.

Position Feedback Control (PFB Control)

Position feedback control (PFB) controls the position of the motorized valve based on the opening signal from the valve. In manual mode, the opening signal from the motorized valve will display as the MV value.

This method controls based on the actual valve position (opening signal), and therefore can provide a more accurate control than servo control 1 or servo control 2.

Changing to Position Feedback Control

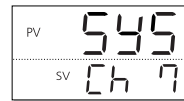

- 1 Press and hold the  key to display the setup mode channel menu ("oPE Ch 1"), then use the   keys to display SYS ("SYS Ch 7").

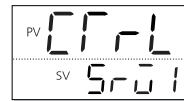

Refer to See p. 93 in this chapter for information on how to display the channel menu.

- 2 Press and hold the  key then use the   keys to display PrCS ("PrCS").



- 3 Press the  key, then use the   keys to select "Pfb" when the bottom part of the display begins to blink.

The control method is set to PFB.



- 4 Press the  key to confirm the setting.

- 5 Press the  key to return to the operation mode PV/SV display.

Refer to See "PFB Input Adjustment Command" for more about adjusting the valve opening (p. 128).

onoF HYS mode setting

Selects the hysteresis operation during two state action.

OFF: Performs two state action at SV+HYS/2 and SV-HYS/2.
ON: Performs two state action at SV, SV+HYS and SV, SV-HYS.

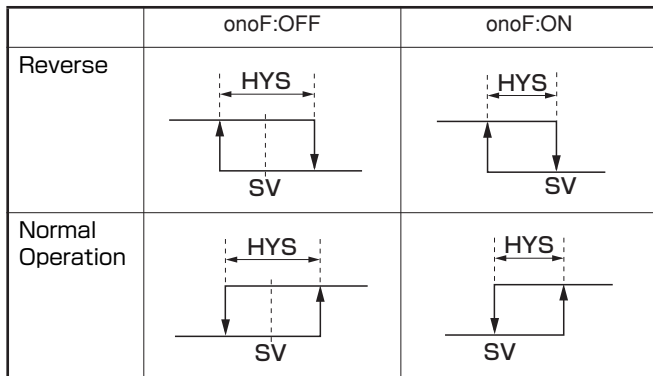

Turn on hysteresis operations.

- 1 Press and hold the **SEL** key for 3 seconds. "P" appears in the PV display area.

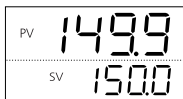

- 2 Press the **▼** key to display onoF ("onoF").



- 3 Press the **SEL** key once. The currently set value "off" flashes in the SV display area.



- 4 Press the **▼** key to display on ("on").



- 5 Press the **SEL** key once. The flashing stops and "on" is registered for hysteresis operations. The unit begins operating with the hysteresis turned on as shown in the diagram above.



- 6 To display the operation state, press and hold the **SEL** key for 2 seconds.

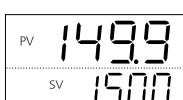

STMd Startup Mode Settings

This function specifies the mode that the device starts up in when power is supplied.

Select from the following fore options.

- Range AUto : Control output auto mode.
MAn : Control output manual mode
rEM : Remote setting value mode
STby : Standby mode

Setting the Startup Mode

The following steps explain how to set the startup mode by using control output manual mode as an example.

- 1 Press and hold the **SEL** key to display the setup mode channel menu ("oPE Ch 1"), then use the **▲** **▼** keys to display SYS ("SYS Ch 7").

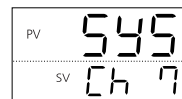

Refer to See p. 93 in this chapter for information on how to display the channel menu.

- 2 Press and hold the **SEL** key, then use the **▲** **▼** keys to display STMd ("STMd").

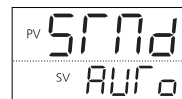

- 3 Press the **SEL** key, then use the **▲** **▼** keys to select "MAN" when the bottom part of the display begins to blink. The startup mode is set to control output manual mode.



- 4 Press the **SEL** key to confirm the setting.

- 5 Press the **A/M** key to return to the operation mode PV/SV display.

Chapter 10

Alarm Parameters (Ch8)

Overview of Alarm Parameters (Ch8) – 112

Alarm Hysteresis, Delay Time, Delay Time Units – 113

HB Alarm Set Value, HB Alarm Hysteresis – 114

Load short-circuit alarm setting Load short-circuit alarm hysteresis – 116

Loop Break Detection Time, Loop Break Detection Width – 117

Overview of Alarm Parameters (Ch8)

The Alarm Menu (Ch8) consists of the following function blocks.

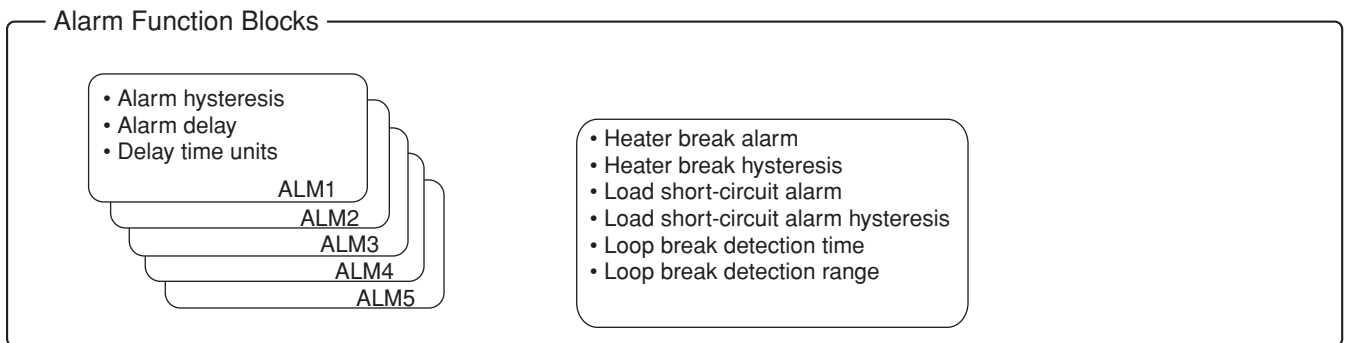

Point

- Alarm threshold values are set under ALM 1-5 on the channel menu ("oPE Eh").
- Alarm types and DO assignments are set as output event types on the system menu ("5y5 Eh").

Display	Parameter name	Function	Setting range	Initial value	Remarks	Page
"A1Hy" (A1hy)	ALM1 hysteresis	Sets the hysteresis for alarm output 1 ON/OFF	0% to 50% FS	1°C	Note 1	113
"dLY1" (dLY1)	ALM1 delay	Sets the delay before detecting alarm output 1	0 to 9999 [sec/min]	0 [sec/min]		
"dL1U" (dL1U)	ALM1 delay time units	Sets the delay time units for alarm output 1	SEC Min	Sec		
⋮	⋮	⋮	⋮	⋮		⋮
"A5Hy" (A5hy)	ALM5 hysteresis	Sets the hysteresis for alarm output 5 ON/OFF	0% to 50% FS	1°C	Note 2 Note 3	114
"dLY5" (dLY5)	ALM5 delay	Sets the delay detecting for alarm output 5	0 to 9999 [sec/min]	0 [sec/min]		
"dL5U" (dL5U)	ALM5 delay time units	Sets the delay time units for alarm output 5	SEC Min	Sec		
"hb1" (hb1)	HB alarm set value	Sets the heater break alarm detection value	0.0 to 50.0 (A)	0.0(A)	Note 2 Note 3	114
"hb1h" (hb1h)	HB alarm hysteresis	Sets the heater burnout alarm ON/OFF hysteresis	0.0 to 50.0 (A)	0.5(A)		
"hS1" (hS1)	Load short-circuit alarm setting value	Sets the heater load short-circuit alarm setting value	0.0 to 50.0A	0.0A	Note 2 Note 3	116
"hS1h" (hS1h)	Load short-circuit alarm hysteresis	Sets the heater load short-circuit alarm ON/OFF hysteresis	0.0 to 50.0A	0.5A		
"LbTM" (LbTM)	Loop break detection time	Sets the time before detecting for a broken loop	0 sec to 9999 sec	0(sec)		
"LbAb" (LbAb)	Loop break detection range (°C)	Sets the temperature range before detecting for a broken loop	0% to 100% FS	10°C		

Note 1: The displayed content changes depending on the number of points of DO or the selected alarm type.

Note 2: Displays when the seventh digit of the model code is G or J, or the eleventh digit is A.

Note 3: CT1 (LC1) is used for the parameter even if the CT2 input is used at the terminal.

Note 4: The range of parameters in the shaded area indicates the industrial values.

A1hY Alarm Hysteresis

dLY1 Delay Time

dL1U Delay Time Units

Alarm parameter settings are as follows:

Alarm Hysteresis	Specifies alarm detection and recovery width. • Range: 0% to 50% FS
Alarm Delay Time	Specifies the amount of time from the occurrence of the alarm to the sounding of the alarm. • Range: 0 to 9999(sec/min)
Alarm Delay Time Units	Specifies the unit of time (sec/min) used to measure the alarm delay • Range: sec/min

The alarm and hysteresis are related as follows.

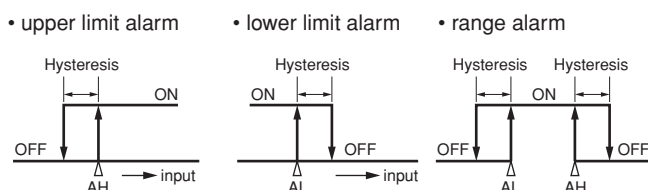
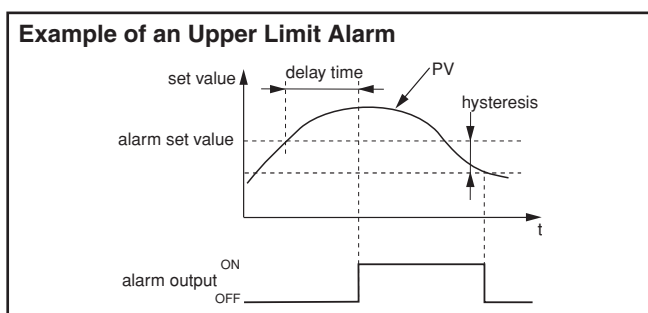

Adjusting the Settings

The following steps explain how to set alarm settings by using hysteresis = 5°C, delay = 30 sec and delay time unit = seconds as an example.

Operation mode

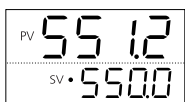

- Press and hold the **SEL** key to display "MV1".
The monitoring mode MV1 is displayed.

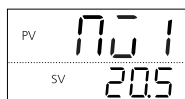

- Press and hold the **SEL** key to display the setup mode channel menu ("oPE Ch 1"), then use the **▲** **▼** keys to display ALM ("ALN Ch 8").
This sets the alarm menu.

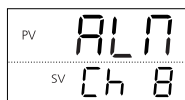

- Press and hold the **SEL** key, then use the **▲** **▼** keys to select A1hY ("A1hY").

Set the alarm 1 hysteresis.

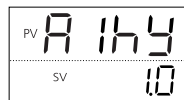

- Press the **SEL** key, then use the **▲** **▼** keys to set the hysteresis to 5.0 when the bottom part of the display begins to blink.

The value is set to 5.0°C.

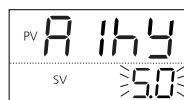

- Press the **SEL** key to confirm the setting.
The display will stop blinking.

- Use the **▲** **▼** keys to display dLY1 ("dLY1").
Set the alarm 1 delay time.

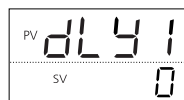

- Press the **SEL** key, then use the **▲** **▼** keys to set the alarm delay to 30 when the bottom part of the display begins to blink.

The alarm delay is set to 30 seconds.

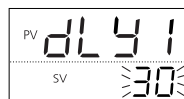

- Press the **SEL** key to confirm the setting.
The display will stop blinking.

- Use the **▲** **▼** keys to display dL1U ("dL1U").
Set the alarm 1 delay time unit.

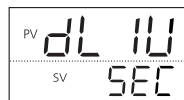

- Press the **SEL** key, then use the **▲** **▼** keys to select "SEC" when the bottom part of the display begins to blink.

The alarm 1 delay time unit is set to seconds.

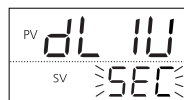

- Press the **SEL** key to confirm the setting.

- Press the **AIM** key to return to the operation mode PV/SV display.

hb 1 HB Alarm Set Value

hb 1h HB Alarm Hysteresis

This function controls whether the heater break alarm is active. It is only available during ON/OFF (2 state) control.

The heater break alarm includes the following settings:

Heater break Alarm Settings	The electric current set value at which the alarm trips. • Range: 0.0A to 50.0A
Heater break alarm hysteresis	The detection and recovery width of the heater break alarm hysteresis. • Range: 0.0A to 50.0A

The following connection diagram includes CT connections.

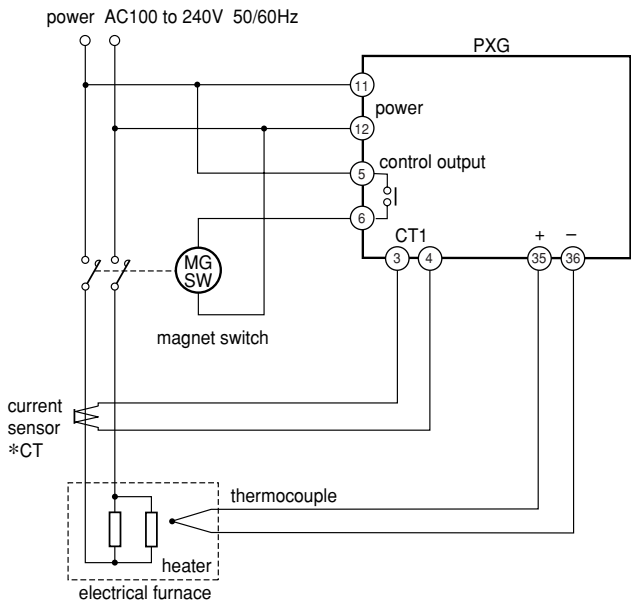

Point

- This is not used when the heater is controlled by thyristor phase angle control.
- When the margin of error is large due to low heater capacity, the problem is resolved by doubling the current to increase the sensitivity. (Be sure to double the setting value in such cases.)
- If there are multiple CTs, make sure to use the same procedure for each of them.

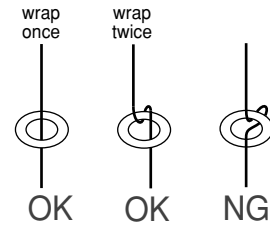

- The heater break detector CT is connected as shown below:

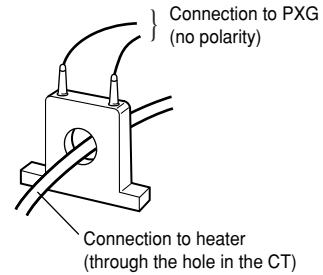

- The parameters to be set are "Hb 1" and "Hb 1h" for the CT1 or CT2 terminal that is used.
- The heater break alarm is effective only for a single-phase power supply. It cannot be used for a three-phase power supply.

The relationship between the heater disconnect alarm settings and hysteresis is shown below.

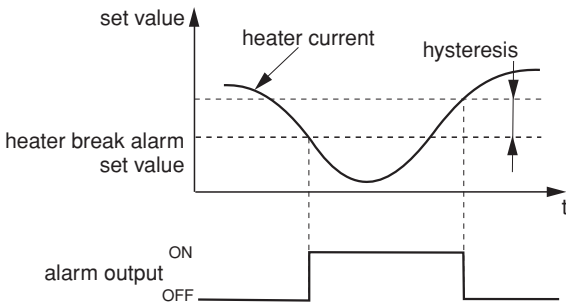

Setting Heater Break Alarm Points

The following steps explain how to set alarm activation points by using heater break alarm = 5A and hysteresis = 2A as an example.

- 1** Press and hold the **SEL** key to switch from the PV display to Manual Mode.

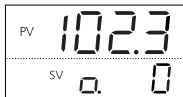

- 2** Use the **▲** keys to set control output to 100%.



- 3** Display the setup mode channel menu ("oPE Ch"), then use the **▲** **▼** keys to display Mon ("Mon Ch 5").

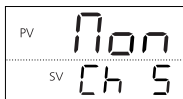

Refer to



- See p. 113 in this chapter for information on how to display the channel menu.
- See "USER Key Assignments" for more about setting the USER key (p. 93).

- 4** Press and hold the **SEL** key to display the state parameter ("STAF"), then use the **▲** **▼** keys to display CT1 ("CT 1").

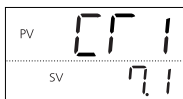

- 5** Reads the current through CT1.
The heater break alarm threshold is set to 70-80% of the electric current.

- 6** Display the setup mode channel menu ("oPE Ch"), then use the **▲** **▼** keys to display ALM ("ALM Ch 8").

- 7** Press and hold the **SEL** key to display alarm 1 hysteresis ("R hY"), then use the **▲** **▼** keys to display heater break alarm threshold 1 ("hb 1").

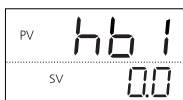

- 8** Press the **SEL** key, then use the **▲** **▼** keys to select 5.0 when the bottom part of the display begins to blink.

The heater break alarm threshold is set to 5.0A.



- 9** Press the **SEL** key to confirm the setting.
The display will stop blinking.

- 10** Use the **▲** **▼** keys to display hb1h ("hb 1h").
Set the heater break alarm hysteresis.

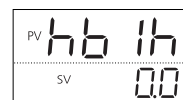

- 11** Press the **SEL** key, then use the **▲** **▼** keys to select 2.0 when the bottom part of the display begins to blink.

The heater break alarm hysteresis is set to 2.0A.

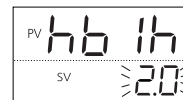

- 12** Press the **SEL** key to confirm the setting.

- 13** Press the **SEL** key to return to the operation mode PV/SV display.

The following are suitable for heater break detection devices.
1 single phase type

- For 1A to 30A: CTL-6-S-H
- For 20A to 50A: CTL-12-S36-8F

h5 1

Load short-circuit alarm setting

h5 1h

Load short-circuit alarm hysteresis

These are the functions to detect short-circuiting of the SSR or SSC. They are valid only for the ON/OFF (two positions) control.

The setting items of the load short-circuit alarm are as follows:

Load short-circuit alarm setting	Sets the electrical current value at which to detect a load short-circuit alarm. • Range: 0.0 to 50.0A
Load short-circuit alarm hysteresis	Sets the space between the detection and restoration of the load short-circuit alarm. • Range: 0.0 to 50.0A

Setting the Load Short-circuit Alarm Timing

This section describes how to set the load short-circuit alarm setting to "4A" and the hysteresis to "1.2A".

- 1 Display the setup mode channel menu ("oPE Ch"), then use the keys to display ALM ("ALN ChB").

Refer to • See p. 113 in this chapter for information on how to display the channel menu.
• See "USER Key Assignments" for more about setting the USER key (p. 93).

- 2 Press and hold the key to display alarm hysteresis 1 ("A hY"), then use the keys to display load short-circuit alarm setting hS1 ("h5 l").

- 3 Press the key, then use the keys to set the hysteresis to "4.0" when the bottom part of the display begins to blink.

The load short-circuit alarm setting is set to "4.0A".

- 4 Press the key to confirm the setting.

- 5 Use the keys to display load short-circuit alarm hysteresis hS1h ("h5 1h").

Set the hysteresis of the load short-circuit alarm.

- 6 Press the key, then use the keys to set the hysteresis to "1.2" when the bottom part of the display begins to blink.

The load short-circuit alarm hysteresis is set to "1.2A".

- 7 Press the key to confirm the setting.

- 8 Press the key to return to the operation mode PV/SV display.

LbTn Loop Break Detection Time

LbAb Loop Break Detection Width

This function detects if the control loop is broken.
This function does not use a CT like the heater break alarm, but instead PV change when using control output to determine if the loop is broken.

The loop break detector has the following functions.

Loop break detection time	Specifies how much time must pass before the loop is determined to be broken. • Range: 0 sec to 9999 sec
Loop break detection width	Sets the temperature range before detecting for a broken loop • Range: 0.0% to 100.0% FS

Loop break detection time and width are related as follows:

Example of Loop Break Detection in Reverse Operation

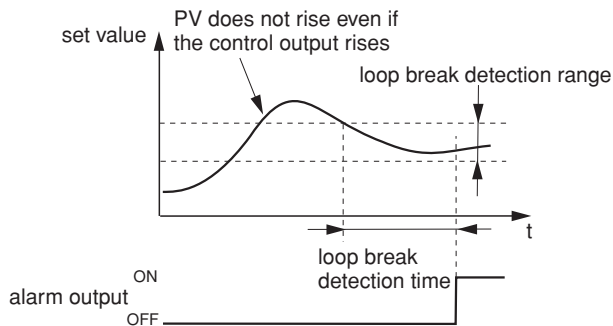

Caution

If there is an abnormal input (UUUU, LLLL) or an input setting error (Err), the loop break detection alarm sounds before even before the loop break detection time period.

Setting Loop Break Time and Width

The following steps explain how to set alarm activation by using detection time = 600 sec (10 min) and width = 20°C as an example.

- 1 Display the setup mode channel menu ("oPE Ch"), then use the keys to display ALM ("ALM ChB").
- 2 Press and hold the key to display alarm hysteresis 1 ("A hY"), then use the keys to display loop break detection time ("LbTn").

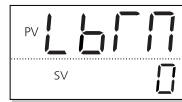

- 3 Press the key, then use the keys to select 600 when the bottom part of the display begins to blink.
The loop break detection time is set to 600 sec (10 minutes).



- 4 Press the key to confirm the setting.
- 5 Use the keys to display "LbAb" ("LbAb"). Set the loop break detection width.

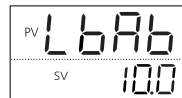

- 6 Press the key, then use the keys to select 20.0 when the bottom part of the display begins to blink.
The loop break detection width is set to 20.0°C.

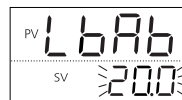

- 7 Press the key to confirm the setting.
- 8 Press the key to return to the operation mode PV/SV display.

MEMO

Chapter 11

Communication Parameters (Ch9)

Overview of Communication Parameters (Ch9) – 120

●
ST No. Setting – 122

●
Parity Setting – 122

●
Communication Permission – 123

Overview of Communication Parameters (Ch9)

This device uses an RS-485 interface and can therefore communicate with personal computers, programmable operation indicators, and other devices. These parameters set the communication conditions for sending and receiving data.

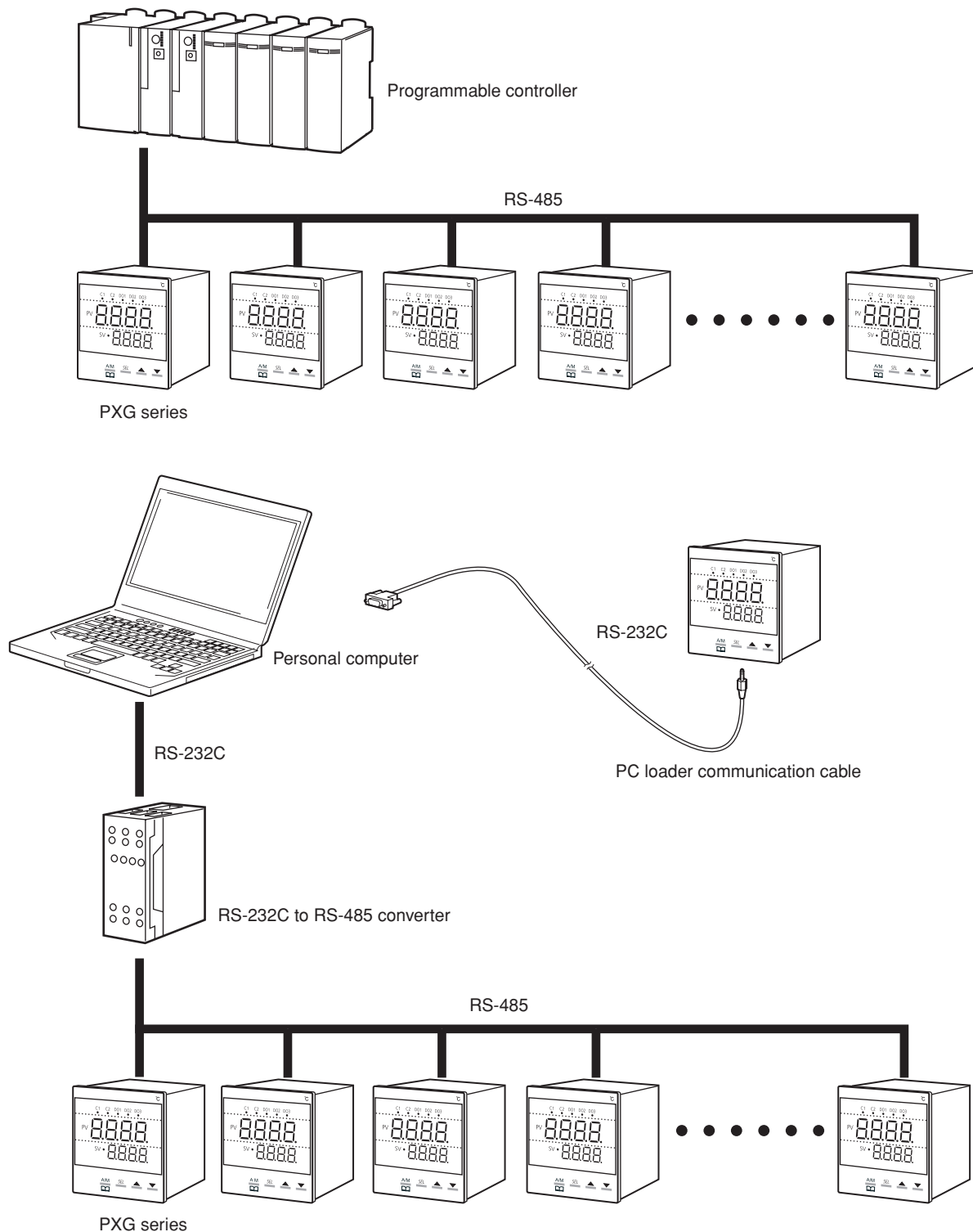

Caution

When using an RS-232C to RS-485 converter, make sure to correctly connect the cable between the converter and master. Communication will not occur properly if the connection is incorrect. Also make sure to correctly set any communication settings (such as communication speed and parity) on the RS-232C and RS-485 converter. Communication will not occur properly if the settings are incorrect.

The center of communications (personal computer, etc) on a network is called the "master". There can only be one master per network. The other devices on the network (including this device) are called "slaves" (1: N connection communication). Set a station number for each slave so that they do not overlap with each other. Communication consists of the master sending out a message with a station number attached and each slave determining if the message is meant for it. The slave to which the message was sent then responds to the master. Slaves do not initiate communication.

A network consists of 1 master and up to 31 slaves (including this device). A network can be up to 500m long.



See the "Micro Controller (Model: PXG) Communication Function Manual (MODBUS)" for information on communication procedures, protocols and settings:

The communication menu (Ch9) includes the following items:

Display	Parameter name	Function	Setting range	Initial value	Remarks	Reference page
"STno" (STno)	ST No. setting	This is the procedure for specifying the station number.	0 to 255 (0: unresponsive communication (MODBUS only))	1	Note1	122
"CoM" (CoM)	Baud rate/Parity settings	This is the procedure to specify communications speed and parity check.	96od (9600 bps/odd) 96ev (9600 bps/even) 96no (9600 bps/none) 19od (19200 bps/odd) 19ev (19200 bps/even) 19no (19200 bps/none)	96od	Note1 RST	122
"SCC" (SCC)	Communication permissions	This is the procedure to specify whether the master can write to the slave or not.	r (read only) rW (read and write)	rW	Note1	123

Note 1: Displays when the seventh digit of the model code is M, V, K, J, U or F.

ST No. Setting

This is the procedure for specifying the station number.

- Range: 0 to 255
(Note that setting the station number to 0 will suspend communication.)

Point If there are two or more slave devices, make sure that they do not have the same station numbers. If two devices on the same network share a station number, communication becomes impossible.

Setting the Station Number

The following steps explain how to set the station number by using "3" as an example.

Operation mode

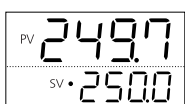

- 1 Press and hold the **SEL** key to display "NO 1".
MV1 of the monitoring mode is displayed.

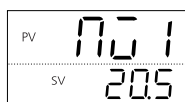

- 2 Press and hold the **SEL** key to display the setup mode channel menu ("OPF Ch 1"), then use the **▲** **▼** keys to display "Con Ch 9".
The communication menu is displayed.

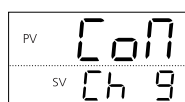

- 3 Press and hold the **SEL** key, then use the **▲** **▼** keys to display "ST No".
The station number is displayed.

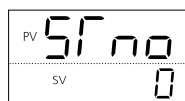

- 4 Press the **SEL** key, then use the **▲** **▼** keys to set station number to "3" when the bottom part of the display begins to blink.
The station number is set to "3".

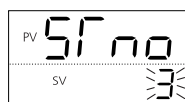

- 5 Press the **SEL** key to confirm the setting.

- 6 Press the **A/M** key to return to the operation mode PV/SV display.

Con Parity Setting

This is the procedure to specify communications speed and parity check.

- Setting range
Communications speed: 9600 bps, 19200 bps
Parity check: odd, even, none

The combinations of the items above are referred to by the following names.

- 96od (9600 bps/odd)
- 96ev (9600 bps/even)
- 96no (9600 bps/none)
- 19od (19200 bps/odd)
- 19ev (19200 bps/even)
- 19no (19200 bps/none)

Point The master and all slaves on the same network must be set to the same parity check and communications speed or communication will not be possible. The equipment cannot communicate if the settings are different.

Setting Communications Speed and Parity Check

- 1 Press and hold the **SEL** key to display the setup mode channel menu ("OPF Ch 1"), then use the **▲** **▼** keys to display the communication menu ("Con Ch 9").

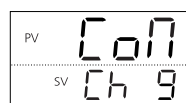

Refer to See this page for information on how to display the channel menu.

- 2 Press and hold the **SEL** key to display communication parameters ("ST No"), then use the **▲** **▼** keys to select the parity setting ("Con").

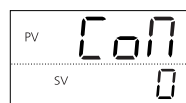

- 3 Press the **SEL** key, then use the **▲** **▼** keys to set the parity setting to "96no" when the bottom part of the display begins to blink.
The parity setting is set to "9600 bps/none".



- 4 Press the **SEL** key to confirm the setting.



- 5 Press the **A/M** key to return to the operation mode PV/SV display.

SCC Communication Permission

This is the procedure to specify whether the master is permitted or forbidden to write to the slave.



- Range r (Read only)
rW (Read/write)

Setting Communication Permission



- 1 Press and hold the  key to display the setup mode channel menu ("oPE Ch 1"), then use the   keys to display the communication menu ("Con Ch 9").

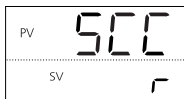

 **Refer to** See p. 122 in this chapter for information on how to display the channel menu.

- 2 Press and hold the  key to display the communication parameters ("Sfno"), then use the   keys to display communication permission ("SCC").



- 3 Press the  key, then use the   keys to set the protocol to "rW" when the bottom part of the display begins to blink.
"Read/write" is selected.

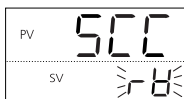

- 4 Press the  key to confirm the setting.

- 5 Press the  key to return to the operation mode PV/SV display.

MEMO

Chapter 12

Position Feedback Parameters (PFB, Ch10)

Overview of Position Feedback Parameters (PFB, Ch10) – 126

PFB Dead Band – 127

Valve Stroke Time – 127

PFB Input Adjustment Command – 128

Overview of Position Feedback Parameters (PFB, Ch10)

PFB parameters are the settings that control the motorized valve.

Display	Parameter name	Function	Setting range	Initial value	Remarks	Reference Page
"PGAP" (PGAP)	PFB dead band	Sets PFB dead band	0.0% to 100.0%	5%	Note 1	127
"TrVL" (TrVL)	Valve Stroke Time	Sets the stroke time for the motorized valve	5 sec to 180 sec	30 sec	Note 1	127
"CAL" (CAL)	PFB Input Adjustment Command	Adjusts the zero/span for PFB input	0 (none/forcibly terminate) 1 (zero adjustment) 2 (span adjustment) 3 (automatic adjustment)	–	Note 2	128

Note 1: Displays when the fifth digit of the model code is V or S.

Note 2: Displays when the fifth digit of the model code is V.

PGAP PFB Dead Band

The dead band can be set to not output the valve open or close signal.

Using the valve dead band suppresses the motorized valve hatching and allows greater stabilization of the output.

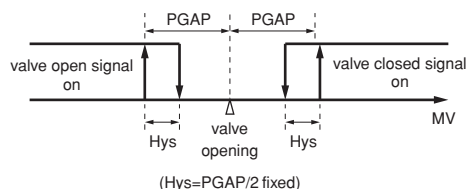

- Range: 0.0% to 100.0%

Setting Valve Stroke Time

This section explains how to set PFB dead band by using 10.0% as an example.

Operation mode



- 1 Press and hold the **SEL** key to display "MV1". The MV1 of the monitoring mode will appear.

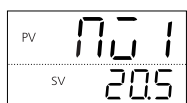

- 2 Press and hold the **SEL** key to display the setup mode channel menu ("oPE Ch 1") and use the **▲** **▼** keys to display Pfb ("PFb Ch 10").

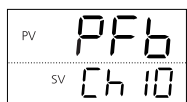

- 3 Press and hold the **SEL** key, then use the **▲** **▼** keys to display PGAP ("PGAP").

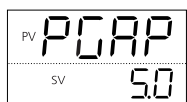

- 4 Press the **SEL** key, then use the **▲** **▼** keys to select 10.0 when the bottom part of the display begins to blink.



- 5 Press the **SEL** key to confirm the setting.

- 6 Press the **AIM** key to return to the operation mode PV/SV display.

TrVL Valve Stroke Time

This function controls the time it takes for the motorized valve to go from fully open to fully closed.

Refer to the motorized valve maker's catalog for the correct stroke time.

- Range: 5 sec to 180 sec

Setting the Valve Stroke Time

The following steps explain how to set valve stroke time by using 50 seconds as an example.

- 1 Press and hold the **SEL** key to display the setup mode channel menu ("oPE Ch 1") and use the **▲** **▼** keys to display Pfb ("PFb Ch 10").

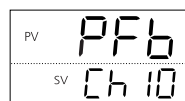

- 2 Press and hold the **SEL** key then use the **▲** **▼** keys to display TrvL ("TrVL").

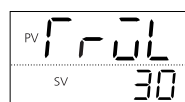

Refer to See this page for information on how to display the channel menu.

- 3 Press the **SEL** key, then use the **▲** **▼** keys to select 50 when the bottom part of the display begins to blink.

The motorized valve stroke time is set to 50 sec.

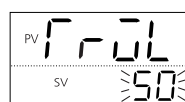

- 4 Press the **SEL** key to confirm the setting.

- 5 Press the **AIM** key to return to the operation mode PV/SV display.

Point Automatically adjusting the PFB input also automatically sets the valve stroke time.

CAL PFB Input Adjustment Command

This function adjusts whether PFB input is zero (fully closed) or span (fully opened). There are automatic and manual methods for adjusting.

Setting	Function	Explanation
0	None/forcible termination	Ends adjustment immediately
1	Zero adjustment	Manually adjust zero
2	Span adjustment	Manually adjust span
3	Automatic adjustment	Automatically adjusts zero/span

Making Adjustments Manually

This section explains how to make motorized valve adjustments manually.

Operation mode

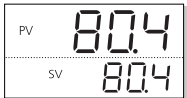

1 Switch the unit to manual mode.

Refer to See "Auto/Manual Switch" for more about switching to manual mode (p. 23).

2 Press and hold the **SEL** key to switch to manual mode, then press the **▼** key to fully close the motorized valve.

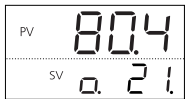

3 Press and hold the **SEL** key to display the setup mode channel menu ("oPE Ch 1") and use the **▲** **▼** keys to display PFB ("PFb Ch 10").

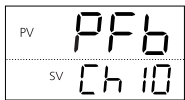

Refer to See p. 127 in this chapter for information on how to display the channel menu.

4 Press and hold the **SEL** key, then use the **▲** **▼** keys to select CAL ("CAL").

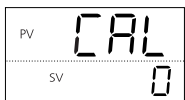

5 Press the **SEL** key, then use the **▲** **▼** keys to select 1 when the bottom part of the display begins to blink.

When "1" automatically changes back to "0", the zero adjustment is finished.

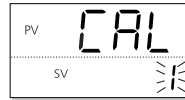

6 Press the **A/M** key to return to the operation mode PV/SV display.

7 Press and hold the **SEL** key to switch to manual mode, then press the **▲** key to fully open the motorized valve.

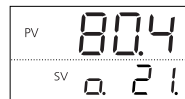

8 Press and hold the **SEL** key to display the setup mode channel menu ("oPE Ch 1") and use the **▲** **▼** keys to display PFB ("PFb Ch 10").

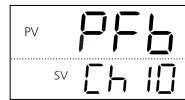

Refer to See p. 127 in this chapter for information on how to display the channel menu.

9 Press and hold the **SEL** key, then use the **▲** **▼** keys to select CAL ("CAL").

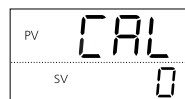

10 Press the **SEL** key, then use the **▲** **▼** keys to select 2 when the bottom part of the display begins to blink.

When "2" automatically changes back to "0", the span adjustment is finished.

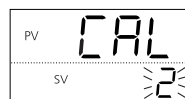

11 Press the **A/M** key to return to the operation mode PV/SV display.

Caution Manual adjustment must be set in the order zero (fully closed), then span (fully open). Adjustments cannot be made on just zero or just span.

Making Adjustments Automatically

The following steps explain how to make adjustments to zero and span automatically.

Operation mode



1 Switch the unit to manual mode.

Refer to See "Auto/Manual Switch" for more about switching to manual mode (p. 23).

2 Press and hold the **SEL** key to display the setup mode channel menu ("oPE Ch 1") and use the **▲** **▼** keys to display PFB ("PFb Ch 10").

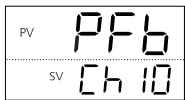

Refer to See p. 127 in this chapter for information on how to display the channel menu.

3 Press and hold the **SEL** key, then use the **▲** **▼** keys to select CAL ("CAL").

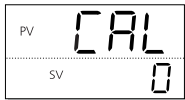

4 Press the **SEL** key, then use the **▲** **▼** keys to select 3 when the bottom part of the display begins to blink.

The motorized valve will automatically move from fully open to fully closed and record those positions.

When "3" automatically changes back to "0", the adjustment is finished.

Automatic adjustment has failed if "10" or "20" are displayed.

(10: Over travel time

20: PFB span error)

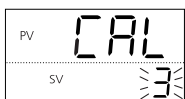

5 Press the **A/M** key to return to the operation mode PV/SV display.

Caution Switch the unit to manual mode to automatically adjust PFB input. The adjustment can only take place in manual mode.

Point When running automatic adjustment with "CAL" at "3", an adjustment error has occurred if the display changes to "10" or "20". Remove the source of the error and perform adjustment again.

CAL display	Error name	Error source	Measures against error
10	Over travel time	Automatic adjustment does not finish within 180 seconds.	The full stroke time greater than 180 seconds cannot be used for the motorized valve. Use a full stroke time within 180 seconds for the motorized valve.
20	PFB span error	There is an error in the span value for PFB input.	Recheck the valve control output and PFB input wire connection.

MEMO

Chapter 13

Password Setup (Ch11)

Overview of Password Setup (Ch11) – 132

●
Passwords 1 to 3 – 132

Overview of Password Setup (Ch11)

The password function allows you to hide displays by block (multiple channels).

Blocks set not to display can be changed by entering monitoring mode and inputting the password (PASS) to display the channels included in those blocks.

Refer to  See "Monitor Mode" (p. 13) for more information about entering passwords

There are five types of password settings: "PAS1", "PAS2", "PAS3", "Super PASS", and "Special PASS".

Channel Menu			Password				
Channel	Display	Contents	PAS1	PAS2	PAS3	Super PASS	Special PASS
Ch1	"oPE"	Operation Parameters	●	●	●	●	●
Ch2	"PId"	Control (PID) Parameters	●	●	●	●	●
Ch3	"PLF"	PID Palette Parameters	×	●	●	●	●
Ch4	"PrG"	Ramp/Soak Parameters	×	●	●	●	●
Ch5	"Mon"	Monitor Parameters	×	×	●	●	●
Ch6	"SEt"	Setup Parameters	×	×	●	●	●
Ch7	"SYS"	System Parameters	×	×	●	●	●
Ch8	"ALN"	Alarm Parameters	×	×	●	●	●
Ch9	"CoM"	Communication Parameters	×	×	●	●	●
Ch10	"PFb"	PositionFeedback Parameters	×	×	●	●	●
Ch11	"PAS"	Password Setup	×	×	●	●	●
Ch12	"dSP"	Display Mask for Each Parameters	×	×	●	●	●
Ch13	"CFG"	Environmental Parameters	×	×	×	×	●

- : Displayed when the password is entered.
- × : Not displayed, even when the password is entered.

Point

The channel menu will not appear if the display mask function is set to not display. However, dSP (Ch12) will always appear when Super PASS or Special PASS are entered.

Refer to  See Chapter 14 "Display Mask for Each Parameter (Ch12)" (page 133) for an explanation of the display mask function.

Factory settings for passwords are as follows:

Password Type	PAS1	PAS2	PAS3	Super PASS	Special PASS
Password	0000	0000	0000	FEFE	F1C0

Caution

Special PASS or Super PASS passwords cannot be changed. Enter the above passwords to display channel 13 (config) to set parameters.

PAS1 to PAS3

Passwords 1 to 3

This section explains how to set passwords.

Range: 0000 to FFFF

Steps for Setting the Password

The following steps explain how to set passwords by using PAS2 = 1234 as an example.

Operation mode



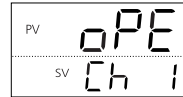

- 1 Press and hold the  key to display the setup mode channel menu ("oPE Ch 1").







Refer to  See page 127 for information on how to display the channel menu.

- 2 Use the   keys to select channel 11 ("PAS Ch 11").



- 3 Press and hold the  key. "PAS 1" will appear in the upper part of the display. Use the   keys to select "PAS2".



- 4 Press the  key, then use the   keys to set "1234", and press the  key to confirm the setting.



- 5 Press the  key to return to the operation mode PV/SV display.

Chapter 14

Display Mask for Each Parameter (Ch12)

Overview of Display Mask (Ch12) – 134

●
Display Parameters 1 to 30 – 139

Overview of Display Mask (Ch12)

Use the display mask function to hide parameters and skip parameter display.

This function is useful for hiding unused parameters or to skip parameters and protect them from accidental change.

Use the dP No. and bit position in the following table to set hidden parameters.

Point

- The value of the bit position for parameters set to hidden is 1.
- Add the binary number (Bin) for each bit and set the value converted into a hexadecimal value.
- When the value for dP30 bit position 15 is 1, all of the parameters are forcibly displayed.

Refer to



See p. 138 in this chapter for an example of the settings.

Display Screen or Channel	Parameter	dP	
		No.	Bit position
Operating Screen	$P\bar{U}$	dP30	14
	$S\bar{U}$	dP30	13
Monitoring Screen	$FRL\bar{F}$	dP28	0
	$\bar{N}\bar{U}1$	dP28	1
	$\bar{N}\bar{U}2$	dP28	2
	$PF\bar{b}$	dP28	3
	$rS\bar{U}$	dP28	4
	$PR\bar{S}\bar{S}$	dP28	–
Channel Display Screen	$oP\bar{E}r$	dP29	0
	$P\bar{C}d$	dP29	1
	$PL\bar{F}$	dP29	2
	$P\bar{r}\bar{G}$	dP29	3
	$\bar{N}on$	dP29	4
	$SE\bar{F}$	dP29	5
	$S\bar{Y}\bar{S}$	dP29	6
	$RL\bar{N}$	dP29	7
	$\bar{C}o\bar{N}$	dP29	8
	$PF\bar{b}$	dP29	9
	$PR\bar{S}$	dP29	10
	dSP	dP29	11
	$\bar{C}F\bar{G}$	dP29	12

Display Screen or Channel	Parameter	dP	
		No.	Bit position
Operation Ch 1	$\bar{N}Rn$	dP01	0
	$S\bar{r}b\bar{Y}$	dP01	1
	rER	dP01	2
	$P\bar{r}\bar{G}$	dP01	3
	$R\bar{F}$	dP01	4
	$LRC\bar{h}$	dP01	5
	$S\bar{U}n$	dP01	6
	$PLn1$	dP01	7
	$RL1$	dP01	8
	$RL1L$	dP01	9
	$RL1h$	dP01	10
	$RL2$	dP01	11
	$RL2L$	dP01	12
	$RL2h$	dP01	13
	$RL3$	dP01	14
	$RL3L$	dP01	15
	$RL3h$	dP02	0
	$RL4$	dP02	1
	$RL4L$	dP02	2
	$RL4h$	dP02	3
$RL5$	dP02	4	
$RL5L$	dP02	5	
$RL5h$	dP02	6	
$L\bar{o}\bar{C}$	dP02	7	
PID Ch 2	P	dP03	0
	\bar{I}	dP03	1
	d	dP03	2
	$h\bar{Y}\bar{S}$	dP03	3
	$\bar{C}oL$	dP03	4
	db	dP03	5
	bRL	dP03	6
	Rr	dP03	7
	$rE\bar{U}$	dP03	8
	$S\bar{U}L$	dP03	9
	$S\bar{U}h$	dP03	10
	$FL1$	dP03	11
	$FL2$	dP03	12
	$PLC1$	dP03	13
	$PhC1$	dP03	14
	$PLC2$	dP03	15
	$PhC2$	dP04	0
	$PCUR$	dP04	1
	$EN\bar{U}1$	dP04	2
	$EN\bar{U}2$	dP04	3
	$PN\bar{U}$	dP04	4
	$PN\bar{U}1$	dP04	5
	$PN\bar{U}2$	dP04	6

Display Screen or Channel	Parameter	dP	
		No.	Bit position
PID palette Ch 3	<i>S01</i>	dP05	0
	<i>P1</i>	dP05	1
	<i>L1</i>	dP05	2
	<i>d1</i>	dP05	3
	<i>hY51</i>	dP05	4
	<i>Col1</i>	dP05	5
	<i>db1</i>	dP05	6
	<i>bAL1</i>	dP05	7
	<i>Rr1</i>	dP05	8
	<i>rE01</i>	dP05	9
	<i>S02</i>	dP05	10
	<i>P2</i>	dP05	11
	<i>L2</i>	dP05	12
	<i>d2</i>	dP05	13
	<i>hY52</i>	dP05	14
	<i>Col2</i>	dP05	15
	<i>db2</i>	dP06	0
	<i>bAL2</i>	dP06	1
	<i>Rr2</i>	dP06	2
	<i>rE02</i>	dP06	3
	<i>S03</i>	dP06	4
	<i>P3</i>	dP06	5
	<i>L3</i>	dP06	6
	<i>d3</i>	dP06	7
	<i>hY53</i>	dP06	8
	<i>Col3</i>	dP06	9
	<i>db3</i>	dP06	10
	<i>bAL3</i>	dP06	11
	<i>Rr3</i>	dP06	12
	<i>rE03</i>	dP06	13
	<i>S04</i>	dP06	14
	<i>P4</i>	dP06	15
	<i>L4</i>	dP07	0
	<i>d4</i>	dP07	1
	<i>hY54</i>	dP07	2
	<i>Col4</i>	dP07	3
	<i>db4</i>	dP07	4
	<i>bAL4</i>	dP07	5
	<i>Rr4</i>	dP07	6
	<i>rE04</i>	dP07	7
	<i>S05</i>	dP07	8
	<i>P5</i>	dP07	9
	<i>L5</i>	dP07	10
	<i>d5</i>	dP07	11
	<i>hY55</i>	dP07	12
<i>Col5</i>	dP07	13	
<i>db5</i>	dP07	14	

Display Screen or Channel	Parameter	dP	
		No.	Bit position
PID palette Ch 3	<i>bAL5</i>	dP07	15
	<i>Rr5</i>	dP08	0
	<i>rE05</i>	dP08	1
	<i>S06</i>	dP08	2
	<i>P6</i>	dP08	3
	<i>L6</i>	dP08	4
	<i>d6</i>	dP08	5
	<i>hY56</i>	dP08	6
	<i>Col6</i>	dP08	7
	<i>db6</i>	dP08	8
	<i>bAL6</i>	dP08	9
	<i>Rr6</i>	dP08	10
	<i>rE06</i>	dP08	11
	<i>S07</i>	dP08	12
	<i>P7</i>	dP08	13
	<i>L7</i>	dP08	14
	<i>d7</i>	dP08	15
	<i>hY57</i>	dP09	0
	<i>Col7</i>	dP09	1
	<i>db7</i>	dP09	2
<i>bAL7</i>	dP09	3	
<i>Rr7</i>	dP09	4	
<i>rE07</i>	dP09	5	
<i>S08H</i>	dP10	0	
<i>PL in</i>	dP10	1	

Display Screen or Channel	Parameter	dP	
		No.	Bit position
Ramp/Soak Ch 4	<i>Prn</i>	dP11	0
	<i>FCNU</i>	dP11	1
	<i>SU-1</i>	dP11	2
	<i>FN1r</i>	dP11	3
	<i>FN1S</i>	dP11	4
	<i>SU-2</i>	dP11	5
	<i>FN2r</i>	dP11	6
	<i>FN2S</i>	dP11	7
	<i>SU-3</i>	dP11	8
	<i>FN3r</i>	dP11	9
	<i>FN3S</i>	dP11	10
	<i>SU-4</i>	dP11	11
	<i>FN4r</i>	dP11	12
	<i>FN4S</i>	dP11	13
	<i>SU-5</i>	dP11	14
	<i>FN5r</i>	dP11	15
	<i>FN5S</i>	dP12	0
	<i>SU-6</i>	dP12	1
	<i>FN6r</i>	dP12	2
	<i>FN6S</i>	dP12	3
	<i>SU-7</i>	dP12	4
	<i>FN7r</i>	dP12	5
	<i>FN7S</i>	dP12	6
	<i>SU-8</i>	dP12	7
	<i>FN8r</i>	dP12	8
	<i>FN8S</i>	dP12	9
	<i>SU-9</i>	dP12	10
	<i>FN9r</i>	dP12	11
	<i>FN9S</i>	dP12	12
	<i>SU-10</i>	dP12	13
	<i>FN10r</i>	dP12	14
	<i>FN10S</i>	dP12	15
	<i>SU-11</i>	dP13	0
	<i>FN11r</i>	dP13	1
	<i>FN11S</i>	dP13	2
	<i>SU-12</i>	dP13	3
	<i>FN12r</i>	dP13	4
	<i>FN12S</i>	dP13	5
	<i>SU-13</i>	dP13	6
	<i>FN13r</i>	dP13	7
	<i>FN13S</i>	dP13	8
	<i>SU-14</i>	dP13	9
	<i>FN14r</i>	dP13	10
	<i>FN14S</i>	dP13	11
	<i>SU-15</i>	dP13	12
<i>FN15r</i>	dP13	13	
<i>FN15S</i>	dP13	14	

Display Screen or Channel	Parameter	dP	
		No.	Bit position
Ramp/Soak Ch 4	<i>SU-16</i>	dP13	15
	<i>FN16r</i>	dP14	0
	<i>FN16S</i>	dP14	1
	<i>Mod</i>	dP14	2
	<i>USoak</i>	dP14	3
	<i>US-L</i>	dP14	4
	<i>US-h</i>	dP14	5
	<i>PUSF</i>	dP14	6
	<i>CoF</i>	dP14	7
	<i>PrnN</i>	dP14	8
	<i>PNLn</i>	dP14	9
Monitor Ch 5	<i>SRAF</i>	dP15	0
	<i>NU-1</i>	dP15	1
	<i>NU-2</i>	dP15	2
	<i>PFb</i>	dP15	3
	<i>rSU</i>	dP15	4
	<i>CF-1</i>	dP15	5
	<i>LC-1</i>	dP15	7
	<i>FN-1</i>	dP15	9
	<i>FN-2</i>	dP15	10
	<i>FN-3</i>	dP15	11
	<i>FN-4</i>	dP15	12
	<i>FN-5</i>	dP15	13
	<i>FALF</i>	dP15	14
	<i>PLno</i>	dP15	15
	<i>Prno</i>	dP16	0

Display Screen or Channel	Parameter	dP	
		No.	Bit position
Setup Ch 6	<i>P0F</i>	dP17	0
	<i>P0b</i>	dP17	1
	<i>P0F</i>	dP17	2
	<i>P0d</i>	dP17	3
	<i>P0U</i>	dP17	4
	<i>C0F</i>	dP17	5
	<i>P0oF</i>	dP17	6
	<i>S0oF</i>	dP17	7
	<i>FF</i>	dP17	8
	<i>RdJ0</i>	dP17	9
	<i>RdJ5</i>	dP17	10
	<i>rCJ</i>	dP17	11
	<i>rEN0</i>	dP17	12
	<i>rENS</i>	dP17	13
	<i>rENr</i>	dP17	14
	<i>C1r</i>	dP18	0
	<i>C2r</i>	dP18	1
	<i>FLo1</i>	dP18	2
	<i>FLo2</i>	dP18	3
	<i>SFo1</i>	dP18	4
	<i>SFFn</i>	dP18	6
	<i>Sbo1</i>	dP18	7
	<i>Sbo2</i>	dP18	8
	<i>Sbnd</i>	dP18	9
<i>Rof</i>	dP18	10	
<i>RoL</i>	dP18	11	
<i>RoH</i>	dP18	12	

Display Screen or Channel	Parameter	dP	
		No.	Bit position
System Ch 7	<i>UEEY</i>	dP19	0
	<i>dC1</i>	dP19	1
	<i>dC2</i>	dP19	2
	<i>dC3</i>	dP19	3
	<i>dC4</i>	dP19	4
	<i>dC5</i>	dP19	5
	<i>do1f</i>	dP19	6
	<i>do2f</i>	dP19	7
	<i>do3f</i>	dP19	8
	<i>do4f</i>	dP19	9
	<i>do5f</i>	dP19	10
	<i>doP1</i>	dP19	11
	<i>doP2</i>	dP19	12
	<i>doP3</i>	dP19	13
	<i>doP4</i>	dP19	14
	<i>doP5</i>	dP19	15
	<i>rNP</i>	dP20	0
	<i>rNPL</i>	dP20	1
	<i>rNPb</i>	dP20	2
	<i>rNPU</i>	dP20	3
Alarm Ch 8	<i>S0f</i>	dP20	4
	<i>SLFb</i>	dP20	8
	<i>SFn d</i>	dP20	9
	<i>PrCS</i>	dP20	10
	<i>R1hY</i>	dP21	0
	<i>dLY1</i>	dP21	1
	<i>dL1U</i>	dP21	2
	<i>R2hY</i>	dP21	3
	<i>dLY2</i>	dP21	4
	<i>dL2U</i>	dP21	5
	<i>R3hY</i>	dP21	6
	<i>dLY3</i>	dP21	7
	<i>dL3U</i>	dP21	8
	<i>R4hY</i>	dP21	9
	<i>dLY4</i>	dP21	10
	<i>dL4U</i>	dP21	11
	<i>R5hY</i>	dP21	12
	<i>dLY5</i>	dP21	13
	<i>dL5U</i>	dP21	14
	<i>hb1</i>	dP21	15
<i>hb1h</i>	dP22	0	
<i>h51</i>	dP22	1	
<i>h51h</i>	dP22	2	
<i>LbFn</i>	dP22	7	
<i>LbAb</i>	dP22	8	

Display Screen or Channel	Parameter	dP	
		No.	Bit position
Communication Ch 9	<i>Sfno</i>	dP23	0
	<i>Con</i>	dP23	1
	<i>SCC</i>	dP23	3
PFB Ch 10	<i>PGAP</i>	dP24	0
	<i>FrUL</i>	dP24	1
	<i>CRl</i>	dP24	3
Password Ch 11	<i>PRS1</i>	dP25	0
	<i>PRS2</i>	dP25	1
	<i>PRS3</i>	dP25	2
Config Ch 13	<i>rdUF</i>	dP26	0
	<i>r-ft</i>	dP26	2
	<i>Soft</i>	dP26	3
	<i>RLNF</i>	dP26	4
	<i>L-C1</i>	dP26	6
	<i>L-C2</i>		
	<i>rSf</i>	dP26	8
	<i>bCon</i>	dP26	9
<i>Pf.nf</i>	dP26	10	

dP01 to dP30

Display Parameters 1 to 30

This section explains the procedure for hiding parameters that are not being used or that will not be changed.

Point

- Before making any changes, find the corresponding bit position for the setting parameter (dP01 to dP30) to be hidden on the parameter list in the overview of this chapter.
- The value of the bit position for parameters set to hidden is 1.
- Add the binary number (Bin) for each bit and set the value converted into a hexadecimal value.

Refer to



See "Overview of Display Mask (Ch 12)" in this chapter (p. 134).

Range: 0000 to FFFF

Steps for Setting Displayed Parameters

The following steps explain how to set PLT SV2 on Ch3 to be hidden as an example.

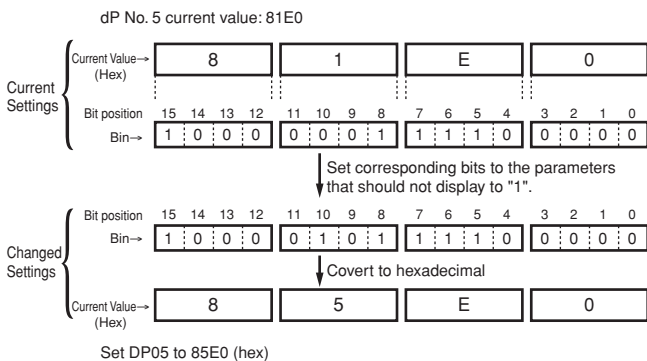

Hexadecimal and Binary Conversion Table

Hex	Bin	Hex	Bin
Hexadecimal	Binary	Hexadecimal	Binary
0	0000	9	1001
1	0001	A	1010
2	0010	B	1011
3	0011	C	1100
4	0100	D	1101
5	0101	E	1110
6	0110	F	1111
7	0111		
8	1000		

The parameters and settings to be used are as follows:

- Parameter : dP05
- Set value : 85E0

Operation mode



1 Press and hold the **SEL** key to display the setup mode channel menu ("dPE Ch 1").

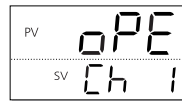

Refer to



See page 127 for information on how to display the channel menu.

2 Press the **▲** **▼** keys to select channel 12 (Top of display: "dSP").

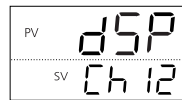

3 Press and hold the **SEL** key until "dP05" is displayed, then use the **▲** **▼** keys to select "dP05".

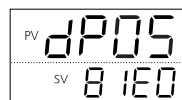

4 Press the **SEL** key so that "81E0" begins to blink, then use the **▲** **▼** keys to setting the set value. Press the **SEL** key to confirm the setting.

This sets the value "85E0".

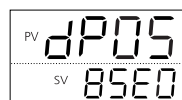

5 Press the **A/M** key to return to the operation mode PV/SV display.

MEMO

Chapter 15

Environmental Parameters (Config Ch13)

Overview of Environmental Parameters (Ch13) – 142

●
Display Timeout Settings – 143

●
Remote Blink Setting – 144

●
Soft Start Blink Setting – 144

●
ALM Blink – 145

●
Burnout Control Selection – 146

●
Ramp soak pattern order – 147

●
C2 Lamp Allocation – 148

●
Controller Reset – 149

 **Refer to** The parameters for "Config Ch13" are not displayed until the special password is set in password "PASS". For more about passwords, see "Monitor Mode" (page 13). For more about the special password, see "Password Setup" (page 132).

Overview of Environmental Parameters (Ch13)

This section covers the operating environment parameters for this device.

Display	Parameter name	Function	Setting range	Initial value	Remarks
"ToUT" (ToUT)	Display Timeout Setting	Specifies the time after which the setting display returns to the PV/SV display.	15S: 15 sec	60S	143
			30s: 30 sec		
			60s: 60 sec		
			5M: 5 min		
			10M: 10 min		
			non		
"r-Fk" (r-Fk)	Remote SV Display Blink Setting	Specifies whether the SV display blinks when in remote mode.	oFF: OFF	on	144
			on : ON		
"SoFk" (SoFk)	Soft Start SV Display Blink Settings	Specifies whether the SV display blinks during soft start.	oFF: OFF	on	144
			on : ON		
"ALMF" (ALMF)	ALM PV/SV Display Blink	Specifies whether the PV/SV display blinks when DO turns ON.	Setting display 0 to 255 (decimal)	0	145
			Setting <input checked="" type="checkbox"/> <input checked="" type="checkbox"/> <input checked="" type="checkbox"/> <input type="checkbox"/> <input type="checkbox"/> <input type="checkbox"/> (binary)		
			<ul style="list-style-type: none"> <input type="checkbox"/> 1: blinking (DO1: ON) <input type="checkbox"/> 0: no blinking <input type="checkbox"/> 1: blinking (DO2: ON) <input type="checkbox"/> 0: no blinking <input type="checkbox"/> 1: blinking (DO3: ON) <input type="checkbox"/> 0: no blinking <input type="checkbox"/> 1: blinking (DO4: ON) <input type="checkbox"/> 0: no blinking <input type="checkbox"/> 1: blinking (DO5: ON) <input type="checkbox"/> 0: no blinking 		
"bCon" (bCon)	Burnout control selection	Sets whether to maintain or stop the control when the PV input burnout is detected.	on : Continuous control oFF : Stop control	oFF	146
"PTnT" (PTnT)	Ramp soak pattern order	Changes the ramp soak pattern order.	0: (normal order) 1: (special order)	0	147
"L-C2" (L-C2)	C2 LED lamp function allocation	Sets the illumination condition of the C2 lamp.	0: MV2 output/CLOSE output (lights/blinks, but the AO output does not function.) 1: during manual mode 2: during standby 3: during remote SV mode 4: no function (do not set) 5: during soft start 6: during ramp SV 7: during ramp/soak 8: during SV selection (when other than front SV is selected) 9: during PID selection (when PID other than Pid channel is selected) 10: during auto-tuning	0	148
"rST" (rST)	Main Unit Reset	Main Unit Reset	oFF: Do nothing	oFF	149
			rST: Reset main unit		

TOUR Display Timeout Settings

This section explains how to set the time that the device waits for input before returning from monitor or setup mode (channel or parameter display) to PV/SV display.

- Range 15S : 15 sec
- 30S : 30 sec
- 60S : 60 sec
- 5M : 5 min
- 10M : 10 min
- non : Do not return

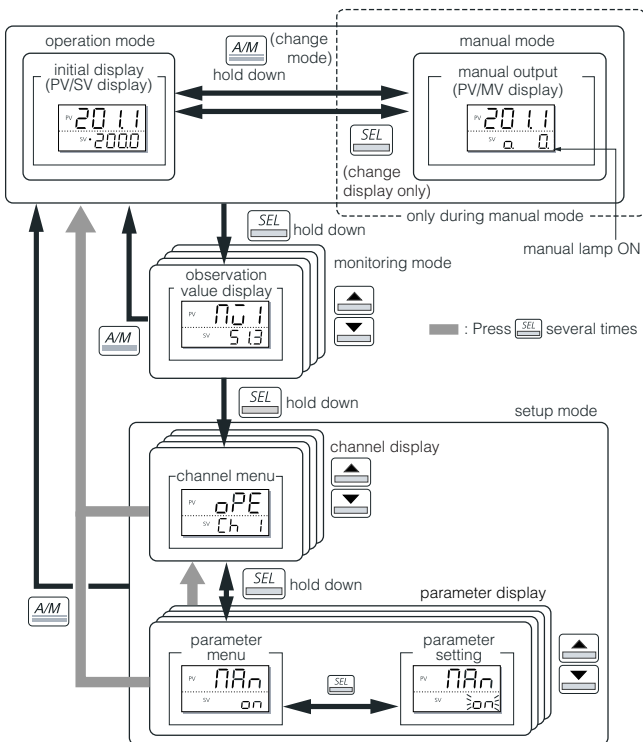

Setting the Display Timeout

This section explains how to set the display timeout by using 10 min as an example.

Operation mode



- 1 Press and hold the **SEL** key to display "nū 1".
The monitoring mode MV1 is displayed.



- 2 Press and hold the **SEL** key to display the setup mode channel menu ("oPE Ch 1"), then use the **▲** **▼** keys to display CFG ("CFG Ch 13").



- 3 Press and hold the **SEL** key, then use the **▲** **▼** keys to display ToUT ("TOUR").

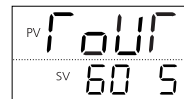

- 4 Press the **SEL** key, then use the **▲** **▼** keys to select "10M" when the bottom part of the display begins to blink.

The display timeout is set to 10 minutes.



- 5 Press the **SEL** key to confirm the setting.

- 6 Press the **A/M** key to return to the operation mode PV/SV display.

r-Fk Remote Blink Setting

This section explains how to specify whether "r5ū" blinks in the SV display when remote SV is selected.

- Range off : Displays "r5ū" value.
- on : Displays "r5ū" and SV alternately.

The display alternates between the following two states when set to "Blink."

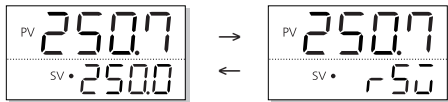

Setting the Remote SV Blink Setting

- 1 Press and hold the **SEL** key to display the setup mode channel menu ("oPE [h l]), then use the **▲** **▼** keys to display CFG ("CFG [h l3]").



Refer to See p. 143 in this chapter for information on how to display the channel menu.

- 2 Press and hold the **SEL** key, then use the **▲** **▼** keys to select r-Fk ("r-Fk").

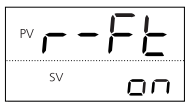

- 3 Press the **SEL** key, then use the **▲** **▼** keys to select "oFF" when the bottom part of the display begins to blink.

The remote blink setting is set to off.

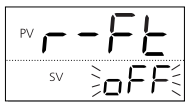

- 4 Press the **SEL** key to confirm the setting.

- 5 Press the **AM** key to return to the operation mode PV/SV display.

Soft Soft Start Blink Setting

This section explains how to specify whether "Soft" blinks in the SV display when using soft start.

- Range off : Does not display "Soft" and SV alternately.
- on : Displays "Soft" and SV alternately.

The display alternates between the following two states when set to "Blink."

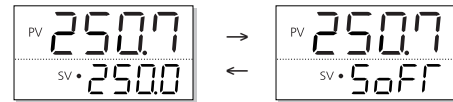

Setting the Soft Start Blink Setting

- 1 Press and hold the **SEL** key to display the setup mode channel menu ("oPE [h l]), then use the **▲** **▼** keys to display CFG ("CFG [h l3]").

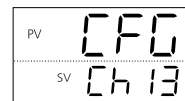

Refer to See p. 143 in this chapter for information on how to display the channel menu.

- 2 Press and hold the **SEL** key, then use the **▲** **▼** keys to display "Soft".

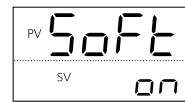

- 3 Press the **SEL** key, then use the **▲** **▼** keys to select "oFF" when the bottom part of the display begins to blink.

The soft start blink setting is set to off.



- 4 Press the **SEL** key to confirm the setting.

- 5 Press the **AM** key to return to the operation mode PV/SV display.

ALMF ALM Blink

This section explains how to specify whether the operation mode (PV/SV display) blinks when an alarm occurs.

Setting display 0 to 255 (decimal)

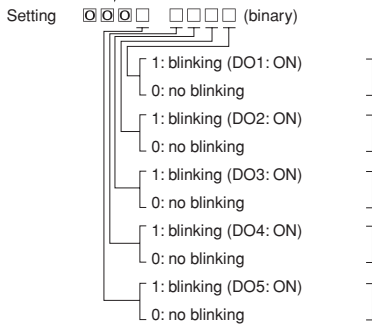



4 Press the  key to confirm the setting.

5 Press the  key to return to the operation mode PV/SV display.



Setting ALM Blink

The following steps explain how to set the PV/SV display to blink when ALM1 (DO1), ALM2 (DO2), or ALM3 (DO3) occurs (ON) as an example.

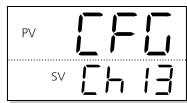

1 Press and hold the  key to display the setup mode channel menu ("oPE Ch 1"), then use the   keys to display CFG ("CFG Ch 13").

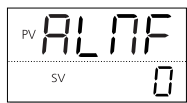

Refer to See p. 143 in this chapter for information on how to display the channel menu.

2 Press and hold the  key, then use the   keys to select ALMF ("ALMF").



3 Press the  key, then use the   keys to select 7 when the bottom part of the display begins to blink.

The setting is as follows because the PV/SV display blinks when ALM1 (DO1), ALM2 (DO2), or ALM3 (DO3) occurs.

Binary number: 0000 0111



Decimal number: 7

Therefore, set "7" here.

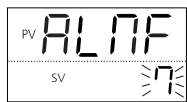

bCon Burnout Control Selection

Sets whether to maintain or stop the control when the PV input burnout is detected.



- Setting range on: Continuous control
off: Stop control (control output depends on the set values of FL01 and FL02.)

Caution

When [maintain control] is selected in the burnout control selection, PID calculation is performed with the burned-out PV value and the preset SV value. Use [stop control (initial value)] unless otherwise required.

Setting procedure of burnout control selection

The following steps explain how to set the burnout control selection to “on (maintain control)” as an example.



- 1 Press and hold the  key to display the setup mode channel menu (“oPE [h 1]”), then use the   keys to display CFG (“CFG [h 3]”).



 Refer to page 143 of this chapter for how to display the channel menu.

- 2 Press and hold the  key and use the   keys to display to bCon (“bCon”).



- 3 Press the  key, then use the   keys to set “on” when the bottom part of the display begins to blink.

This example selected “maintain control” when burnout is detected.

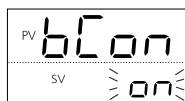

- 4 Press the  key to confirm the setting.

- 5 Press the  key to return to the operation mode PV/SV display.

Ramp soak pattern order



You can change the ramp soak pattern order.
The setting items of the ramp soak pattern order are as follows:

5 Press the  key to return to the operation mode PV/SV display.

Display	Meaning	Pattern No. (PTn)	Run step
0:	Normal order	0	Step 1 to step 4
		1	Step 5 to step 8
		2	Step 1 to step 8
		3	Step 9 to step 12
		4	Step 13 to step 16
		5	Step 9 to step 16
		6	Step 1 to step 16
1	Special order	0	Step 1 to step 4
		1	Step 5 to step 8
		2	Step 9 to step 12
		3	Step 13 to step 16
		4	Step 1 to step 8
		5	Step 9 to step 16
		6	Step 1 to step 16



Changing the Ramp Soak Pattern Order

This section explains how to change the ramp soak pattern to the customized order.



- 1** Press and hold the  key to display the setup mode channel menu ("oPE [h 1]"), then use the   keys to display CFG ("CFG [h 3]").



Refer to  Refer to page 143 of this chapter for how to display the channel menu.

- 2** Press and hold the  key, then use the   keys to display PTnT ("PfnT").



- 3** Press the  key, then use the   keys to set the ramp soak pattern to "1" when the bottom part of the display begins to blink.

The ramp soak pattern is set to the special order.



- 4** Press the  key to confirm the setting.



L-C2 C2 Lamp Allocation

The C2 lamp output can be allocated to display the following information.

Setting	Conditions where C2 Lamp Blinks
0:	MV2 output/CLOSE output (lights/blinks, but the AO output does not function.)
1:	during manual mode
2:	during standby
3:	during remote SV mode
4:	no function (do not set)
5:	during soft start
6:	during ramp SV
7:	during ramp/soak
8:	during SV selection (when other than front SV is selected)
9:	during PID selection (when PID other than Pid channel is selected)
10:	during auto-tuning



Setting the C2 Lamp Allocation

This section explains how to allocate the lamp by using C2 = Auto Tuning as an example.

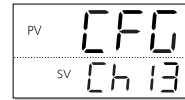

- 1 Press and hold the  key to display the setup mode channel menu ("oPE Ch 1"), then use the   keys to display CFG ("CFG Ch 13").

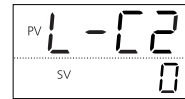

Refer to  See p. 143 in this chapter for information on how to display the channel menu.

- 2 Press and hold the  key, then use the   keys to select LC-2 ("LC-2").



- 3 Press the  key, then use the   keys to select "10" when the bottom part of the display begins to blink.

LED C2 is allocated to Auto Tuning.

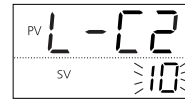

- 4 Press the  key to confirm the setting.

- 5 Press the  key to return to the operation mode PV/SV display.



Controller Reset

This section explains how to specify whether or not the main unit is reset.

- Range oFF : Do nothing
rST : Reset Main Unit



The main unit reset function is equivalent to turning the power on and off.

Resetting the Main Unit



- 1 Press and hold the  key to display the setup mode channel menu ("oPE [h 1]"), then use the   keys to display CFG ("CFG [h 13]").

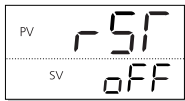

Refer to  See p. 143 in this chapter for information on how to display the channel menu.

- 2 Press and hold the  key, then use the   keys to display rST ("rSt").



- 3 Press the  key, then use the   keys to select "on" when the bottom part of the display begins to blink.

This sets "resets the main unit".

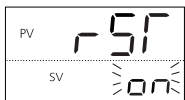

- 4 Press the  key to reset the main unit. When the main unit resets, the following display will appear and the unit will start up in operation mode.

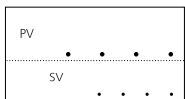

MEMO

Chapter 16

Troubleshooting

Troubleshooting – 152

Troubleshooting

When symptoms thought to be damage occur, first check that there are no problems with the model purchased, wiring, or parameter settings. The following lists examples of frequent problems and their solutions.

Trouble	Cause	Solution	Reference Ch
Cannot communicate with the host	Parity does not agree.	Make the parity on the host and the unit the same.	Ch9
	Communication speed does not agree.	Make the communication speed on the host and the unit the same.	
Parameters you want to view do not appear	Display mask is set.	Check the DSP settings.	Ch12
	A password is set.	Release the password with Super PASS.	Ch11
Control output is not output even with the power turned on	Soft start is set.	Check the soft start settings.	Ch6
	The ramp/soak settings have the output turned OFF.	Check the ramp/soak settings.	Ch4
	Standby mode is on.	Check the output settings during standby mode.	Ch6
Manual mode cannot be changed	Manual mode is not assigned to the USER key.	Check the USER key assignments.	Ch7
	The DI function is not set to manual mode.	Check the DI function settings.	
Keys do not work	Key lock is set to ON.	Check the key lock settings.	Ch1
	SV limit value is set.	Check the SV limit value settings.	Ch2
	The USER key settings have changed.	Check the USER key settings.	Ch7
Channel parameters cannot be displayed	Password is incorrect.	Release the password with Super PASS.	Ch11
	Forgot the password.		
Power will not turn on	Equipment with 24V specification was connected to AC 100V or more.	Please request repair.	—
SV blinks when power is turned on	Standby is turned ON.	Release standby.	Ch1
	Ramp/soak status is "END".	Change the ramp/soak settings.	Ch1
	ALMF is set.	Check the ALMF settings.	Ch13
Control does not start even if power is turned on	STMD mode is set to manual output.	Check the STMD settings.	Ch7
Cannot perform valve control correctly	The valve is not correctly connected.	Check the valve connections.	Ch10

Chapter 17

Appendix

Delay Start Function – 154



Return to Factory Default Setting Function – 155

Delay Start Function

Ramp soak can be automatically started (RUN) after a certain period of time has elapsed since the power of the controller is turned on.

This function is enabled by setting the digital input function (DI n) and the digital output function (DoT), and the delay time can be set with dLYn.

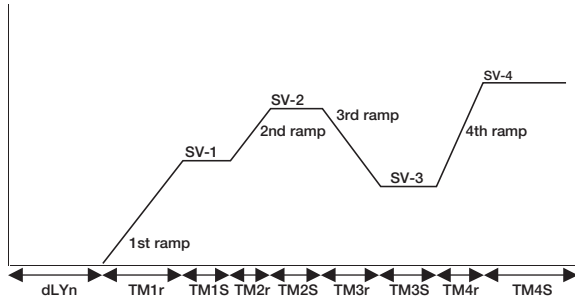

The delay start function is enabled by setting di1-5, do1T-do5T (SYS Ch7), dLY1-5, and dL1U-dL5U (ALM Ch8).

Setting range of each parameter when enabling delay start:

di1 to di5	: 44 to 48
do1T to do5T	: 35
dLY1 to dLY5	: 0 to 9999
dL1U to dL5U	: Min/Sec

Setting MOD (PrG Ch4) or SbMd (SET Ch 6) can realize the following operation.

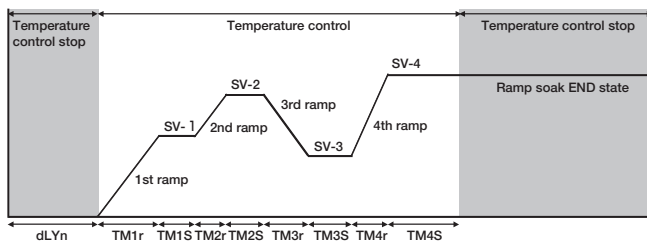

To have the unit operate as in the figure above, configure the settings as follows:

Mod	: 6
StMd	: 1

This figure sets the PTn (PrG Ch4) to 0, but any value can be set for the PTn to realize the similar operation.

Setting the Delay Start Function

The following steps will explain how to assign the delay start to DI 2, Do2 and to set the delay time to 15 minutes.

* For the detailed setting for each parameter, see the setting procedure for each parameter.



- 1 Display the system menu (SYS Ch7).
- 2 Display the Di2 function selection ("dL2"), and set 45 ("45").
- 3 Display the DO2 output event type setting ("do2f"), and set 35 ("35").
- 4 Display the Alarm (ALM Ch8).
- 5 Display the ALM2 delay time ("dLY2"), and set 15 ("15").
- 6 Display the ALM2 delay time unit ("dL2U"), and set the minute ("min").
- 7 Press the  key to return to the operation mode PV/SV display.

Return to Factory Default Setting Function

The set values for all of the parameters can be returned to the factory default setting. This function is useful in various situations, such as when you want to redo the settings.

Setting the Return to Factory Default Setting Function

Follow the steps below to return all values to the factory default setting.

- 1** Display the password setup PAS Ch11 ("PAS Ch 11").
- 2** Display "PAS 1" and set FE01 ("FEO1").
- 3** Display "PAS2" and set FE02 ("FEO2").
- 4** Display "PAS3" and set FE03 ("FEO3").
- 5** Press the  key to return to the PV display.
- 6** Press and hold the  key to display "P01".
- 7** Press the  key to display "PASS" and set FE00 ("FEO0").
- 8** When the "PASS" setting returns to 0000 ("0000"), the values have finished returning to their factory default settings.

MEMO

Fuji Electric Co., Ltd.

International Sales Div
Sales Group

Gate City Ohsaki, East Tower 11-2, Osaki 1-chome,
Shinagawa-ku, Tokyo 141-0032, Japan

<http://www.fujielectric.com>

Phone: 81-3-5435-7280, 7281 Fax: 81-3-5435-7425

<http://www.fujielectric.com/products/instruments/>
