

Instruction Manual



Micro Controller X Model: PXG4

Fuji Electric Co., Ltd.

INP-TN1PXG4e-E

International Sales Div

Sales Group

Gate City Ohsaki, East Tower 11-2, Osaki 1-chome,

Shinagawa-ku, Tokyo 141-0032, Japan

http://www.fujielectric.com

Phone: 81-3-5435-7280, 7281 Fax: 81-3-5435-7425

http://www.fujielectric.com/products/instruments/

Thank you for purchasing the Fuji Digital temperature Controller.

Once you have confirmed that this is the product you ordered, please use it in accordance with the following instructions.

For detailed information on operating this equipment, please refer to the separate operations manual.

In addition, please keep this instruction manual within easy reach of the actual person using this equipment.

CAUTION

The contents of this manual are subject to change without notice.

This manual is compiled with possible care for the purpose of accuracy, however, Fuji Electric

Systems shall not be held liable for any damages, including indirect damage, caused by typographical errors, absence of information or use of information in this manual.

Confirming Specifications and Accessories

Before using the product, confirm that it matches the type ordered.

(For model code, please refer to page 19.)

Confirm that all of the following accessories are included.

Temperature Controller	1 unit
Instruction Manual	1 copy
Mounting bracket	1 pc
I/V Unit (250W Resistor)	1 pc
Waterproof packing	1 pc
Unit nameplate	1 pc

Option

Name	Order No.
Terminal cover	ZZPPXR1-A230
PC loader communication cable	ZZPPXH1*TK4H4563

Related Information

Refer to the following reference materials for details about the items described in this manual.

Document	Reference No.
Catalog	ECNO:1125
Micro Controller (Model: PXG) Operation Manual	ECNO:1411
Micro Controller (Model: PXG) Communication Functions Manual (MODBUS)	INP-TN514450-E

The latest materials can also be downloaded at the following URL: <http://www.fic-net.jp/eng>

1-2 / Installation and Wiring

● This equipment is intended to be used under the following conditions.

Ambient temperature	-10 °C to 50 °C
Ambient humidity	90% RH or below (with no condensation)
Installation category	II by IEC 1010-1
Pollution level	2

● Between the temperature sensor and the location where the voltage reaches or generates the values described below, secure clearance space and creepage distance as shown in the table below.

If such space cannot be secured, the EN61010 safety compliance may become invalid.

Voltage used or generated by any assemblies	Clearance Space (mm)	Creepage Space (mm)
Up to 50 Vrms or Vdc	0.2	1.2
Up to 100 Vrms or Vdc	0.2	1.4
Up to 150 Vrms or Vdc	0.5	1.6
Up to 300 Vrms or Vdc	1.5	3.0
Above 300 Vrms or Vdc	Please consult our distributor	

hazardous voltage

● For the above, if voltage exceeds 50Vdc (called danger voltage), grounding and basic insulation for all terminals of the equipment, and auxiliary insulation for digital outputs 1 to 3 is required. Note that the insulation class for this equipment is as follows. Before installing, Please confirm that the insulation class for equipment meets usage requirements.

- Basic insulation (1500VAC)
- Functional insulation (500VAC)
- - - No insulation

Power		Internal circuit	
Control output 1 (Relay contact) or Motorized valve OPEN output		Measurement input	
		Auxiliary analog input (remote SV)	
Control output 2 (Relay contact) or Motorized valve CLOSE output		Heater current detector input	
		Control output 1 (SSR drive, current, voltage)	
Digital output 1 (Relay contact)	Digital output 1 to 3 (Relay contact)	Control output 2 (SSR drive, current, voltage)	
Digital output 2 (Relay contact)		or Auxiliary analog output (Re-transmission output)	
		Digital input 1 to 3	
		Communication (RS-485)	

When the ninth digit in the model code is J (Do1,2 are independent common) When the ninth digit in the model code is not J (Do1 to 3 shared common)

- In cases where damage or problems with this equipment may lead to serious accidents, install appropriate external protective circuits.
- As this equipment does not have a power switch or fuses, install them separately as necessary. Fuse should be wired between main power switch and this equipment. (Main power switch: Bipolar breaker, fuse rating: 250V 1A)
- For power supply wiring, use wire equal to 600V vinyl insulated wire or above.
- To prevent damage and failure of the equipment, provide the rated power voltage.
- To prevent shock and equipment failure, do not turn the power ON until all wiring is complete.
- Before turning on power, confirm that clearance space has been secured to prevent shock or fire.
- Do not touch the terminal while the machine is on. Doing so risks shock or equipment errors.
- Never disassemble, convert, modify or repair this equipment. Doing so risks abnormal operation, shock or fire.
- Output relay is the part has a limited life. When output relay contact comes to the end of its life, it might remain on-state, or off-state. For safety, use a protective circuit outside.

1-3 / Maintenance

- When installing or removing the equipment, turn the power OFF. Otherwise, shock, operational errors or failures may be caused.
- Periodic maintenance is recommended for continuous and safe use of this equipment.
- Some parts installed on this equipment have a limited life and/or may deteriorate with age.
- The warranty period for this unit (including accessories) is one year, if the product is used properly.

2 ⚠ Caution

2-1 / Cautions when Installing

Please avoid installing in the following locations.

- Locations in which the ambient temperature falls outside the range of -10 to 50°C when equipment is in use. (If the power supply is 200V AC, the recommended maximum ambient temperature is 45°C.)
- Locations in which the ambient humidity falls outside the range of 45 to 90% RH when equipment is in use.
- Locations with rapid temperature changes, leading to dew condensation
- Locations with corrosive gases (especially sulfide gas, ammonia, etc.) or flammable gases.
- Locations with vibration or shock directly.
- Locations in contact with water, oil, chemicals, steam or hot water. (If the equipment gets wet, there is a risk of electric shock or fire, so have it inspected by Fuji distributor.)
- Locations with high concentrations of atmospheric dust, salt or iron particles.
- Locations with large inductive interference, resulting in static electricity, magnetic fields or noise
- Locations in direct sunlight.
- Locations that build up heat from radiant heat sources, etc.

Please Read First (Safety Warnings)

Please read this section thoroughly before using and observe the mentioned safety warnings fully. Safety warnings are categorized as "Warning" or "Caution".

⚠ Warning	Mishandling may lead to death or serious injury.
⚠ Caution	Mishandling may cause injury to the user or property damage.

1 ⚠ Warning

1-1 / Limitations in Use

This product was developed, designed and manufactured on the premise that it would be used for general machinery.

In particular, if this product is to be used for applications that require the utmost safety as described below, please take into consideration of the safety of the entire system and the machine by adopting such means as a fail-safe design, a redundancy design as well as the conducting of periodical inspections.

- Safety devices for the purpose of protecting the human body
- Direct control of transportation equipment
- Airplanes
- Space equipment
- Atomic equipment, etc

Please do not use this product for applications which directly involve human lives.

2-2 / Cautions when Attaching to the Panels

- Insert the controller unit into the panel cutout from the front, and then put the mounting bracket from the rear. The mounting bracket should be pushed in until the controller is securely fixed to the panel. If there is a slight gap remaining, gently tighten the two screws until the gap disappears. (Make sure not to over tighten the screws, as doing so may result in the mounting bracket separating from the stopper.)
- The front of this equipment is waterproof in compliance with NEMA-4X standards (IP66-equivalent). To effect waterproof, the included packing is shall be attached between the controller and the panel according to the guidelines below. (Incorrect attachment may cause the equipment to lose its waterproof capabilities.)
 - As shown in Fig. 1, insert to the panel after attaching the packing to the equipment case.
 - As shown in Fig. 2, tighten the fixture screws so that no gaps remain between the equipment face, the packing and the panels. Once finished, confirm that there are no changes in shape such as displaced or improperly-fitted packing, etc. as shown in Fig. 3.
- If the panel does not have enough strength, gaps may develop between the packing and the panel to lose waterproofing capabilities.

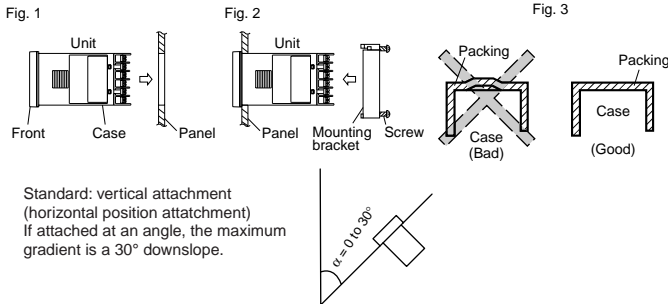

- Caution**
- In order to aid heat dissipation, do not block the sides of the equipment.
 - Do not block the air vents on the upper part of the terminal.

2-3 / Cautions for Wiring

- For thermocouple input, use the designated compensation lead; for resistance bulb input, use wires with small lead wire resistance and without any resistance difference among the three wires.
- To avoid noise conductor effects, input signal wires should be separated from electric power lines or load lines.
- Input signal wire and output signal wire should be separated each other. And both should be shield wire.
- If there is a lot of noise from the power source, adding an insulation transducer and using a noise filter is recommended. (Example: ZMB22R5-11, noise filter Maker: TDK)
Always attach a noise filter to a panel that is grounded securely, and keep the wiring between the noise filter output side and the measuring equipment power terminal wiring to a minimum length.
Please do not attach fuses and switches, etc. to the noise filter output wiring, otherwise the filter's effectiveness will be decreased.
- Twisting the power wires is effective when connecting the wires. (The shorter the pitch of the twist, the more effective the connection is against noise.)
- If there is a function of heater current detection, heater wires and power wires should be connected with same power line.
- Operation preparation time is required for the contact output when power is turned on. If using it as a signal to an external interlock circuit, please couple it with a delayed relay.
- Concerning the output relay, connecting the maximum rated load will shorten the product's life; so please attach an auxiliary relay. If the output operation frequency is high, selecting a SSR/SSC drive output type is recommended.
[Proportionate cycles] Relay output: 30 seconds or more, SSR/SSC drive output: 1 second or more
- When inductive loads such as magnetic opening/closing equipment, etc. as relay output equipment are connected, use of "Z-trap," manufactured by Fuji Electric Device Technology Co., Ltd., is recommended in order to protect the contacts against opening/closing surges and to ensure long-term use.
Model names : ENC241D-07A (For 100V power voltage)
ENC471D-07A (For 200V power voltage)
Attachment position : Please connect between the relay control output contacts. (Refer to Fig. 4.)

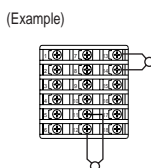

Fig.4 Attachment position of Z-Trap

2-4 / Key Operation Cautions/Error Operations

- The alarm function does not work properly when an error takes place unless the settings are made correctly. Always verify its setting before operation.
- If the input wiring breaks, the display will read "UUUUU". When replacing the sensor, always turn the power OFF.

2-5 / Others

- Please do not wipe the equipment with organic solvents such as alcohol or benzene, etc. If wiping is necessary, use a neutral cleaning agent.
- Do not use mobile phones near this equipment (within 50 cm). Otherwise a malfunction may result.
- Trouble may occur if the equipment is used near a radio, TV, or wireless device.

For Proper Usage

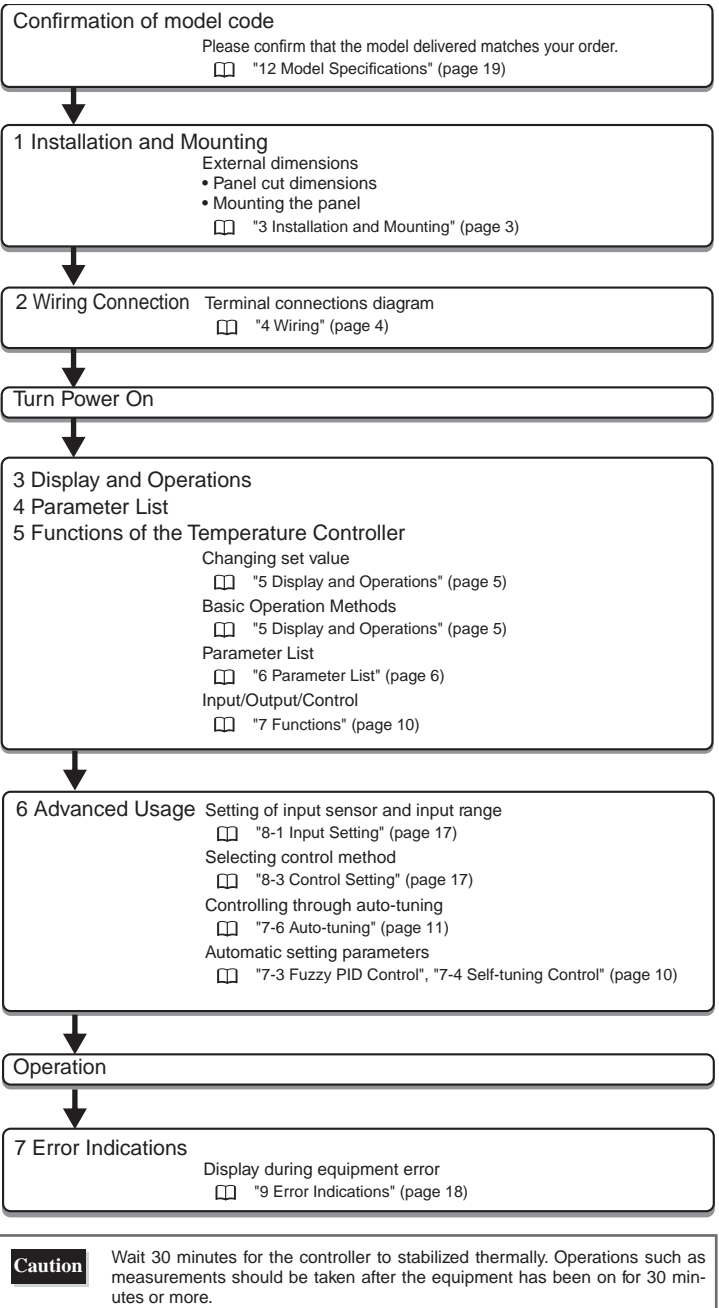

3 Installation and Mounting

3-1 External/Panel Cut Dimensions

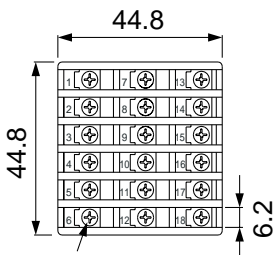
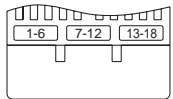
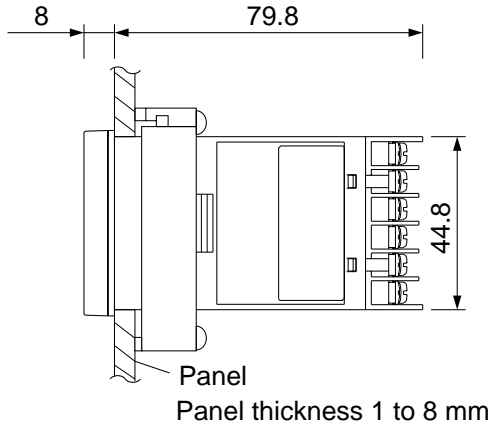
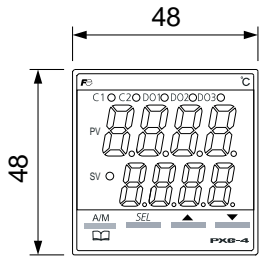

Terminal screw M3

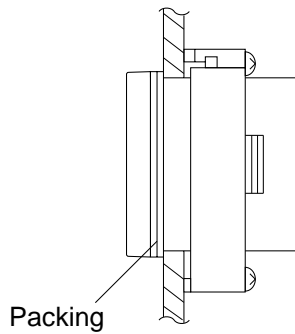

PC loader interface

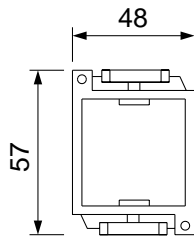
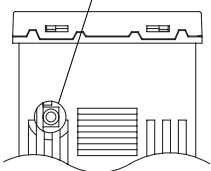

Mounting bracket

installing multiple controllers

Installing multiple controllers horizontally
(In this installing, the waterproof of PXG is lost.)

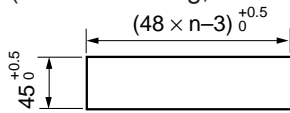
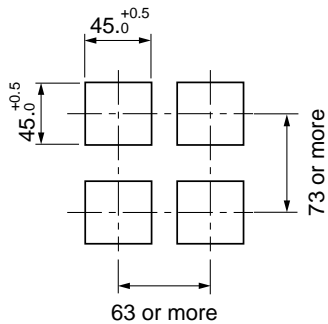

Caution Panel cut dimensions should also meet the above dimensions after the panel is coated.

Cautions when Close Fit Mounting:

- When the power supply is AC 200V, keep the maximum ambient temperature at 45°C. For vertical close-fit mounting, use a power source of 100V AC. (In both cases, a fan is recommended as a measure against radiation.)
- When there is an instrument larger than 70 mm or a wall to the right of the controller, move it as least 30 mm away.

Cautions when wiring:

- Start by wiring from the left-hand terminals (terminals 1 to 6).
- Use a screw that is the right size on terminals and tighten them with a torque of about 0.8 N/m.
- Do not attach anything to unused terminals. (Do not use relay terminals.)

4 Wiring

4-1 Terminal Connection Diagram (100 to 240V AC, 24V AC/DC)

● Standard Type

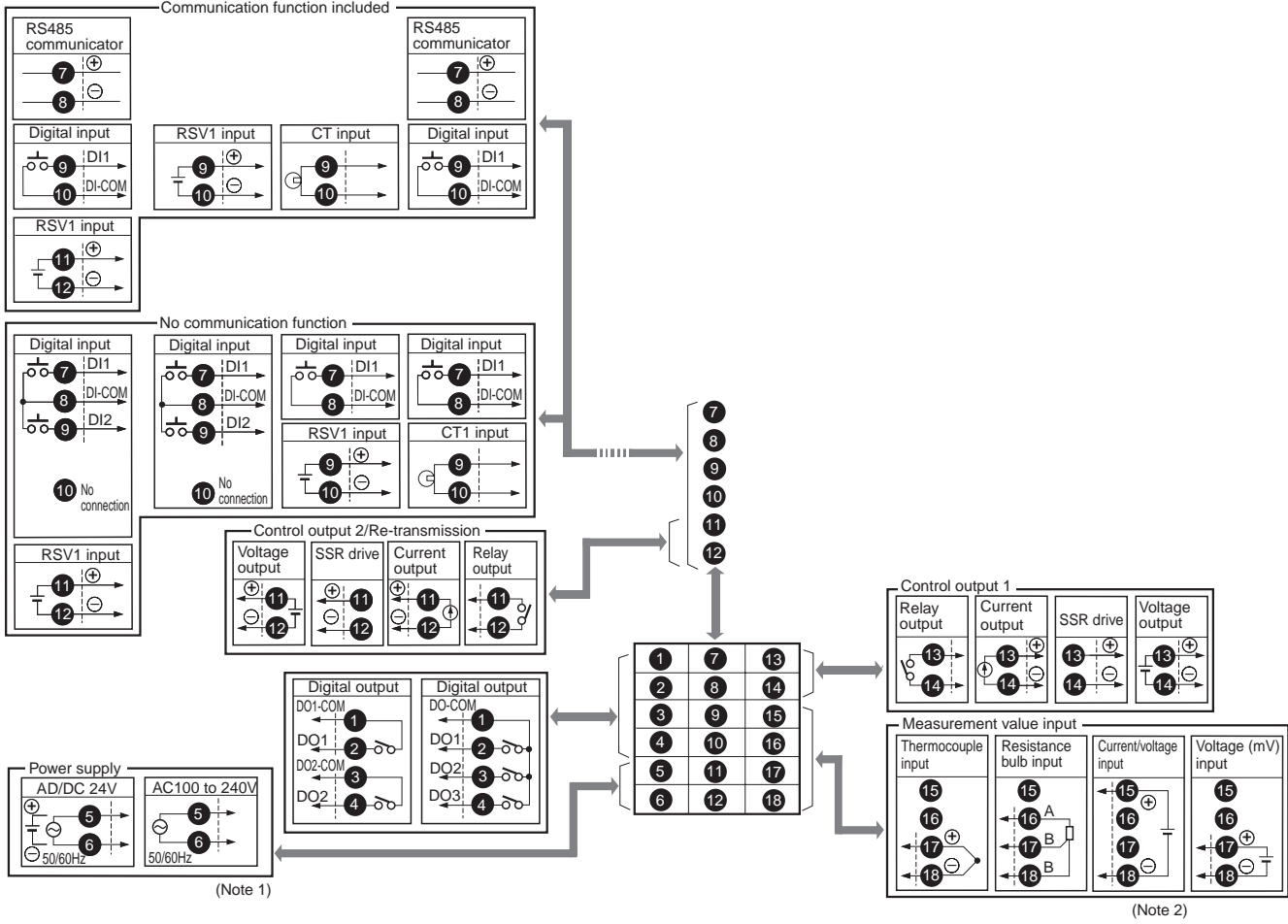

● Motorized Valve Type

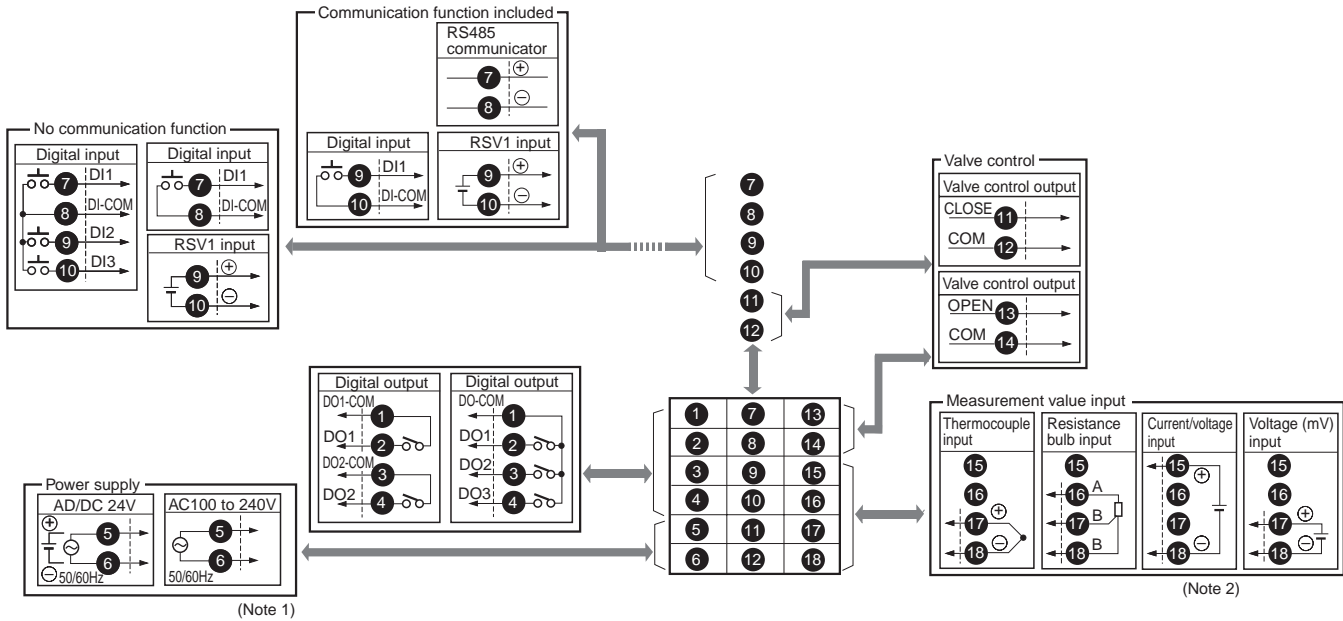

Note 1: Check the power supply voltage before making the connections.

Note 2: When inputting current, connect the additional I/V unit (250Ω resistor) between the terminals number 15 and 18.

5 Display and Operations

5-1 Part names and functions

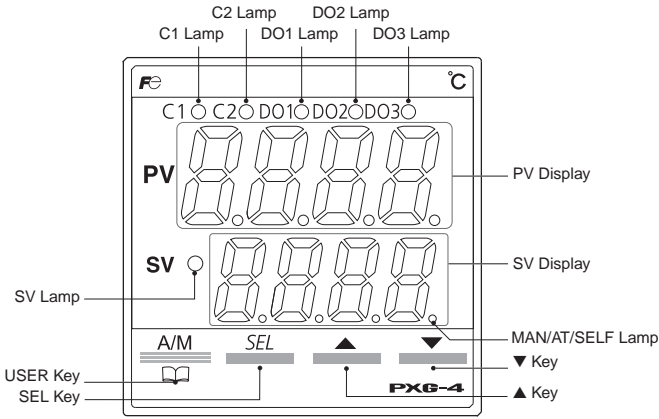

Operation Parts

USER Key
Switches this key in monitoring mode display or setup mode display returns you to the PV/SV display. Pressing this key on the PV/SV display allows you to set the function for "UEE" under the system menu ("55 Ch T"). (The factory set function for this key is switching between auto and manual.)

SEL Key
Switches the PV/SV display to the monitoring mode display or setup mode display. Switches to setup mode when parameter display, and this key functions as the select key when changing parameters. Holding this key down in channel display or parameter display returns you to the PV/SV display. Pressing this key at PV/SV display in manual mode, manual output value is shown in the lower display.

▲ Key
Pressing once will increase the setting value by one. Holding down the button will continue to increase the value. It changes SV on the PV/SV display. It is also used to move between items in channel screen display and parameter screen display.

▼ Key
Pressing once will decrease the setting value by one. Holding down the button will continue to decrease the value. It changes SV on the PV/SV display. It is also used to move between items in channel screen display and parameter screen display.

Display

C1/C2 Lamp
Displays the condition of the control output. Lights ON at 100% output and goes out at 0% output. For values between 0% and 100%, the output is indicated by the length of time the lamp flickers. When acting as a valve control, the C1 lamp will light with OPEN output, and the C2 lamp will flicker with CLOSE output.

DO1/2/3 Lamp
Lights ON when there is digital output is on state (DO1, DO2, DO3). The lamp flickers when delay behavior is on.

PV Display
Displays the measurement value (PV). Displays the name of the parameter when setting parameters.

SV Display
Displays the setting value (SV). Also can display the output value during manual mode. Displays the parameter setting value when setting parameters. Displays "rE" during remote SV operation, and "5oF" and set value alternately during soft start.

SV Lamp
Lights when displaying the setting value (SV). Goes out when displaying the manual output value. The lamp flickers while performing ramp soak or lamp SV operations.

MAN/AT/SELF Lamp
Normally lights up during manual mode and blinks during auto-tuning or self-tuning.

5-2 Monitor Display and Status Display

In monitor mode, the PV display shows item names, while the SV display shows the input/output values.

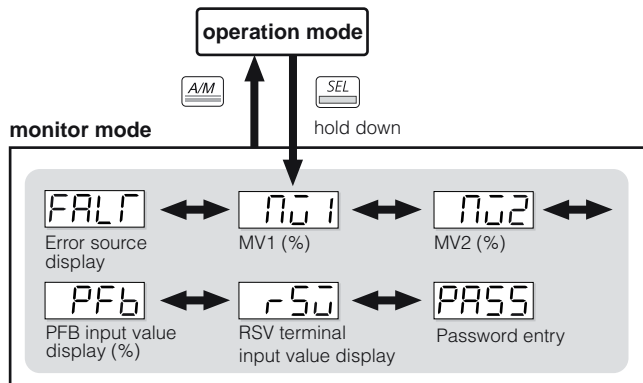

For more details on "PR55" (PASS), see "5-6 Key Lock and Password" (page 6).

Parameter display symbol	Parameter name	Function	Setting range	Remarks
"FALF" (FALT)	Error source display	Displays the source of an error	FALT = <input type="checkbox"/> 00 [fixed at 0 8bit : PV input underflow 9bit : PV input overflow 10bit: underrange 11bit: overrange 12bit: RSV underrange 13bit: RSV overrange 14bit: range setting error 15bit: EEPROM error]	
"rE" (Mv1)	MV1	Displays the output value of the control output (OUT1)	-3.0 to 103.0%	
"rE2" (Mv2)	MV2	Displays the output value of the control output (OUT2) (during dual control)	-3.0 to 103.0%	(Note4)
"r50" (rSV)	RSV input value display	Displays the input value of the RSV	-5 to 105% FS	(Note1)

For more details on (Note) in the Remarks column, see "6 Parameter List" (page 6).

5-3 Basic Operations

Pressing the A/M key or the SEL key switches between modes. Pressing ▲ ▼ in monitor mode or setup mode allows you to choose menu items.

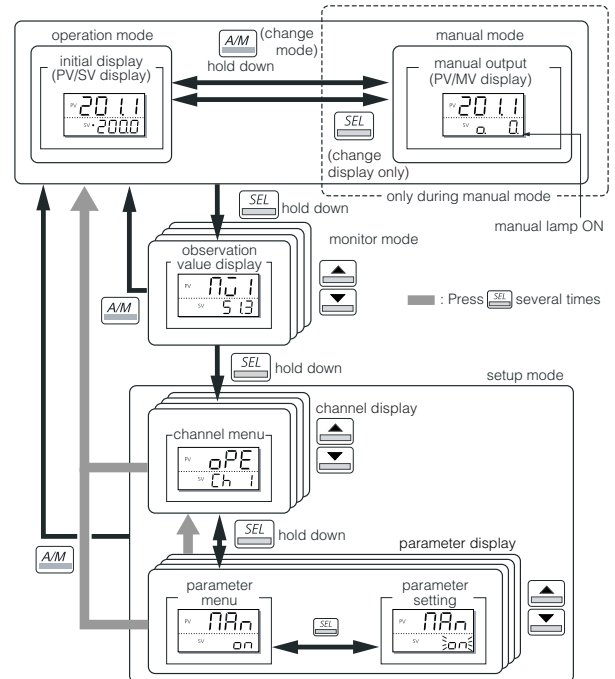

- Changing SV (set values)
 - 1 Change the display to PV/SV display (shown when you turn on the power and the SV lamp is lit).
 - 2 Change the SV with the ▲ ▼ keys.
 - 3 Press the SEL key to save the values. (The value will be automatically saved after 3 seconds even if a key is not pressed.)
- Changing MV (control output values)
 - 1 Switch to manual mode.
 - 2 Change the display to PV/MV display (MAN/AT/SELF lamp is lit). (Pressing the SEL key in manual mode toggles between PV/SV display and PV/MV display.)
 - 3 Change the MV with the ▲ ▼ keys. (Changes are reflected to the MV as it is changed.)

Refer to See "7-8 Manual Output" (page 12) for more about changing to manual mode.













5-4 Operations

For the following modes, the PV display will show the PV input value.

- Operation Mode
SV display shows the SV setting value.
- Manual Mode
An LED light decimal point lights ON in the lowest digit place in the SV display. An "o" appears in the highest decimal place when values are being set. Pressing the ▲ ▼ keys sets the MV (%).

5-5 / Setting Parameters



The following explains how to set the parameters.

- 1 **Press and hold the  key in operation mode, or manual mode.**
This switches you to the monitor mode MV1.
 - 2 **Press and hold the  key in monitor mode**
This switches you to the channel menu of setup mode.
 - 3 **Choose the channel with the   keys, then press and hold the  key.**
This switches you to the parameter menu.
 - 4 **Choose the parameter with the   keys, then press the  key.**
The set value flickers.
 - 5 **Choose the parameter with the   keys, then press the  key.**
The set value is fixed.
- No matter where you are in monitor or setup mode, pressing the  key returns you to operation mode. When setting the parameters in manual mode, pressing the key holds manual mode and returns you to operation mode.

5-6 / Key Lock and Password



Setting Key Lock

When key lock is activated, parameters cannot be changed but can be displayed. Use the following steps to set key lock.



- 1 **Display the operation menu ("oPE Ch 1").**
- 2 **Display key lock ("LoC") and press the  key.**
- 3 **Set the value.**
0 : No lock (all parameters can be changed. Initial value.)
1 : All lock (no parameters can be changed.)
2 : All lock without SV (only the SV can be changed.)
- 4 **Press the  key to set the value.**

Saving and entering a password

Use the following steps to save a password.

- 1 **Display the password menu ("PAS Ch 1").**
 - 2 **Display password 1 ("PAS 1") and press the  key.**
 - 3 **Set the password.**
You can enter the hexadecimal value 0000 through FFFF.
 - 4 **Press the  key to set the value.**
"PAS2" and "PAS3" can be saved in the same way.
- The authority of the passwords grows from "PAS 1" to "PAS2" to "PAS3". The higher the authority, the greater number of channels for display and settings.

Use the following steps to enter a password.

- 1 **In monitoring mode, display ("PASS") and press the  key.**
- 2 **Enter a saved password and press the  key.**
You will be able to operate the equipment depending on the authority of your password.

Point Each parameter channel and the authority of passwords 1 to 3

oPE ch	Pid ch	PLT ch	PrG ch	Mon ch	SET ch	SyS ch	ALM ch	CoM ch	PFb ch	PAS ch	dSP ch
--------	--------	--------	--------	--------	--------	--------	--------	--------	--------	--------	--------

Password level

PAS1 permissions	<"PASS" = "PAS 1">
PAS2 permissions	<"PASS" = "PAS 2">
PAS3 permissions	<"PASS" = "PAS 3">

Note: When "FEFE" (FEFE) is entered as "PASS" (PASS), all of the channels "OPE ch" to "DSP ch" can be displayed and set. This "super password" function is useful when you forget the set passwords.

6 Parameter List

The following explains each channel parameter.

The list also shows the operational range of set values for parameters that are limited.

- When the PV input lower limit (Pvb), PV input upper limit (PvF), or decimal place position (Pvd) is changed, reconfigure all the initial parameter setting values.
- When the parameter that has  on its Remarks column is changed, turn off the power once, and then re-start the controller.

6-1 / Operation (Ch1)

The following is a menu to operate the controller. Switchover between auto and manual control output, switchover between RUN and standby, and other such functions.

Parameter display symbol	Parameter name	Function	Setting range	Initial value	Remarks
"rRn" (MAN)	Switchover between auto and manual mode	Switchover between auto and manual modes	oFF (auto) / on (manual)	oFF	
"Stby" (STby)	Switchover between RUN and standby	Switchover the operation mode between RUN and standby	oFF (RUN) / on (standby)	oFF	
"rEM" (rEM)	Switchover between local and remote SV operation	Switchover between local and remote SV operation	LoCL (local) / rEM (remote)	LoCL	(Note1)
"PrG" (PrG)	Ramp soak control command	Changes ramp soak run states	oFF (stop) rUn (run) hLd (hold)	oFF	Displays End (when ending) or GS (during guaranty soak).
"AT" (AT)	Auto-tuning run command	Runs auto-tuning.	oFF (stop/finish) on (normal type) Lo (low PV type)	oFF	
"LrCh" (LrCh)	DO output latch release command	Cancels the DO latch state	oFF / rST (latch resets)	oFF	(Note2)
"Svn" (Svn)	Currently selected SV No.	Choose the SV No. used for control	Sv0 Sv1 Sv2 Sv3 Sv4 Sv5 Sv6 Sv7 di (chooses SV according to di)	Sv0	(Note19)
"PLn" (PLn1)	Currently selected PID No.	Choose the Pid group No. used for control	Pid 0 (PID ch) Pid 1 (PID group No. 1) Pid 2 (PID group No. 2) Pid 3 (PID group No. 3) Pid 4 (PID group No. 4) Pid 5 (PID group No. 5) Pid 6 (PID group No. 6) Pid 7 (PID group No. 7) di (chooses PID group according to di)	Pid0	
"AL" (AL1) "AL" (AL1L) "AL" (AL1h) : "AL" (AL3) "AL" (AL3L) "AL" (AL3h)	AL1 set value AL1L set value AL1h set value : AL3 set value AL3L set value AL3h set value	Set the alarm value.	0 to 100% FS (absolute value alarm) -100 to 100% FS (deviation alarm)	10°C	(Note3)
"LoC" (LoC)	Key lock	Sets the key lock to prevent wrong operation	0 (no lock) 1 (all lock) 2 (All but SV locked)	0	

6-2 / PID (Ch2)

Sets parameters for controls such as PID.

Parameter display symbol	Parameter name	Function	Setting range	Initial value	Remarks
"P" (P)	Proportional band	Sets the proportional band of the PID parameter. Setting "0.0" will turn it to an ON/OFF control.	0.0 to 999.9%	5.0%	
"i" (i)	Integration time	Sets the integration time of the PID parameter. Setting "0" will turn off integration.	0 to 3200 sec	240 sec	
"d" (d)	Differential time	Sets the differential time of the PID parameter. Setting "0.0" will turn off derivation.	0.0 to 999.9 sec	60.0 sec	
"hyS" (hyS)	ON/OFF control hysteresis	Sets the hysteresis width for the ON/OFF control.	0 to 50% FS	1°C	
"CoL" (CoL)	Cooling proportional band coefficient	Sets the cooling proportional band coefficient. Setting "0.0" will turn the cooling into an ON/OFF control.	0.0 to 100.0	1.0	(Note4)

Parameter display symbol	Parameter name	Function	Setting range	Initial value	Remarks
"db" (db)	Dead band	Shifts the cooling proportional band from the set value	-50 to 50%	0%	(Note4)
"bAL" (bAL)	Output convergence value	Offset value which is added to the MV output value	-100 to 100%	0/50 (single/dual)	
"Ar" (Ar)	Anti-reset windup	Sets the range of integration control	0 to 100% FS	100% FS	
"rEv" (rEv)	Sets normal/reverse operations	Sets the control action	rv-- (heat (reverse) /cool (none)) no-- (heat (normal) /cool (none)) rvno (heat (reverse) /cool (normal)) norv (heat (normal) /cool (reverse)) rvrv (heat (reverse) /cool (reverse)) nono (heat (normal) /cool (normal))	rv--/rvno (single/dual)	RST
"SVL" (SVL)	SV limit (lower limit)	Sets the lower limit of SV	0 to 100% FS	0% FS	(Note5)
"SVH" (SVh)	SV limit (upper limit)	Sets the upper limit of SV	0 to 100% FS	100% FS	(Note5)
"TC1" (TC1)	OUT1 proportion cycle	Sets the proportion cycle of the control output (OUT1) (contacts, SSR drive)	1 to 150 sec	30: Contact 2: SSR drive	(Note7)
"TC2" (TC2)	OUT2 proportion cycle	Sets the proportion cycle of the control output (OUT2) (contacts, SSR drive)	1 to 150 sec	30: Contact 2: SSR drive	(Note4) (Note16)
"PLC1" (PLC1)	OUT1 lower limit	Sets the lower limit of the control output (OUT1)	-3.0 to 103.0%	-3.0%	
"PhC1" (PhC1)	OUT1 upper limit	Sets the upper limit of the control output (OUT1)	-3.0 to 103.0%	103.0%	
"PLC2" (PLC2)	OUT2 lower limit	Sets the lower limit of the control output (OUT2)	-3.0 to 103.0%	-3.0%	(Note4)
"PhC2" (PhC2)	OUT2 upper limit	Sets the upper limit of the control output (OUT2)	-3.0 to 103.0%	103.0%	(Note4)
"PCUT" (PCUT)	Selects the type of output limiter	Sets the type of output limiter	0 to 15	0	

6-3 / PID Palette (Ch3)

Saves the palette values of PV and PID. Up to seven sets can be saved.

Parameter display symbol	Parameter name	Function	Setting range	Initial value	Remarks
"SV1" (SV1)	SV 1	Sets the SV set value	SV limit (lower) (SVL) to SV limit (upper) (SVH) %FS	0%FS	(Note5)
"P1" (P1)	Proportional band 1	Sets the proportional band	0.0 to 999.9%	5.0%	
"i1" (i1)	Integration time 1	Sets the integration time	0 to 3200 sec	240 sec	
"d1" (d1)	Differential time 1	Sets the differential time.	0.0 to 999.9 sec	60.0 sec	
"hyS1" (hyS1)	ON/OFF control hysteresis 1	Sets the hysteresis when using the ON/OFF control.	0 to 50% FS	1 °C	
"CoL1" (CoL1)	Cooling proportional band 1	Sets the cooling proportional band	0.0 to 100.0	1.0	(Note4)
"db1" (db1)	Dead band 1	Sets the dead band	-50.0 to 50.0%	0%	(Note4)
"bAL1" (bAL1)	Output convergence value 1	Offset value which is added to the control output	-100.0 to 100.0%	0/50 (single/dual)	
"Ar1" (Ar1)	Anti-reset windup 1	Sets the anti-reset windup	0 to 100% FS	100% FS	
"rEv1" (rEv1)	Sets normal/reverse 1	Sets the control action	rv-- (heat (reverse) /cool (none)) no-- (heat (normal) /cool (none)) rvno (heat (reverse) /cool (normal)) norv (heat (normal) /cool (reverse)) rvrv (heat (reverse) /cool (reverse)) nono (heat (normal) /cool (normal))	rv--/rvno (single/dual)	(Note6) RST
⋮	⋮	⋮	⋮	⋮	⋮
"SV7" (SV7)	SV 7	Sets the SV set value	SV limit (lower) (SVL) to SV limit (upper) (SVH) %FS	0%FS	(Note5)
"P7" (P7)	Proportional band 7	Sets the proportional band	0.0 to 999.9%	5.0%	
"i7" (i7)	Integration time 7	Sets the integration time	0 to 3200 sec	240 sec	
"d7" (d7)	Differential time 7	Sets the differential time.	0.0 to 999.9 sec	60.0 sec	
"hyS7" (hyS7)	ON/OFF control hysteresis 7	Sets the hysteresis when using the ON/OFF control.	0 to 50% FS	1 °C	
"CoL7" (CoL7)	Cooling proportional band 7	Sets the cooling proportional band	0.0 to 100.0	1.0	(Note4)

Parameter display symbol	Parameter name	Function	Setting range	Initial value	Remarks
"db7" (db7)	Dead band 7	Sets the dead band	-50.0 to 50.0%	0%	(Note4)
"bAL7" (bAL7)	Output convergence value 7	Offset value which is added to the control output	-100.0 to 100.0%	0/50 (single/dual)	
"Ar7" (Ar7)	Anti-reset windup 7	Sets the anti-reset windup	0 to 100% FS	100% FS	
"rEv7" (rEv7)	Sets normal/reverse 7	Sets the control action	rv-- (heat (reverse) /cool (none)) no-- (heat (normal) /cool (none)) rvno (heat (reverse) /cool (normal)) norv (heat (normal) /cool (reverse)) rvrv (heat (reverse) /cool (reverse)) nono (heat (normal) /cool (normal))	rv--/rvno (single/dual)	(Note6) RST
"SVMX" (SVMX)	Sets the Max SV selection number	Choosing SV with the user key sets it to the maximum possible number.	SV0 SV1 SV2 SV3 SV4 SV5 SV6 SV7 di	SV7	
"PLM" (PLM)	Set the Max PID selection number	Choosing PID with the user key sets it to the maximum possible number.	Pid0 Pid1 Pid2 Pid3 Pid4 Pid5 Pid6 Pid7 di	Pid7	

6-4 / Ramp soak (Ch4)

Create a pattern of temperatures using ramp soak combinations. You can create a temperature pattern with up to 16 steps.

Parameter display symbol	Parameter name	Function	Setting range	Initial value	Remarks
"PTn" (PTn)	Ramp soak operation pattern (Step No.)	Sets which steps to use in the ramp soak operation pattern	0 (uses steps 1 to 4) 1 (uses steps 5 to 8) 2 (uses steps 1 to 8) 3 (uses steps 9 to 12) 4 (uses steps 13 to 16) 5 (uses steps 9 to 16) 6 (uses steps 1 to 16) (according to di)	6	(Note20)
"TiMU" (TiMU)	Ramp soak time units	Sets the units of the ramp soak time	hh.MM (hour:min) MM.SS (min:sec)	hh.MM	
"SV-1" (SV-1)	Ramp soak 1 seg /SV	Sets the SV	0 to 100% FS	0%FS	
"TM1r" (TM1r)	Ramp soak 1 seg ramp time	Sets the ramp time	00.00 to 99.59 (hour:min/min:sec)	00:00 (hour:min)	
"TM1S" (TM1S)	Ramp soak 1 seg soak time	Sets the soak time	00.00 to 99.59 (hour:min/min:sec)	00:00 (hour:min)	
⋮	⋮	⋮	⋮	⋮	⋮
"SV16" (SV16)	Ramp soak 16 seg /SV	Sets the SV	0 to 100% FS	0%FS	
"T16r" (T16r)	Ramp soak 16 seg ramp time	Sets the ramp time	00.00 to 99.59 (hour:min/min:sec)	00:00 (hour:min)	
"T16S" (T16S)	Ramp soak 16 seg soak time	Sets the soak time	00.00 to 99.59 (hour:min/min:sec)	00:00 (hour:min)	
"Mod" (Mod)	Ramp soak mode	Sets the program operation method	0 to 15	0	RST
"Gsok" (Gsok)	Guaranty soak ON/OFF	Sets the guaranty soak ON or OFF	oFF (guaranty soak off) on (guaranty soak on)	oFF	
"GS-L" (GS-L)	Guaranty soak band (lower)	Sets the lower limit of guaranty soak	0 to 50% FS	5°C	
"GS-h" (GS-h)	Guaranty soak band (upper)	Sets the upper limit of guaranty soak	0 to 50% FS	5°C	
"PvST" (PvST)	PV start	Sets whether or not to start ramp soak with PV.	oFF (PV start off) on (PV start on)	oFF	
"ConT" (ConT)	Restore mode	Sets how to restart when the controller is restored after a power loss.	rES (Reset) Con (Continue) ini (Restart)	rES	(Note20)
"PTnM" (PTnM)	Sets the Max pattern selection	Choosing pattern with the user key sets it to the maximum possible number.	0 to 6, di	6	
"PMin" (PMin)	Sets the Min pattern selection	Choosing pattern with the user key sets it to the minimum possible number.	0 to 6, di	0	

6-5 / Monitor (Ch5)

You can check the ramp soak progress, control output, heater current, remaining time, and other status functions.

Parameter display symbol	Parameter name	Function	Setting range	Remarks
"5rP" (STAT)	Ramp soak progress	Displays the progress of the ramp soak	oFF (ramp soak stopped) 1-rP (ramp in step 1) 1-Sk (soak in step 1) ⋮ 16rP (ramp in step 16) 16Sk (soak in step 16) End (ramp soak finished)	
"MV1" (Mv1)	MV1	Displays the output value of the control output (OUT1)	-3.0 to 103.0%	
"MV2" (Mv2)	MV2	Displays the output value of the control output (OUT2)(during dual control)	-3.0 to 103.0%	(Note4)
"rSV" (rSV)	RSV input value display	Displays the input value of the RSV	-5 to 105% FS	(Note1)
"CT1" (CT1)	Heater current 1	Displays the current through the CT	0, 0.4 to 50.0A	(Note10)
"LC1" (LC1)	Leak current value 1	Displays the leak current value of CT.	0, 0.4 to 50.0A	(Note10)
"TM1" (TM1)	Remaining time on timer 1	Displays the remaining time on timer 1	0 to 9999 sec/ 0 to 9999 min	(Note3)
⋮	⋮	⋮	⋮	
"TM3" (TM3)	Remaining time on timer 3	Displays the remaining time on timer 3	0 to 9999 sec/ 0 to 9999 min	
"FALT" (FALT)	Error source display	Displays the source of an error	FALT = □□□□ <div style="border: 1px solid black; padding: 2px; margin: 5px 0;"> fixed at 0 8bit : PV input underflow 9bit : PV input overflow 10bit: underrange 11bit: overrange 12bit: RSV underrange 13bit: RSV overrange 14bit: range setting error 15bit: EEPROM error </div>	
"PLno" (PLno)	Current palette No.	Displays the PID palette No. currently selected.	0 to 7	
"PTno" (PTno)	Current palette No.	Displays the pattern No. of the ramp soak currently selected.	0 to 6	

6-6 / Setup (Ch6)

Sets up the input range, output range, and other items for the equipment.

Parameter display symbol	Parameter name	Function	Setting range	Initial value	Remarks
"PvT" (PvT)	PV input type	Sets the type of input sensor	0 (no function) 1 (PT 100Ω) 2 (J) 3 (K) 4 (R) 5 (B) 6 (S) 7 (T) 8 (E) 9 (no function) 10(no function) 11 (no function) 12 (N) 13 (PL-2) 14 (no function) 15 (0 to 5V / 0 to 20mA) 16 (1 to 5V / 4 to 20mA) 17 (0 to 10V) 18 (2 to 10V) 19 (0 to 100mV)	3 (K)	RST
"Pvb" (Pvb)	PV input lower limit	Sets the lower limit of PV input	-1999 to 9999	0°C	RST
"PvF" (PvF)	PVinput upper limit	Sets the upper limit of PV input	-1999 to 9999	400°C	RST
"Pvd" (Pvd)	Decimal point position	Sets the number of decimal point positions for the PV/SV	0 (No digit after decimal point) 1 (1 digit after decimal point) 2 (2 digit after decimal point)	0	RST
"Pvof" (Pvof)	PV input shift	Sets the amount of shift for PV input	-10 to 10% FS	0%FS	
"TF" (TF)	PV input filter	Sets the time constant for the PV input filter	0.0 to 120.0 sec	5.0 sec	
"rEM0" (rEM0)	RSV Zero adjustment	Adjusts the zero RSV input	-50 to 50% FS	0%FS	(Note1)
"rEMS" (rEMS)	RSV Span adjustment	Adjusts the span RSV input	-50 to 50% FS	0%FS	(Note1)
"rEMr" (rEMr)	RSV input range	Sets the range for RSV input	0-5 (0 to 5V) 1-5 (1 to 5V)	1-5	(Note1)
"rTF" (rTF)	RSV input filter	Sets the time constant for the RSV input filter	0.0 to 120.0 sec	0.0 sec	(Note1)

Parameter display symbol	Parameter name	Function	Setting range	Initial value	Remarks																											
"C1r" (C1r)	OUT1 range	Sets the range of the control output (OUT1)	0-5 (0 to 5V) 1-5 (1 to 5V) 0-10 (0 to 10V) 2-10 (2 to 10V) 0-20 (0 to 20mA) 4-20 (4 to 20mA)	0-10 (voltage) 4-20 (current)	(Note9) (Note13)																											
"C2r" (C2r)	OUT2 range	Sets the range of the control output (OUT2) (Also sets for the re-transmission output)	0-5 (0 to 5V) 1-5 (1 to 5V) 0-10 (0 to 10V) 2-10 (2 to 10V) 0-20 (0 to 20mA) 4-20 (4 to 20mA)	0-10 (voltage) 4-20 (current)	(Note12) (Note13) (Note17)																											
"FLo1" (FLo1)	Output 1 set value during FALT	Sets the output value for the control output (OUT1) during FALT	-3.0 to 103.0%	-3.0%																												
"FLo2" (FLo2)	Output 2 set value during FALT	Sets the output value for the control output (OUT2) during FALT	-3.0 to 103.0%	-3.0%	(Note4)																											
"Sfo1" (Sfo1)	Soft Start output 1 set value	Sets the upper limit value for the control output (OUT1) during soft start	-3.0 to 103.0%	103.0%																												
"SFTM" (SFTM)	Soft Start set time	Sets the time from startup to the finish of soft start	00:00 to 99:59 (hour:min)	0.00 (hour: min)	Be sure to set 0.00 during dual control.																											
"Sbo1" (Sbo1)	OUT1 output set value during standby	Sets the output value for the control output (OUT1) during standby	-3.0 to 103.0%	-3.0%																												
"Sbo2" (Sbo2)	OUT2 output set value during standby	Sets the output value for the control output (OUT2) during standby	-3.0 to 103.0%	-3.0%	(Note4)																											
"SbMd" (SbMd)	Standby mode setting	Sets the alarm output, re-transmission and PV/SV display during standby	<table border="1" style="font-size: small;"> <thead> <tr> <th>ALM display/output</th> <th>Ao output</th> <th>PV/SV display</th> </tr> </thead> <tbody> <tr><td>0 OFF</td><td>ON</td><td>ON</td></tr> <tr><td>1 ON</td><td>ON</td><td>ON</td></tr> <tr><td>2 OFF</td><td>OFF</td><td>ON</td></tr> <tr><td>3 ON</td><td>OFF</td><td>ON</td></tr> <tr><td>4 OFF</td><td>ON</td><td>OFF</td></tr> <tr><td>5 ON</td><td>ON</td><td>OFF</td></tr> <tr><td>6 OFF</td><td>OFF</td><td>OFF</td></tr> <tr><td>7 ON</td><td>OFF</td><td>OFF</td></tr> </tbody> </table>	ALM display/output	Ao output	PV/SV display	0 OFF	ON	ON	1 ON	ON	ON	2 OFF	OFF	ON	3 ON	OFF	ON	4 OFF	ON	OFF	5 ON	ON	OFF	6 OFF	OFF	OFF	7 ON	OFF	OFF	0	(Note14) RST
ALM display/output	Ao output	PV/SV display																														
0 OFF	ON	ON																														
1 ON	ON	ON																														
2 OFF	OFF	ON																														
3 ON	OFF	ON																														
4 OFF	ON	OFF																														
5 ON	ON	OFF																														
6 OFF	OFF	OFF																														
7 ON	OFF	OFF																														
"AoT" (AoT)	Types of AO output	Selects the types of re-transmission output	PV SV MV DV	Pv	(Note12)																											
"AoL" (AoL)	AO lower limit scaling	Sets the lower limit of AO	-100 to 100%	0%	(Note12)																											
"Aoh" (Aoh)	AO upper limit scaling	Sets the upper limit of AO	-100 to 100%	100%	(Note12)																											

6-7 / System (Ch7)

Assigns the functions of the DI/DO, LED lamp, and other controls.

Parameter display symbol	Parameter name	Function	Setting range	Initial value	Remarks
"UKEy" (UKEy)	Assigns the USER key	Sets the function of the [USER] key	0 (no function) 1 (Switchover between STBY ON/OFF) 2 (Switchover between Auto/Manual) 3 (Switchover between Local/Remote) 4 (no function) 5 (Starts AT (standard)) 6 (Starts AT (low PV)) 7 (Ramp SV on/off) 8 (Ramp SV HOLD) 9 (Ramp soak RUN/OFF) 10 (Ramp soak RUN/HOLD) 11 (no function) 12 (Latch release (all)) 13 (Latch release (DO1)) 14 (Latch release (DO2)) 15 (Latch release (DO3)) 16 (Latch release (DO4)) 17 (Latch release (DO5)) 18 (Start timer (DO1)) 19 (Start timer (DO2)) 20 (Start timer (DO3)) 21 (Start timer (DO4)) 22 (Start timer (DO5)) 23 (SV No. + 1 (send)) 24 (PID No. + 1 (send)) 25 (no function) 26 (Ramp soak pattern No. + 1 (send)) 27 (SV No. + 1, PID No. + 1 (send))	2	RST

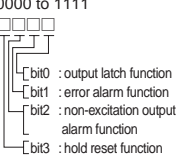
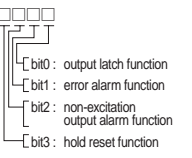
Parameter display symbol	Parameter name	Function	Setting range	Initial value	Remarks
"dC # " (diI)	DI-1 function selection	Sets the function of DI-1	0 (No function) 1 (Switchover between STBY ON/OFF) 2 (Switchover between Auto/Manual) 3 (Switchover between Local/Remote) 4 (No function) 5 (No function) 6 (Start AT (standard)) 7 (Start AT (low PV)) 8 (No function) 9 (No function) 10 (Ramp SV ON/OFF) 11 (Ramp SV HOLD) 12 (Ramp soak OFF) 13 (Ramp soak RUN/HOLD) 14 (No function) 15 (Latch release (all)) 16 (Latch release (DO1)) 17 (Latch release (DO2)) 18 (Latch release (DO3)) 19 (Latch release (DO4)) 20 (Latch release (DO5)) 21 (Start timer (DO1)) 22 (Start timer (DO2)) 23 (Start timer (DO3)) 24 (Start timer (DO4)) 25 (Start timer (DO5)) 26 (SV No. + 1) 27 (SV No. + 2) 28 (SV No. + 4) 29 (PID No. + 1) 30 (PID No. + 2) 31 (PID No. + 4) 32 (No function) 33 (No function) 34 (No function) 35 (SV No.+1, PID No.+1) 36 (SV No.+2, PID No.+2) 37 (SV No.+4, PID No.+4) 38 (Pattern No.1) 39 (Pattern No.+2) 40 (Pattern No.+4) 41 (Soft start) 42 (Ramp soak RUN) 43 (Ramp soak HOLD) 44 (Ramp soak RUN at DO1 startup) 45 (Ramp soak RUN at DO2 startup) 46 (Ramp soak RUN at DO3 startup) 47 (No function) 48 (No function)	0	(Note1) RST
⋮	⋮	⋮	⋮	⋮	⋮
"dC3 " (di3)	DI-3 function selection	Sets the function of DI-3	0 to 48	0	
"do # " (do1T)	Sets the DO1 output event type	Sets the function of DO1	0 to 102	0	(Note3) RST
"doP # " (doP1)	Sets DO1 option function	Assigns the four types of option functions in bit units	0000 to 1111 	0000	
⋮	⋮	⋮	⋮	⋮	⋮
"do3T " (do3T)	Sets the DO3 output event type	Sets the function of DO3	0 to 102	0	
"doP3 " (doP3)	Sets DO3 option function	Assigns the four types of option functions in bit units	0000 to 1111 	0000	
⋮	⋮	⋮	⋮	⋮	⋮
"r-rP " (rMP)	ramp SV ON/OFF	Sets the ramp SV ON/OFF	oFF (ramp SV OFF) on (ramp SV ON)	on	
"r-rPL " (rMPL)	Ramp SV-Divide	Sets the slope for a falling SV during ramp SV operations	0 to 100% FS	0°C	
"r-rPh " (rMPH)	Ramp SV-Incline	Sets the slope for a rising SV during ramp SV operations	0 to 100% FS	0°C	
"r-rPU " (rMPU)	Ramp SV-slope units of time	Sets the unit of time for the slope during ramp SV operations	hoUr (slope temperature/hour) Min (slope temperature/min)	hoUr	
"SvT " (SvT)	Ramp SV - SV display mode selection	Displays the SV during ramp operations or the SV goal value on the SV display	rMP (SV during ramp) TrG (target SV)	rMP	
"CTrL " (CTrL)	Control methods	Allows you to select the control method.	Pid (PID control) FUZY (Fuzzy PID control) SELF (Self-tuning control) Pid2 (PID2 control)	Pid	Sections 7-1 to 7-5 (Note18) RST

Parameter display symbol	Parameter name	Function	Setting range	Initial value	Remarks
"STMd " (STMd)	Start mode	Sets the operation mode when starting up	Auto (auto mode startup) Man (manual mode startup) Rem (remote mode startup) STBy (Standby make startup)	AUTO	

6-8 / Alarm (Ch8)

Sets the detect conditions for each type of alarm.

Parameter display symbol	Parameter name	Function	Setting range	Initial value	Remarks
"ALM1 " (A1hy)	ALM1 hysteresis	Sets the hysteresis for alarm output 1 ON/OFF	0 to 50% FS	1°C	(Note3)
"dLY1 " (dLY1)	ALM1 delay	Sets the delay before detecting alarm output 1	0 to 9999 [sec/min]	0 (sec/min)	
"dL1U " (dL1U)	ALM1 delay time units	Sets the delay time units for alarm output 1	sec (second) Min (minute)	sec	
⋮	⋮	⋮	⋮	⋮	⋮
"ALM3 " (A3hy)	ALM3 hysteresis	Sets the hysteresis for alarm output 3 ON/OFF	0 to 50% FS	1°C	
"dLY3 " (dLY3)	ALM3 delay	Sets the delay detecting for alarm output 3	0 to 9999 [sec/min]	0 (sec/min)	
"dL3U " (dL3U)	ALM3 delay time units	Sets the delay time units for alarm output 3	sec (second) Min (minute)	sec	
"hb # " (hb1)	HB alarm set value for CT	Sets the heater burnout alarm detection value for CT	0.0 to 50.0A	0.0A	(Note10)
"hb #h " (hb1h)	HB alarm hysteresis for CT	Sets the heater burnout alarm ON/OFF hysteresis for CT	0.0 to 50.0A	0.5A	(Note10)
"hS # " (hS1)	Load short-circuit alarm setting value for CT	Sets the heater load short-circuit alarm setting value for CT.	0.0 to 50.0A	0.0A	
"hS #h " (hS1h)	Load short-circuit alarm hysteresis for CT	Sets the heater load short-circuit alarm ON/OFF hysteresis for CT.	0.0 to 50.0A	0.5A	
"LbTM " (LbTM)	Loop break detection time	Sets the time before detecting a broken loop	0 to 9999 sec	0 sec	
"LbAb " (LbAb)	Loop break detection range (°C)	Sets the temperature range before detecting a broken loop	0 to 100% FS	10°C	

6-9 / Communication (Ch9)

Sets the communication conditions towards the host computer.

Parameter display symbol	Parameter name	Function	Setting range	Initial value	Remarks
"STno " (Stno)	ST No. setting	Sets the station number.	0 to 255 (0: unresponsive communication)	1	(Note15)
"CoM " (CoM)	Baud rate/Parity setting	Sets the baud rate and parity check	96od (9600 bps/odd) 96Ev (9600 bps/even) 96no (9600 bps/none) 19od (19200 bps/odd) 19Ev (19200 bps/even) 19no (19200 bps/none)	96od	(Note15) RST
"SCC " (SCC)	Communication permissions	Sets whether or not overwriting is possible from the master side (PC, etc.)	r (read only permission) rW (read and overwrite permission)	rW	(Note15)

6-10 / PFB (Ch10)

Changes settings to use valve control.

Parameter display symbol	Parameter name	Function	Setting range	Initial value	Remarks
"PGAP " (PGAP)	PFB dead band	Sets the PFB dead band	0.0 to 100.0%	5%	(Note8)
"TrVL " (TrVL)	Valve stroke time	Sets the full stroke time for the valve	5 to 180 sec	30 sec	(Note8)

6-11 / Password Setup (Ch11)

Sets the password. Passwords can be set at three levels.

Display	Parameter name	Function	Setting range	Initial value	Remarks
"PAS1 " (PAS1)	Password1 setup	Sets password 1.	0000 to FFFF	0000	
"PAS2 " (PAS2)	Password2 setup	Sets password 2.	0000 to FFFF	0000	
"PAS3 " (PAS3)	Password3 setup	Sets password 3.	0000 to FFFF	0000	

Sets the parameter mask function Optional parameters can be set not to display. For details on the parameter mask function, refer to the "Operation Manual".

Display	Parameter name	Function	Setting range	Initial value	Remarks
"dP01" (dP01)	Parameter mask of each parameter	Sets the parameters to be displayed/not displayed.	0000 to FFFF	Value different depending on the model code	
⋮	⋮	⋮	⋮	⋮	⋮
"dP30" (dP30)	Parameter mask of each parameter	Sets the parameters to be displayed/not displayed.	0000 to FFFF	Value different depending on the model code	

- Note 1: Displayed when the seventh digit of the model code is H, K, F, or 2.
- Note 2: Displayed when the ninth digit of the model code is not 0.
- Note 3: Display changes according to the DO number and the selected alarm type.
- Note 4: Displayed when the seventh digit of the model code is A, C, E or P.
- Note 5: "SvL" and "SvH" must be set so that SvL < SvH.
When the setting values of "SvL" and "SvH" are changed, check SV setting value 4 ("SvL" [h3]) through SV setting value 7 ("SvH" [h3]).
- Note 6: Set the same value as the one for the Normal/Reverse setting ("rEv" [h2]).
- Note 7: Displayed when the fifth digit of the model code is A or C.
- Note 8: Displayed when the fifth digit of the model code is S.
- Note 9: Displayed when the fifth digit of the model code is E or P.
- Note 10: Displayed when the seventh digit of the model code is G or J.
- Note 11: The number of parameters to be displayed varies depending on the number of DI that PXG has.
For more details on "41: DI soft start", refer to the "Operation Manual".
- Note 12: Displayed when the sixth digit of the model code is R or S.
- Note 13: Select the proper setup range for the output type.
- Note 14: Do not set 4-7.
- Note 15: Displayed when the seventh digit is M, V, K, J or F.
- Note 16: Displayed when the sixth digit of the model code is A or C.
- Note 17: Displayed when the sixth digit of the model code is E or P.
- Note 18: When the fifth digit of the model code is S, be sure to select PID control. Options other than PID control cannot be used.
- Note 19: When changing the SV with the front key, do not change the "SvH" parameter via communication.
Otherwise, the changed SV may not be stored correctly.
- Note 20: Do not change this parameter during the ramp soak operation.
Be sure to set "rEv" = "off" before changing the parameter.

7 Functions

This controller has five types of temperature control functions and one type of valve control functions. Select according to type and use.

Caution The ramp soak function (□ page 12), remote SV function (□ page 15), and SV selection function (□ page 16) cannot be combined.

● Temperature Control Functions

ON/OFF (2-position) control	Turns the control output ON/OFF according to the size relationship of PV and SV. Can build a control system out of simple elements such as SSR. Suitable when accuracy is not requested.	□ 7-1 (page 10)
PID Controls	PID calculation and controls proceed according to the previously set PID parameters. PID parameters can be set manually or through auto-tuning (AT). It is the most basic control in this equipment.	□ 7-2 (page 10)
Fuzzy PID Control	PID control with function that reduces the amount of overshoot during control. It is effective when you want to suppress overshoot when SV is changed, even if you may take a long time to reach the target value.	□ 7-3 (page 10)
Self-tuning Control	Automatically calculating PID control according to the control target or SV change. It is effective when the control conditions change frequently.	□ 7-4 (page 10)
PID2 Control	In case which the power supply of the control target goes ON → OFF → ON, this PID2 control can suppress the amount of overshoot during control target turns OFF → ON.	□ 7-5 (page 11)

● Valve Control Functions

Servo Control 1 (Servo 1)	Regulates the valve position according to [OPEN] and [CLOSE] of the contact output.	□ 7-7 (page 11)
---------------------------	---	-----------------

Acts as an ON/OFF control when the PID parameter is set to "P" = 0.0 ("P" [h 2]). ON/OFF control switches the control output to ON (100%) or OFF (0%) according to the size relationship of PV and SV. The output hysteresis can be set under the parameter "hys" ("P" [h 2]).

Reverse Operation (heat control)

Method used to control the electrical heating furnace. Set the "hys" to an appropriate value according to the control target.

Parameter	Set Value
"P"	0.0
"rEv"	rv--
"hys"	arbitrary (factory setting: 1 °C)

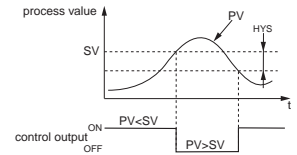

Normal Operation (cooling control)

Method used to control the cooling machine.

Parameter	Set Value
"P"	0.0
"rEv"	no--
"hys"	arbitrary (factory setting: 1 °C)

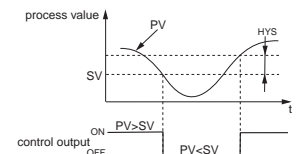

Point

- During ON/OFF control, the I and D settings do not affect control.
- The manual operation during ON/OFF control will become MV=100% when the [MAN] key is pressed, and MV=0% when the [STOP] key is pressed.
- If the hysteresis width is narrow, and PV and SV are nearly equal, the output may frequently switch ON and OFF. Note that it may affect the operation life of the contact output.

7-2 / PID Controls

PID controls run as long as the parameter is set to "P" ≠ 0.0 ("P" [h 2]) and "Ctrl" = PID ("SvS" [h 2]). The PID controls calculate PID based on the set values for parameters "P", "I", "D", and "R", and output the calculated result (-3% to 103%).

Each parameter can be set either by manually tuning the values or by running auto-tuning (AT) to automatically set the values.

Refer to □ For more details on auto-tuning, see "7-6 Auto-tuning" (page 11)

Setting PID Control

- 1 Display the system menu ("SvS" [h 2]).
- 2 Display the control parameter ("Ctrl") and choose PID controls ("PID").
- 3 Press the [SET] key to set the value.

7-3 / Fuzzy PID Control

Related to normal PID controls, fuzzy PID control acts with small overshoot. You will need to run auto-tuning to set the PID parameter when using fuzzy control.

Setting fuzzy PID control

- 1 Display the system menu ("SvS" [h 2]).
- 2 Display the controller parameter ("Ctrl") and choose fuzzy ("Fuzzy").
- 3 Press the [SET] key to set the value.

Refer to □ For more details on auto-tuning, see "7-6 Auto-tuning" (page 11)

7-4 / Self-tuning Control

Self-tuning Control is a control which automatically calculate the value of PID, under the condition that the control target or set value (SV) changes. Self-tuning is especially effective for situations when a high level of control is not needed, but auto-tuning cannot be run due to frequent changes in the control target conditions.

Point

When a high level of control is required, choose PID control, fuzzy PID control, or PID2 control.

Conditions where self-tuning can be used

Self-tuning is used in the following situations:

- When temperature rises when the power is turned on
- When temperature rises when SV changes (or when the controller decides it is necessary)
- When the controller decides it is necessary because the controls have become unstable

Conditions where self-tuning cannot be used

Self-tuning cannot be used in the following situations:

- During control standby
- During ON/OFF (2-position) control
- During auto-tuning
- During ramp soak progress
- When there is error input
- When set for dual output
- When any of the P, I, D, Ar parameters are set to manual
- During manual mode
- During soft start progress

Conditions to halt self-tuning

Halt self-tuning in the following situations:

- When there is a change in SV (This includes the case where SV changes because of the ramp soak function, remote SV function, or ramp SV.)
- When self-tuning has not finished after running for nine or more hours

Setting self-tuning

- 1 Turn on power of the controller and set the SV.
- 2 Display the system menu ("595 Ch 7").
- 3 Display the controller parameter ("Ctrl") and choose self-tuning ("SELF").
- 4 Press the key to set the value.
- 5 Turn off power of the controller.
- 6 Turn on power of the control target equipment and the controller. Turn on power of the control equipment first. Self-tuning will begin.

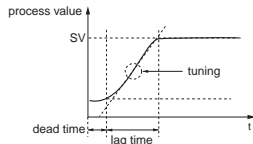

- Point**
- The equipment will not tune correctly if power of the controller is turned on first.
 - To reset self-tuning, set the control method to PID ("PID") once before changing back to self-tuning.

7-5 / PID2 Control

In case which the power supply of the control target goes ON → OFF → ON, this PID2 control can suppress the amount of overshoot.

This control introduces an algorithm to prevent the calculated PID result from becoming a miscalculation, even when the control loop is open.

You will need to run auto-tuning to set the PID parameter when using PID2 control.

- Features of PID2 Control

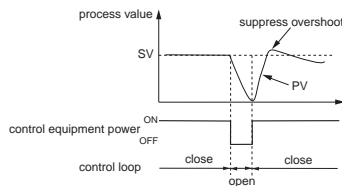

Setting PID2 control

- 1 Display the system menu ("595 Ch 7").
- 2 Display the control parameter ("Ctrl") and choose PID2 ("PID2").
- 3 Press the key to set the value.

7-6 / Auto-tuning

Run auto-tuning to set the PID parameter automatically.

"PF" set value	Behavior	Function
"OFF"	Stop/Finish	Stops or finishes auto-tuning.
"on"	Normal type	The standard auto-tuning for SV reference. Choose this auto-tuning in most situations.
"Lo"	Low PV type	Auto-tuning for SV-10% reference. Choose this when you want to suppress the overshoot when tuning.

• Normal type

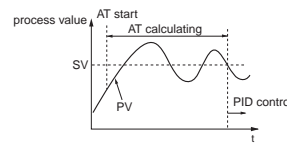

• Low PV type

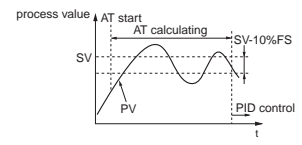

Point

- Set the following parameters before running auto-tuning.
- PV input type / PV input upper limit / PV input lower limit / Decimal position / PV input filter in the setup channel menu ("5EF Ch 6")
 - OUT1 proportion cycle (OUT2 proportion cycle) in the PID channel menu ("PID Ch 2").

Running auto-tuning

- 1 Display the operation menu ("oPE Ch 1").
- 2 Display auto-tuning ("RF") and choose the tuning type. Choose the standard type ("on") or low PV type ("Lo") according to the control target.
- 3 Press the key to start auto-tuning. A decimal point will blink at the bottom of the display during auto-tuning. When auto-tuning has successfully completed, blinking decimal point will turn off and overwrites the PID.

Point

- PID parameter which is set after auto tuning has finished normally will be maintained even when the power is turned off. However, the PID value will not be changed if the power is turned off during auto-tuning. In this case, rerun auto-tuning.
- The equipment will use ON/OFF (2 position) control during auto-tuning, so there may be a large change in PV according to the process. Do not use auto-tuning for processes that do not permit a large change in PV. Do not use auto-tuning for processes such as pressure control and flow control that have a fast response.
- Auto-tuning is not behaving normally if it has not finished after four or more hours have passed. In these cases, recheck parameters such as input/output wiring, control output behavior (normal/reverse), and input sensor type.
- Rerun auto-tuning if there is a large change in SV, a change in the PV input type, or a change in the control target conditions that reduces the effectiveness of the controls.
- You can run auto-tuning when the control type is set to "fuzzy" or "PID2".
- You cannot run auto-tuning in manual mode.
- When using the PID selection function, the auto-tuning result for the selected PID group is stored.
- Auto tuning is forcibly terminated when SV changes because of the ramp soak function, remote SV function, or ramp SV.

7-7 / Valve Control (Servo Control 1)

Valve controls adjust and control the valve position according to [OPEN] and [CLOSE] of the contact signal.

Turn on the contact outputs in manual mode, so that pressing the key means "OPEN", and pressing the key means "CLOSE"

Note: Srv2 or PFB cannot be used in PXG4.

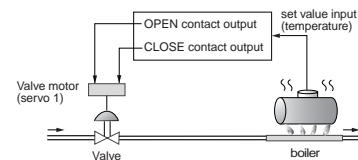

Setting Servo Control 1

- 1 Display the system menu ("595 Ch 7").
- 2 Display the control parameter ("PrCS") and choose servo control 1 ("Srv1"). This chooses "Servo Control 1".
- 3 Press the key to set the value.

Point

An interlock function is not built in.

Caution

Chattering may occur if the dead band ("PGAP") in the PFB menu ("PFB Ch 10") is set too small.

Setting the valve stroke time

The valve stroke time must be set to use valve control.

- 1 Display the PFB menu ("PFB Ch 10").
- 2 Display the valve stroke time parameter ("TrUL") and set the stroke time for the valve in use.
- 3 Press the key to set the value.

7-8 / Manual Output

Allows the control output to be manually set at an arbitrary value.

- Manual Mode Display
 - A decimal point will light up at the bottom right of the display during manual mode.
 - The same decimal point appears on the parameter setting display.
- Switchover between Auto and Manual
 - Modes can be changed by four methods: the front key (user key), DI function, communication function, or the parameter "MAN" ("oPE [h i]).
- MV output flow diagram (MV output priority processing)

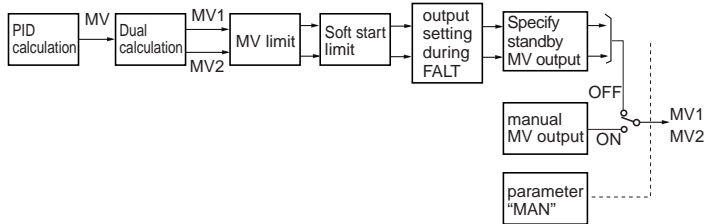

Caution • MV limit does not apply to the MV output during manual operation, FALT, or standby. (Take extra caution when MV performs flash protection during combustion control by using the overlimit function.)

7-9 / Ramp Soak Function

Automatically runs after setting the times for the SV changes. You can choose up to sixteen steps for the SV setting and seven types of ramp soak operation patterns.

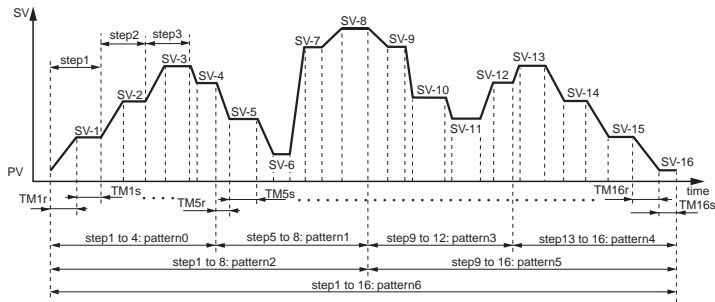

Caution • When using the system in the restore mode ("Conr") = continue ("Con") in the ramp/soak menu ("PrG [h4]"), do not set the ramp/soak control command ("PrG") of the operation menu ("oPE [h i]") to hold ("hLd") during the ramp period at the beginning of the pattern.
 • When PV start ("PvSt") of the ramp/soak menu ("PrG [h4]") is on ("on"), set the pattern parameter ("Prn") of ramp/soak ("PrG [h4]") to "Prn" = 0, 2, 6 (setting that starts with 1 seg ramp).
 • Do not set the Startup mode ("Stfbd") = standby mode ("Stfbd") of the system menu ("SbS [h7]) and the restore mode ("Conr") = continue ("Con") of the ramp/soak menu ("PrG [h4]") at the same time.

Creating a ramp soak operation pattern

Set the following items to create a pattern.

Pattern	Sets which steps to use from the following seven types. Steps 1 to 4 / Steps 5 to 8 / Steps 9 to 12 / Steps 13 to 16 / Steps 1 to 8 / Steps 9 to 16 / Steps 1 to 16
Target SV	Sets the controlled temperature.
Ramp time	Sets the time to reach the target SV from the current SV.
Soak time	Sets the time to maintain the specified SV.

The following steps will explain how to run the specified pattern 0 in SV-1 to SV-4.

- 1 Display the ramp soak menu ("PrG [h4]").
- 2 Display pattern parameter ("Prn") and choose pattern 0 ("0"). Run SV-1 through SV-4.
- 3 Display the time parameter ("TmS") and choose minute:second ("mSs"). Sets the units of time. Besides minute:second ("mSs"), you can also choose hour:minute ("hMm").
- 4 Display the target value ("Sv-i") and set the target temperature.
- 5 Display the ramp time parameter ("Tm1r") and set the ramp time.
- 6 Display the soak time parameter ("Tm1s") and set the soak time.
- 7 Repeat steps 4 through 7 and set the remaining parameters.

Running ramp soak

The following steps explain how to run ramp soak.

- 1 Display the operation menu ("oPE [h i]).
- 2 Display program parameter ("PrG") and choose RUN ("rUn").
- 3 Ramp soak starts running from the current PV.

Point • To interrupt the ramp soak operation, choose HOLD ("hLd") in step 2. To cancel the interruption, choose RUN ("rUn") again.
 • "End" will display when ramp soak has completed.

Guaranty soak

This function guarantees the soak time. Only soak time within the specified range of temperature for SV is counted towards soak time. As seen in the figure below, only the sum of the shaded areas is counted as soak time. The operation moves onto the next step when the total soak time equals the specified soak time.

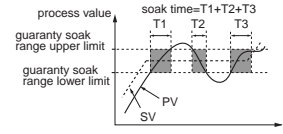

The following steps will explain how to set an example guaranty soak range with an upper limit of 5°C and a lower limit of 3°C.

- 1 Display the ramp soak menu ("PrG [h4]).
- 2 Display guaranty ON/OFF parameter ("G5ot") and choose on ("on").
- 3 Display the guaranty soak lower limit parameter ("G5-L") and set the lower limit (in this example, set it to 3°C).
- 4 Display the guaranty soak upper limit parameter ("G5-h") and set the upper limit (in this example, set it to 5°C).
- 5 Press the key to set the value.

Mode setting

Sets how you want to run ramp soak.

The following items can be set.

Power On Start	Ramp Soak starts running from the current PV.
Ending Output	Shows the ending output after ramp soak has been completed.
OFF Output	Shows the output during OFF after ramp soak has been completed.
Repeat Behavior	After finishing the last step in ramp soak, the process starts again from 1st step.

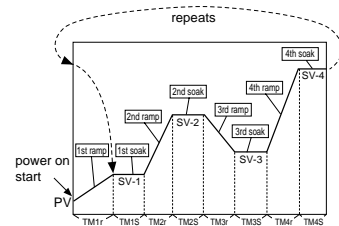

You can choose from the following 16 types of modes according to the combination of run method options.

Setting	Power On Start	Ending Output	OFF Output	Repeat Behavior
"0"	Off	Continuous control	Continuous control	Off
"1"	Off	Continuous control	Continuous control	On
"2"	Off	Continuous control	Standby	Off
"3"	Off	Continuous control	Standby	On
"4"	Off	Standby	Continuous control	Off
"5"	Off	Standby	Continuous control	On
"6"	Off	Standby	Standby	Off
"7"	Off	Standby	Standby	On
"8"	On	Continuous control	Continuous control	Off
"9"	On	Continuous control	Continuous control	On
"10"	On	Continuous control	Standby	Off
"11"	On	Continuous control	Standby	On
"12"	On	Standby	Continuous control	Off
"13"	On	Standby	Continuous control	On
"14"	On	Standby	Standby	Off
"15"	On	Standby	Standby	On

Delay start

Ramp soak can be automatically started (RUN) after a certain period of time has elapsed since the power of the controller is turned on. This function is enabled by setting the digital input function (DI n) and the digital output function (DO n), and setting the delay time to set with dLYn.

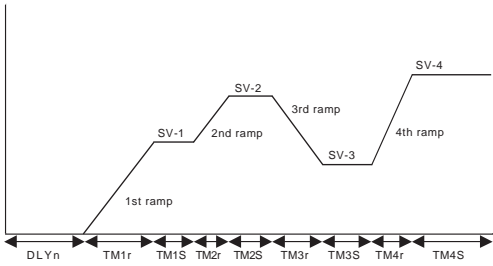

The following steps will explain how to assign the delay start to DI 1, DO1 and to set the delay time to five minutes.

- 1 Display the system menu (SYS CH?).
- 2 Display the DI1 function selection ("dL1"), and set 44 ("44").
- 3 Display the DO1 output event type setting ("do if"), and set 35 ("35").
- 4 Display the Alarm menu (ALM CH?).
- 5 Display the ALM1 delay time ("dLY1"), and set 5 ("5").
- 6 Display the ALM1 delay time unit ("dLYU"), and set the minute ("min").

PV start

When the ramp soak starts (RUN), this function searches the first point where the measurement value (PV) and the program pattern match, and starts operation at that point.

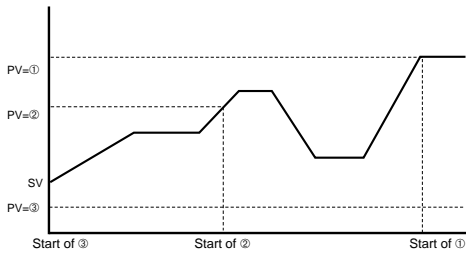

If the measurement value does not match the pattern as with PV=③, the normal operation starts.

7-10 / Digital Input Function

Each of the digital inputs (DI1 to DI3) can be assigned the following functions. The specified function will run when an external DI signal enters the input.

Display	Function Name	Behavior	ON	OFF	Judgment condition
"0"	No function	Nothing happen	-	-	-
"1"	Switchover between standby ON/OFF	Switches between standby on and off	Standby	Standby Cancel	Edge
"2"	Switchover between auto/manual	Switches between auto and manual control output	Manual	Auto	Edge
"3"	Switchover between local/remote	Switches between local and remote SV	Remote	Local	Edge
"4"	No function	Do not set	-	-	-
"5"	No function	Do not set	-	-	-
"5"	Auto-tuning (standard) Start	Starts standard auto-tuning	Start	Finish	Edge
"7"	Auto-tuning (low PV) Start	Starts low PV auto-tuning	Start	Finish	Edge
"8"	No function	Do not set	-	-	-
"9"	No function	Do not set	-	-	-
"10"	Ramp SV on/off	Enables or disables ramp SV.	Disable	Enable	Edge
"11"	Ramp SV HOLD	Switches between ramp SV HOLD and HOLD cancel	HOLD	HOLD cancel	Edge
"12"	Ramp Soak OFF	Turns ramp soap off	OFF	-	Edge
"13"	Ramp Soak RUN/HOLD	Switches between RUN and HOLD.	RUN	HOLD	Edge
"14"	No function	Do not set	-	-	-
"15"	Latch release (all)	Cancel all of the sources currently acting as latches.	-	-	Edge
"15"	Latch release (DO1)	Cancel the source currently acting as a latch on DO1.	Cancel	-	Edge
"17"	Latch release (DO2)	Cancel the source currently acting as a latch on DO2.			
"18"	Latch release (DO3)	Cancel the source currently acting as a latch on DO3.			
"19"	No function	Do not set	-	-	-
"20"	No function	Do not set	-	-	-

Display	Function Name	Behavior	ON	OFF	Judgment condition
"21"	Start timer (DO1)	Starts the specified timer for DO1.	Timer ON	Timer OFF	Level
"22"	Start timer (DO2)	Starts the specified timer for DO2.			
"23"	Start timer (DO3)	Starts the specified timer for DO3.			
"24"	No function	Do not set	-	-	-
"25"	No function	Do not set	-	-	-
"26"	SV No. + 1	When selecting SV No., increases the SV No. by 1.	+1	-	Level
"27"	SV No. + 2	When selecting SV No., increases the SV No. by 2.	+2	-	Level
"28"	SV No. + 4	When selecting SV No., increases the SV No. by 4.	+4	-	Level
"29"	PID No. + 1	When selecting PID No., increases the PID No. by 1.	+1	-	Level
"30"	PID No. + 2	When selecting PID No., increases the PID No. by 2.	+2	-	Level
"31"	PID No. + 4	When selecting PID No., increases the PID No. by 4.	+4	-	Level
"32"	No function	Do not set	-	-	-
"33"	No function	Do not set	-	-	-
"34"	No function	Do not set	-	-	-
"35"	SV No.+1, PID No.+1	When selecting SV No. and PID No., increases the SV No. and PID No. by 1.	+1	-	Level
"36"	SV No.+2, PID No.+2	When selecting SV No. and PID No., increases the SV No. and PID No. by 2.	+2	-	Level
"37"	SV No.+4, PID No.+4	When selecting SV No. and PID No., increases the SV No. and PID No. by 4.	+4	-	Level
"38"	Pattern No.+1	When selecting pattern No., increases the Pattern No. by +1	+1	-	Level
"39"	Pattern No.+2	When selecting pattern No., increases the Pattern No. by +2	+2	-	Level
"40"	Pattern No.+4	When selecting pattern No., increases the Pattern No. by +4	+4	-	Level
"41"	Soft start	Starts the soft start	Soft start ON	-	Edge
"42"	Ramp soak RUN	Sets the ramp soak to RUN.	RUN	-	Edge
"43"	Ramp soak HOLD	Sets the ramp soak to HOLD.	HOLD	-	Edge
"44"	Delay start(DO1)	Enables delay start with the delay time = dLY1.	Delay start enable	-	-
"45"	Delay start(DO2)	Enables delay start with the delay time = dLY2.	Delay start enable	-	-
"46"	Delay start(DO3)	Enables delay start with the delay time = dLY3.	Delay start enable	-	-
"47"	No function	Do not set this.	-	-	-
"48"	No function	Do not set this.	-	-	-

The following steps will explain an example of how to set DI1 to switchover between standby ON/OFF.

- 1 Display the system menu ("SYS CH?").
- 2 Display the DI1 parameter ("dL1") and choose 1 ("1"). This chooses to switchover between standby ON and OFF.
- 3 Press the **SET** key to set the value.

Caution

When "Switchover between local and remote" (DI setting value =3) is used for the digital input function, the operation before turning off the power of the main unit affects the DI operation when the power turns on again. (For the DI operation when the power turns on under each state, see the table below.)

No.	Operation before turning off power of the main unit		DI status while the power of the main unit is on	DI behavior while the power of the main unit is on
	Operation	Operation status		
1	DI On when rEM parameter = LoCL	Remote SV operation	DI On	Remote SV operation
			DI Off	Local SV operation
2	Switches to rEM parameter = rEM by key operation	Remote SV operation	DI On	Remote SV operation
			DI Off	Remote SV operation
3	Switches desired parameter setting value via communication during rEM parameter = rEM	Remote SV operation	DI On	Remote SV operation
			DI Off	Remote SV operation
4	DI Off when rEM parameter = rEM	Remote SV operation	DI On	Remote SV operation
			DI Off	Remote SV operation
5	Switches to rEM parameter = LoCL by key operation	Local SV operation	DI On	Remote SV operation
			DI Off	Local SV operation
6	Switches desired parameter setting value via communication during rEM parameter = LoCL	Local SV operation	DI On	Remote SV operation
			DI Off	Local SV operation

Each of DO1 to DO3 can be assigned the following functions (events). The functions are divided into two categories for when they behave as alarms and when they behave as events.

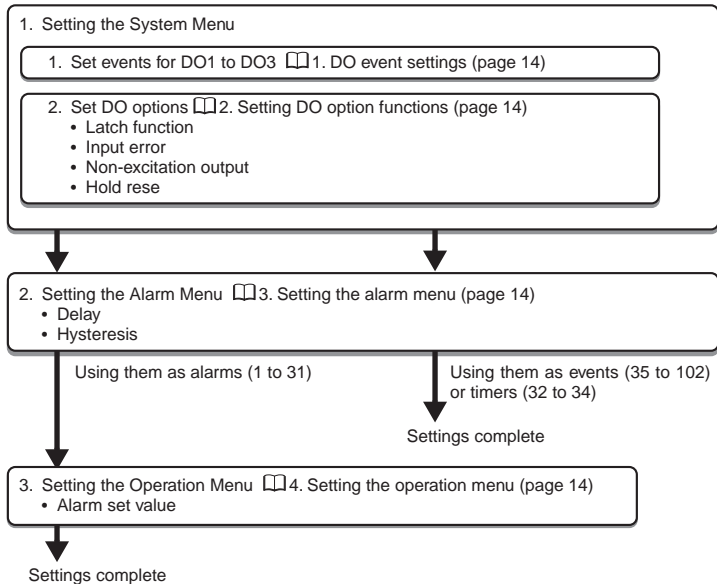

1. DO event settings

Events are divided into those related to alarms and those not related. For more about the events related to alarms, see "11. Alarm Action Type Codes" (page 18). Use the following steps events other than alarms.

- Ramp soak delay start

Type	Setting (DO1 to DO3)	Function
Ramp soak delay start	35	Delay start enable

- Wire burnout circuit alarm

Type	Setting (DO1 to DO3)	Function
Wire burnout circuit alarm	41	Loop break alarm 1
	44	Heater burnout alarm 1
Wire break/short circuit alarm	47	Load short-circuit alarm

- Conditional outputs

Type	Setting (DO1 to DO3)	Function
Conditional outputs	51	During auto-tuning
	52	Normal
	53	During standby
	54	During manual SV operation
	55	During remote SV operation
	56	During ramp SV
Ramp Soak Event Output	60	OFF state
	61	RUN state
	62	HOLD state
	63	GS (Guaranty Soak) State
	65	END state

Type	Setting (DO1 to DO3)	Function
Time Signal	71	Time signal (1st segment)
	72	Time signal (2nd segment)
	73	Time signal (3rd segment)
	74	Time signal (4th segment)
	75	Time signal (5th segment)
	76	Time signal (6th segment)
	77	Time signal (7th segment)
	78	Time signal (8th segment)
	79	Time signal (9th segment)
	80	Time signal (10th segment)
	81	Time signal (11th segment)
	82	Time signal (12th segment)
	83	Time signal (13th segment)
	84	Time signal (14th segment)
	85	Time signal (15th segment)
	86	Time signal (16th segment)
	87	Time signal (17th segment)
	88	Time signal (18th segment)
	89	Time signal (19th segment)
	90	Time signal (20th segment)
	91	Time signal (21st segment)
	92	Time signal (22nd segment)
	93	Time signal (23rd segment)
	94	Time signal (24th segment)
	95	Time signal (25th segment)
	96	Time signal (26th segment)
	97	Time signal (27th segment)
	98	Time signal (28th segment)
	99	Time signal (29th segment)
	100	Time signal (30th segment)
	101	Time signal (31st segment)
	102	Time signal (32nd segment)

Use the following steps to set DO.

- 1 Display the system menu ("595 Ch 7").
- 2 Set the event you want to specify under the DO1 output event setting type ("do if").
- 3 Set the option function under the DO1 option function parameter ("doP"). For the contents of this setting, see "2. Setting DO option functions" below.
- 4 Set DO2 to DO3 as necessary.
- 5 Press the **SEL** key to set the value.

2. Setting DO option functions

Allows you to set not just even settings, but option functions for each DO.

The DO events are set by each digit.

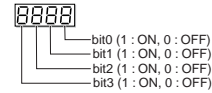

bit	Function	Description
bit0	Event output latch function	Latches (maintains) the DO when the event starts
bit1	Error alarm function	Outputs when the unit receives an input error ("UUUU" or "LLLL" is displayed). Set DO event to "0" when using this function.
bit2	Non-excitation output alarm function	Reverses the output signal and outputs it through the DO terminal when the event starts
bit3	Hold reset function	When using an alarm with hold, the hold function will reset when any of the following operations occur: SV change / Alarm type change / Alarm set value change / Standby cancel / Power reset

3. Setting the alarm menu

- Hysteresis Function
The hysteresis band is preserved during alarm output.
- Delay Function
When events (including alarms) occur, the DO does not begin outputting immediately. Instead, the event continues for a specified period of time before outputting DO. This is called a delay function because there is a delay between the event and outputting to DO.

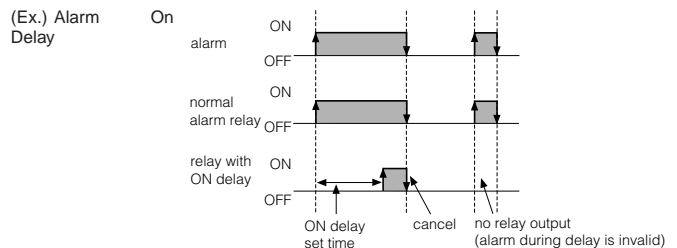

Use the following steps to set an alarm delay and hysteresis.

- 1 Display the alarm menu ("RL A Ch B").
- 2 Display hysteresis 1 ("R hB") and set the hysteresis.
- 3 Display delay time 1 ("dL Y") and set the delay.
- 4 Display delay time units 1 ("dL U") and set the units to minutes or seconds.
- 5 Set the values for alarm 2 to alarm 3 as necessary.
- 6 Press the **SEL** key to set the value.

4. Setting the operation menu

Sets the alarm value so that DO is used as the alarm output. Use the following steps to set this function.

- 1 Display the operation menu ("oPE Ch I").
- 2 Set the alarm 1 set value ("RL I") or "RL IL" and "RL h". The parameters displayed will vary according to the type of alarm.
- 3 Set up to alarm 3 as necessary.
- 4 Press the **SEL** key to set the value.

7-12 / Communication Functions

Set the following to communicate with the host.

Display	Parameter	Function
"5fno"	ST No. setting	Sets the station number.
"c0f"	Parity/baud rate setting	Choose the configuration of parity and baud rate
"5cc"	Setting communication permissions	Set whether or not the host has permission to overwrite.

Setting communication functions

- 1 Display the communication menu ("c0f Ch 9").
- 2 Display ST No. setting parameter ("5fno") and choose 1, and then display Parity/baud rate setting parameter ("c0f") and choose 9600 bps, even ("96E0"). This sets the baud rate to 9600 bps and the parity to "even".
- 3 Display communication permissions ("5cc") and choose to allow read and overwrite permissions ("r-b"). This sets the host to be allowed to read and overwrite the controller.
- 4 Press the key to set the value.
- 5 Turn the controller off and on again.

Caution The communication function settings will not be active until the power for the controller is turned OFF/ON.

7-13 / Re-transmission Output Function

The re-transmission output function delivers an analog output signal from the controller.

The following values can be output:

PV, SV, MV, DV (PV-SV)

Depending on the type of output, you can choose the voltage type or current type.

The re-transmission output also contains a scaling function.

The following example shows a re-transmission output of 100% when PV=960°C (80% FS) and a re-transmission output of 0% when PV=240°C (0% FS) for a PV range of 0 to 1200°C.

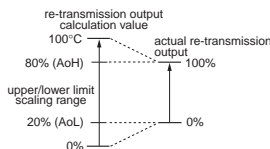

Setting re-transmission output function

- 1 Display the setup menu ("5ef Ch 6").
- 2 Display the AO output function parameter ("R0f") and choose the PV. This selects PV as the re-transmission output.
- 3 Display AO lower limit scaling ("R0L") and set the lower limit scaling (in this example, set it to 20%).
- 4 Display AO upper limit scaling ("R0H") and set the upper limit scaling (in this example, set it to 80%).
- 5 Press the key to set the value.

7-14 / Remote SV Function

The remote SV function controls the analog input signal coming into the controller as SV.

The input terminal becomes RSV1 or RSV2.

The remote SV function contains a zero/span adjustment function, as well as an input filter function.

The setup menu ("5ef Ch 6") must be set in the following manner before using the remote SV function.

Display	Parameter	Function
"rE0o" (REMO)	RSV Zero adjustment	Adjusts the zero of the RSV input
"rE0S" (REMS)	RSV Span adjustment	Adjusts the span of the RSV input
"rE0r" (REMr)	RSV input range	Sets the range for RSV input
"r-rF" (rTF)	RSV input filter	Sets the time constant for the RSV input filter

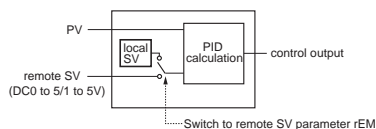

Switching to remote SV operation

- 1 Display the operation menu ("oPE Ch 1").
- 2 Display the switching to remote SV parameter ("r-EN") and choose remote ("r-EN").
- 3 Press the key to set the value.

Caution • Soft start is not displayed during the remote SV operation.
• Do not use remote SV and the SV selection function at the same time.

7-15 / Heater Break Alarm Functions

The heater wiring passes through the CT, allowing the current value to be monitored and detect errors in the heater line.

Heater break are detected by drops in the heater current. Setting the detection values activates this function.

- Related parameters: "hb", "hbH" ("RL Ch 8"), "cf", "Lc" ("fon Ch 5")

Refer to For details on the heater break alarm, refer to the "Operation Manual".

7-16 / Loop break Alarm

Detects when the control loop is open (break) without using the CT, but instead observing the control output and PV.

- Related parameters: "Lb", "LbH" ("RL Ch 8B")

Refer to For details on the loop break alarm, refer to the "Operation Manual".

7-17 / Load Short-circuit Alarm

The heater wiring passes through the CT, allowing the current value to be monitored and detect errors in the heater line.

The load short-circuit is detected by drops in the heater current. Setting the detection values activates this function.

- Related parameters: "hS", "hS H" ("RL Ch 8B")

Refer to For more details on the load short-circuit alarm, refer to the "Operation Manual".

7-18 / Other Functions

1. Soft start function

When turning on the equipment (including the temperature controller), the soft start function suppresses the MV to become maximum output. It places an upper limit on MV output for a specified amount of time after power is turned on.

This function is useful for effects such as suppressing the heater output during equipment start-up, and makes load lightened.

After the specified time has passed after switching on the equipment (or if SFTM = 0), the soft start function ends and normal controls begin.

Display	Parameter	Function
"5Fo" (SFO1)	MV1 soft start output set value	Places a limit on MV1 output after power is turned on for a time period set in SFTM.
"5FF" (SFTM)	Soft start set time	Sets the time for soft start to function after turning power on. Setting "0" will turn off soft start.

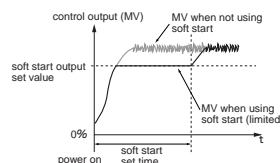

Caution The soft start function cannot be used simultaneously with the valve control functions, and cannot be used simultaneously with the dual control.

Point During manual mode, the manual output value has priority, but soft start will continue to keep track of the set time period.

Use the following steps to set soft start output set value and set time.

- 1 Display the setup menu ("5ef Ch 6").
- 2 Display soft start output 1 ("5Fo") and set the output value.
- 3 Display soft start set time ("5FF") and set the time.
- 4 Press the key to set the value.
- 5 Turn off the power once, and then re-start the controller to begin soft start. (When the soft start function is turned on, the lower display will alternate showing SoFT and SV.)
Note: Do not use auto-tuning at the same time.

2. Error output function

When the error output specification function has concluded that the equipment has an error, it halts the temperature controls and maintains the control output at a previously specified value. There is an error in PV if any of the following conditions occur:
burnout upper limit / burnout lower limit / underage (PV < -5% FS) / overage (105% < PV)



Use the following steps to set this function.

- 1 **Display the setup menu ("SEF Ch 5").**
- 2 **Display FALT output 1 set value ("FLo1") and set the output value.**
For dual control, set "FLo2" the same way.
- 3 **Press the  key to set the value.**

3. Standby output function

Sets the control output value, alarm output, re-transmission output (ON/OFF), and PV/SV display for standby mode.

Use the following steps to set this function.

- 1 **Display the setup menu ("SEF Ch 5").**
 - 2 **Display the standby mode setting ("Sbn") and set the alarm output, re-transmission output, and PV/SV display for standby mode.**
- Refer to  For the possible ON/OFF combinations for each output, see "6-6 Setup (Ch 6)" (page 8).
- 3 **Display the standby control output 1 set value ("Sbo1") and set the output value.**
For dual control, set "Sbo2" the same way.
 - 4 **Press the  key to set the value.**

4. Ramp SV function

The ramp SV function suppresses a sudden change in SV (step change) when changing SV. It allows SV to change smoothly according to the set slope of temperature per unit of time. This smooth SV change allows you to minimize the effect of the change on controls. You can set both inclining temperature and declining temperature slopes, and choose from "minutes" or "hours" for the time units. You can also choose for the SV display to show the current value or the target value during ramp SV.

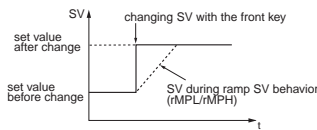

The SV lamp will blink while ramp SV is running. (When not displaying parameters or Ch.) When you turn on the power while ramp SV is in effect, ramp SV will begin using the starting value of PV (PV start).

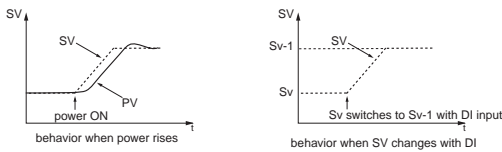

Use the following steps to set ramp SV.

- 1 **Display the system menu ("SYS Ch 7").**
- 2 **Set both ramp SV decline ("rNPL") and incline ("rNPH").**
- 3 **Set the unit of time for the slope ("rNPU") during ramp SV.**
- 4 **Press the  key to set the value.**

Point

- Ramp SV can be used with remote SV or SV selection functions.
- Ramp SV cannot be used at the same time with ramp soak.
- Coming out of a standby state will begin PV start.
- Make sure to check the controller's parameters after changing PV scale.

Caution

If the power is turned on during the input error, or released standby, the ramp SV operates differently from the normal PV start.

State at PV start	Operation
Standby	PV tracking (Maintains the state where SV=PV. The SV ramp function does not operate.)
Auto or manual	Starts the ramp SV from the current SV (PV start is off)

5. SV selection function

The SV selection function can record and switch up to eight sets of SV information to the palette menu settings. It is effective when the SV used during a process are numerous and the set values have been previously decided.

Use the following steps to save SV information.

- 1 **Display the palette menu ("PLF Ch 3").**
- 2 **Display SV setting 1 ("S01") and set SV1.**
- 3 **Set SV setting 2 through SV setting 7 in the same way as necessary.**
- 4 **Press the  key to set the value.**

The following four methods can switch SV.

- parameter "S0n" / press the user key / DI function / overwrite parameter "S0n" via the communication function

- Switch Using Parameter "S0n"

- 1 **Display the operation menu ("oPE Ch 1").**
- 2 **Display the selected SV number ("S0n") and choose the SV No.**
- 3 **Press the  key to set the value.**

- Switch Using the User Key

- 1 **Display the palette menu ("PLF Ch 3").**
- 2 **Display max selected SV number ("S0NH") and set the SV number by choosing it with the user key.**
- 3 **Display the user key function setting ("UKEY") and set it to SV selection function.**
- 4 **On the PV/SV display, pressing the user key will switch you from the currently selected SV to the next SV.**

- Switch Using DI Function

- 1 **Display the operation menu ("oPE Ch 1").**
- 2 **Display the selected SV number ("S0n") and choose "di".**
- 3 **Display the di function setting ("dC1" to "dC3") and set the SV selection function.**

- Switch Using Parameter "S0n" via the Communication Function

- 1 **In the communication, overwrite the set value to the selected SV number ("S0n").**

6. PID selection function

Point

When switching the normal and reverse operation by using the PID selection function, be sure to turn off the system power beforehand for safety reasons (Do not switch normal and reverse operation during control).

The SV selection function can record and switch up to eight sets of PID parameters from the palette menu settings.

It is effective when the control equipment changes the target often and must frequently change the PID parameters.

Use the following steps to save PID information.

- 1 **Display the palette menu ("PLF Ch 3").**
- 2 **Display proportional bandwidth setting 1 ("P1") and set P1.**
- 3 **Set "i1" and "d1" in the same way.**
Set the following parameters as necessary: ON/OFF control hysteresis ("hYS"), cooling proportional band ("CoL"), dead band ("db"), balance ("bAL"), anti-reset windup ("AR"), and normal/reverse setting ("REV").
- 4 **Press the  key to set the value.**

The PID parameter selection (P, i, d, normal and reverse settings) can be changed by the same four methods as the SV selection function.

- Switch Using Parameter "PLn1"

- 1 **Display the operation menu ("oPE Ch 1").**
- 2 **Display the selected PID number ("PLn1") and choose the PID No.**
- 3 **Press the  key to set the value.**

- Switch Using the User Key

- 1 Display the palette menu ("PLF Ch 3").
- 2 Display max selected PID number ("PL #n") and set the PID number by choosing it with the user key.
- 3 Display the user key function setting ("UEY") and set it to PID selection function.
- 4 On the PV/SV display, pressing the user key will switch you from the currently selected PID to the next PID.

Point When the user key function code is 27 (SV No.+1, PID No.+1 (send)) and the initial PID No. and SV No. are different, the first time you press the user key, PID No. will become the same as SV No. Also the SVMX parameter value becomes the maximum selectable number for PID No. and SV No.

- Switch Using DI Function

- 1 Display the operation menu ("ope Ch 1").
- 2 Display the selected PID number ("S_n") and choose "di".
- 3 Display the di function setting ("di 1" to "di 3") and set the PID selection function.

- Switch Using Parameter "PLn 1" via the Communication Channel

- 1 In the communication, overwrite the set value for the selected PID number ("PLn 1").

7. Startup mode function

The startup mode specification function sets the controller to start up in either auto mode, manual mode, remote mode or standby mode. It is used when you want to start up in manual mode.

Use the following steps to set this function.

- 1 Display the system menu ("SYS Ch 7").
- 2 Display the startup mode ("S_{fn}") and choose the operational mode. Choose from auto or manual.
- 3 Press the key to set the value. After changing the above setting, restarting the controller will start it in the selected mode.

Point When starting up in manual, the MV becomes 0%.

8. User function key

Pressing the key in the monitor screen display, channel screen display, or parameter screen display will immediately return you to the PV/SV display, regardless of assigned function. Holding the key down for about a second in PV/SV display or PV/MV display (only during manual mode) will run the assigned function. The standard factory default for the key is switchover between auto and manual modes.

Refer to For functions that can be assigned, see "6-7 System (Ch7)" (page 8).

Use the following steps to set this function.

- 1 Display the system menu ("SYS Ch 7").
- 2 Display the assign user key specification ("UEY") and choose the function.
- 3 Press the key to set the value.

9. bAL and Ar functions

- The anti-reset windup function ("AR") cuts integration that falls outside of the Ar set range that is centered around SV. Running auto-tuning will set the optimum values for P, i, and d parameters, as well as Ar.

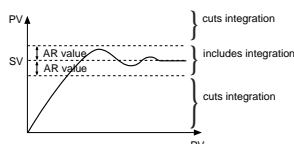

- The output convergence value function ("bAL") outputs to PV and SV a calculated result of the PID computed MV plus the bAL offset. (The factory setting of bAL is 0% for single output, 50% for dual output.)

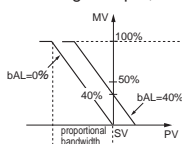

Point Ar1 to Ar7 and bAL1 to bAL7 have the same function as in each PID group.

10. MV limit function

The MV limit function allows you to choose whether to limit the MV or let it pass through maximum and minimum MV.

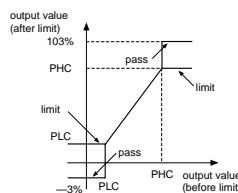

PCUT	MV1		MV2	
	PHC1	PLC1	PHC2	PLC2
"0"	103%	-3%	103%	-3%
"1"	103%	limit	103%	-3%
"2"	limit	-3%	103%	-3%
"3"	limit	limit	103%	-3%
"4"	103%	-3%	103%	limit
"5"	103%	limit	103%	limit
"6"	limit	-3%	103%	limit
"7"	limit	limit	103%	limit
"8"	103%	-3%	limit	-3%
"9"	103%	limit	limit	-3%
"10"	limit	-3%	limit	-3%
"11"	limit	limit	limit	-3%
"12"	103%	-3%	limit	limit
"13"	103%	limit	limit	limit
"14"	limit	-3%	limit	limit
"15"	limit	limit	limit	limit

8 Setting the Temperature Controller

8-1 / Input Setting

Set the type and the range for input sensor. Input can be set in the setup menu ("SEf Ch 5"). For more on input types, input scaling, decimal point location, and input codes, see "10 Input Range and Codes (standard range)". (page 18)

1. Choose an input type ("P_{DF}")
Check the type of the thermocouple or resistance bulb which is used.
2. Set the PV scaling (input range) ("P_{Db}" / "P_{DF}")
Set Pvb to the lower limit of the temperature range and Pvf to the upper limit. It is recommended to set the values at the standard range, even though they can be set at values beyond of it. There is no standard range for DC voltage or DC current input. (-1999 to 9999, lower limit-upper limit)
3. Set the decimal point location ("P_{Dd}")
Sets whether or not to display digits after the decimal point. Two digits can also be displayed after the decimal point when using 1 to 5V DC, and 4 to 20mA DC.

Point PV scaling and decimal point location can be used with the factory settings.

8-2 / Output Setting

Sets the control output. (Only when the output is current or voltage.)

1. Sets the range of the control output (OUT1/OUT2) ("E_{lr}" / "E_{lr}")
Choose any of 0 to 5V, 1 to 5V, 0 to 10V, 2 to 10V, 0 to 20mA or 4 to 20mA DC.

8-3 / Control Setting

- Sets controls to normal operation or reverse operation.
- Reverse operation: As the process value (PV) rises, the control output (MV) becomes smaller. Used to heat the control object.
- Normal operation: As the process value (PV) rises, the control output (MV) becomes larger. Used to cool the control object.

1. Set the normal or reverse operation ("r_{ED}")
Choose any of the following combinations of heat and cool to suit your system.

rEv	Control output 1	Control output 2
rv--	Reverse	-
no--	Normal	-
rvno	Reverse	Normal
norv	Normal	Reverse
rvrv	Reverse	Reverse
nono	Normal	Normal

9 Error Indications

9-1 / Display During Equipment Error

This controller has a display function to indicate several types of error code shown below. If any of the error code is displayed, please eliminate the cause of error immediately. After the cause is eliminated, turn off the power once, and then re-start the controller.

Display	Possible cause	Control output
"UUUU"	① Thermocouple burnout. ② Resistance bulb sensor (A) burnout. ③ PV exceeds upper limit of the range by 5%FS.	Output as setting value when an error occurs (set in parameter Flo1 or Flo2)
"LLLL"	① Resistance bulb sensor B or C wire burnout. ② Resistance bulb sensor (between A & B or A & C) short. ③ PV is below lower limit of the range by 5%FS. ④ Burnout or short in the voltage input.	
"LLLL"	① PV < -199.9	
"Errr" (SV flickers)	Incorrect setting (Pvb/PvF)	
PV is not displayed	① H'4000 is added into the dP30 set value ② SbMd set value is set at 4 to 7, and STbY is ON	Normal control * The controller does not have to be restarted
SV is not displayed	① H'2000 is added into the dP30 set value ② SbMd set value is set at 4 to 7, and STbY is ON	Normal control * The controller does not have to be restarted
Parameters may not be displayed	① Check the settings of dP01 to dP30 ② Check the password function	Normal control * The controller does not have to be restarted

Note) The error display does not appear even when it must appear depending on the setting of parameter SbMd ("SEr CH6").

10 Input Range and Codes (standard range)

Input type	Measurement range [°C]	Measurement range [°F]	Smallest input increment °C	Input code	
Resistance bulb JIS (IEC)	Pt 100Ω	0 to 150	32 to 302	0.1	"j"
		0 to 300	32 to 572	0.1	
		0 to 500	32 to 932	0.1	
		0 to 600	32 to 1112	1	
		-50 to 100	-58 to 212	0.1	
		-100 to 200	-148 to 392	0.1	
Thermocouple	J	0 to 400	32 to 752	0.1	"2"
		0 to 1000	32 to 1832	1	
	K	0 to 400	32 to 752	0.1	"3"
		0 to 800	32 to 1472	0.1	
		0 to 1200	32 to 2192	1	
	R	0 to 1600	32 to 2912	1	"4"
	B	0 to 1800	32 to 3272	1	"5"
	S	0 to 1600	32 to 2912	1	"6"
	T	-200 to 200	-328 to 392	0.1	"7"
		-200 to 400	-328 to 752	0.1	
	E	0 to 800	32 to 1472	0.1	"8"
		-200 to 800	-328 to 1472	1	
	N	0 to 1300	32 to 2372	1	"12"
		PL-2	0 to 1300	32 to 2372	
DC voltage	0 to 5V DC	-1999 to 9999 (Range where scaling is allowed)		"15"	
	1 to 5V DC			"16"	
	0 to 10V DC			"17"	
	2 to 10V DC			"18"	
DC current	0 to 100mV DC			"19"	
	0 to 20mA DC			"15"	
	4 to 20mA DC			"16"	

Note 1 : For DC current input, attach a 250Ω resistance to convert the range to 1 to 5V or 0 to 5V DC.

Note 2 : Input accuracy is ±0.3% FS ± 1 digit ± 1°C or 2°C whichever greater.

Except, B thermocouple 0 to 400°C: ±5% FS ± 1 digit ± 1°C

R thermocouple 0 to 500°C: ±1% FS ± 1 digit ± 1°C

T thermocouple -200 to -150°C: ±0.5% FS ± 1 digit ± 1°C

Note 3 : Input accuracy cannot be ensured when using an input smaller than the minimum range.

11 Alarm Action Type Codes

Type	DO1 to DO3	Alarm Type	Action diagram	
	0	No alarm	-	
Absolute value alarm	1	High alarm		
	2	Low alarm		
	3	High alarm (with hold)		
	4	Low alarm (with hold)		
Deviation alarm	5	High alarm		
	6	Low alarm		
	7	High/Low alarm		
	8	High alarm (with hold)		
	9	Low alarm (with hold)		
	10	High/Low alarm (with hold)		
	Zone alarm	11	High/Low deviation alarm	
		12	High/Low absolute alarm	
		13	High/Low deviation alarm	
		14	High absolute/Low deviation alarm	
15		High deviation/Low absolute alarm		

● Dual Set Value Alarm Codes

Type	DO1 to DO3	Alarm Type	Action diagram
High/Low limit alarm	16	High/Low absolute alarm	
	17	High/Low deviation alarm	
	18	High absolute/Low deviation alarm	
	19	High deviation/Low absolute alarm	
	20	High/Low absolute alarm (with hold)	
	21	High/Low deviation alarm (with hold)	
	22	High absolute/Low deviation alarm (with hold)	
	23	High deviation/Low absolute alarm (with hold)	

12 Model Specifications

12-1 / PXG4 Standard Model List

Type	DO1 to DO3	Alarm Type	Action diagram
Zone alarm	24	High/Low absolute alarm	
	25	High/Low deviation alarm	
	26	High absolute/Low deviation alarm	
	27	High deviation/Low absolute alarm	
	28	High/Low absolute alarm (with hold)	
	29	High/Low deviation alarm (with hold)	
	30	High absolute/Low deviation alarm (with hold)	
	31	High deviation/Low absolute alarm (with hold)	

● Timer Code

Type	DO1 to DO3	Alarm Type	Action diagram
Timer	32	ON delay timer	
	33	OFF delay timer	
	34	ON/OFF delay timer	

Point

What is alarm with hold?
The alarm will not turn ON immediately when the process value gets into the alarm band and enters again. If without hold, alarm may turn ON when starting up.

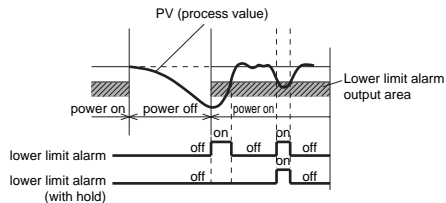

Caution

- When alarm action code is changed, alarm set value may also become different from previous settings.
- When alarm action type code is changed, turn off the power once, and then re-start the controller, before starting control.
- ALn: AL1 to AL3 show the alarm set values
- ALnh: AL1h to AL3h show the alarm set values
- ALnL: AL1L to AL3L show the alarm set values
- dLYn: dLY1 to dLY3 show the alarm delay on set values

(Note1) Available only for DO2

* Other than the alarm setting, each of the event output functions can be assigned to DO1 to 3.

For more details on each of the event output functions, refer to "7-12. Digital output" - "1. DO event setting" (page 14).

Digit	Specifications	1	2	3	4	5	6	7	8	9	10	11	12	13	14	Notes
4	<Size of front WxH> 48 x 48 mm	P	X	G	4											
5	<Output 1> Relay contacts SSR drive Current (0 to 20mA DC / 4 to 20mA DC) Voltage (0 to 5V DC / 1 to 5V DC / 0 to 10V DC / 2 to 10V DC)						A C E P									Note 1 Note 1
6	<Output 2> None Relay contacts SSR drive Current (0 to 20mA DC / 4 to 20mA DC) Voltage (0 to 5V DC / 1 to 5V DC / 0 to 10V DC) Re-transmission output current (0 to 20mA DC / 4 to 20mA DC) Re-transmission output voltage (0 to 5V DC / 1 to 5V DC / 0 to 10V DC / 2 to 10V DC)						Y A C E P R S									Note 2,4 Note 2,4 Note 2,4 Note 2,4 Note 2,4 Note 2,4
7	<Option 1> None RS485 Digital input (No. 1) + digital input (No. 2) Digital input (No. 1) + RSV1 Digital input (No. 1) + CT1 RS 485 + digital input (No. 1) RS 485 + RSV1 RS 485 + CT1 RS 485 + Digital input (No. 1) + RSV1 Digital input (No. 1) + RSV1 + Digital input (No. 2)						Y M T H G V K J F 2									Note 1,3 Note 1,3 Note 4 Note 4
8	<Revision symbols>							1								
9	<Digital Output> (Relay contact output) None Digital output 1 point (No.1) Digital output 2 points (No.1, 2) Digital output 3 points (No.1, 2, 3) Digital output 2 points [independent common] (No.1, 2)								0 1 F M J							Note3 Note2
10	<Power supply> < Instruction manual> 100V/240V AC no instruction manual 100V/240V AC English instruction manual 24V AC/DC no instruction manual 24V AC/DC English instruction manual									N V C B						
11	<Option 2> None										Y					
12												0				
13													0			

Note 1: If output 1 was for current or voltage output, option cannot be assigned to CT1. (If 7th digit was assigned to G or J, 5th digit cannot be assigned to E nor P.)

Note 2: If output 2 was for relay contact, SSR drive, current, voltage or retransmission output, 3 digital outputs cannot be assigned. (If 6th digit was assigned to A, C, E, P, R or S, 9th digit cannot be assigned to M.)

Note 3: If CT1 was selected in option 1, none in <Digital output> cannot be assigned. (If 7th digit was assigned to G or J, 9th digit cannot be assigned to 0.)

Note 4: If RSV1 in option 1 and digital input 1 were selected simultaneously, output 2 cannot be assigned. (If 7th digit was assigned to F or 2, 6th digit cannot be assigned to A, C, E, P, R nor S.)

12-2 / PXG4 Motorized Valve Control Model List

Digit	Specifications	1	2	3	4	5	6	7	8	-	9	10	11	12	13	-	14	Notes
4	<Outer dimensions WxH> 48 x 48 mm	P	X	G	4													
5	<Output 1> Electromagnetic valve control output					S												Note 1
6	<Output 2> None						Y											
7	<Option 1> None Digital input (No. 1) + RSV1 Digital input (No. 1, 2, 3) RS 485 + digital input (No. 1) RS 485 + RSV1							Y										
8	<Revision symbols>								1									
9	<Digital Output> (Relay contact output) None Digital output 1 point (No.1) Digital output 2 points (No.1, 2) Digital output 2 points [independent common] (No.1, 2)										0							
10	<Power supply> < Instruction manual> 100V/240V AC no instruction manual 100V/240V AC English instruction manual 24V AC/DC no instruction manual 24V AC/DC English instruction manual											N						
11	<Option 2> None												Y					
12														0				
13															0			

Note 1: If front panel size 48 x 48, position feedback input (PFB input) function is not available.

13 Specifications

Power Supply	100 (-15%) to 240V AC (+10%), 50/60Hz, 24V DC/AC (±10%)
Power Consumption	12VA or less
Control Output	Relay contact output • 1a contact 220V AC / 30V DC , 3A (resistance load) SSR/SSC drive output (voltage pulse output) • ON 20V DC (18 to 24V DC) • OFF 0.5V DC or less • Max Current 20mA DC or less (both OUT1 and OUT2) • Load resistance 850Ω or more Current Output • 0 to 20mA DC / 4 to 20mA DC • Acceptable load resistance 600Ω or less • Accuracy: ±5%FS Voltage output • 0 to 5V DC / 1 to 5V DC / 0 to 10V DC / 2 to 10V DC • Resistance load 10kΩ or more • Accuracy: ±5%FS
Process value input	Input accuracy • Thermocouple input: greatest one among ±0.3%FS, ±1 digit, and ±1°C or 2°C • Resistance bulb input: greatest one among ±0.3%FS, ±1 digit, and ±0.5°C • mV input, voltage input, current input : ±0.3%FS±1digit Indication resolution: ±0.3%FS or less
Digital Output	Relay contact output (DO1 to DO3) • 1a contact 220V AC / 30V DC , 3A (resistance load)
Digital input	Contact or Transistor type Max 3 inputs 30V DC, 3mA (1 input) • Judged ON 1kΩ or less (contact), or 5V DC or less (transistor) • Judged OFF 100kΩ or more (contact), or 18V DC or more (transistor)
Re-transmission output	0 to 20mA DC / 4 to 20mA DC / 0 to 5V DC / 1 to 5V DC / 0 to 10V DC / 2 to 10V DC Re-transmission data: PV, SV, DV, MV Accuracy: ±0.2%FS Resistance load : 600Ω or less (Current), 10kΩ or more (voltage)
Remote SV Input	1 to 5V DC / 0 to 5V DC, 0 to 20mA DC / 4 to 20mA DC (use an external 250Ω resistor)
Heater break detector (CT) input	Single-phase type CT 1 input, 1 to 30A / 20 to 50A
Motorized valve control output	1a (SPST) contact x 2, 220V AC / 30V DC , 1A
Communication Functions	RS-485 interface Communication method: Half-duplex bit serial asynchronous cycle Communication rate: 9600bps, 19200 bps Protocol: Modbus RTU compatible Communication distance: Max 500m (total connection length) Connectable units: 31 units
Loader Interface	RS-232C interface Connection method: ø2.5 mini-plug/jack (use the included cable at the bottom of the case) Communication method: Full-duplex bit serial asynchronous cycle Communication speed: 9600bps parity/none Protocol: Modbus RTU compatible
Operation and storage conditions	Range of usable temperatures: -10 to 50°C, ambient humidity 90% RH or less (non condensing) -20 to 60 °C (storage temperature)