

Operating Instruction
for
Electronic Flow Monitor
Compact Version

Model: KAL-K



1. Contents

1. Contents.....	2
2. Note	3
3. Instrument Inspection.....	3
4. Regulation Use.....	3
5. Operating Principle.....	4
6. Mechanical Connection.....	5
7. Electrical Connection and Operational Elements	5
8. Characteristics	7
9. Output Characteristic (only for 24 V _{DC})	8
10. Commissioning.....	9
11. Maintenance	10
12. Technical Information.....	11
13. KAL-K Diagnostics	12
14. Order Codes	12
15. Spare parts	12
16. Dimensions	13
17. EU Declaration of Conformance.....	15

Manufactured and sold by:

Kobold Messring GmbH
Nordring 22-24
D-65719 Hofheim
Tel.: +49(0)6192-2990
Fax: +49(0)6192-23398
E-Mail: info.de@kobold.com
Internet: www.kobold.com

2. Note

Please read these operating instructions before unpacking and putting the unit into operation. Follow the instructions precisely as described herein.

The devices are only to be used, maintained and serviced by persons familiar with these operating instructions and in accordance with local regulations applying to Health & Safety and prevention of accidents.

When used in machines, the measuring unit should be used only when the machines fulfil the EC-machine guidelines.

3. Instrument Inspection

Instruments are inspected before shipping and sent out in perfect condition.

Should damage to a device be visible, we recommend a thorough inspection of the delivery packaging. In case of damage, please inform your parcel service / forwarding agent immediately, since they are responsible for damages during transit.

Scope of delivery:

The standard delivery includes:

- Electronic Flow Monitor, Compact Version model: KAL-K
- Operating Instructions

4. Regulation Use

The KOBOLD KAL-K Flow Monitor is intended for use in monitoring and control applications involving moderate flow rates of low-viscous or dirty liquids.

Limiting Signal

The devices are equipped with NPN or PNP signals (24 V_{DC}- power supply) or relay (110 V_{DC}, 110 V_{AC}, 230 V_{AC} power supply) for monitoring the flow velocity of liquids.

Trend Display

A LED bar graph display indicates the current flow rate and the set point via a flashing LED.

6. Mechanical Connection

Prior to installation

- Ensure that the actual system flow rate is within the switching range of the KAL-K.
- Ensure that the maximum system temperature and pressure are within the limits specified per section. (see section 12. Technical Information)

Fitting

Mount the sensor into the piping and make sure that it is completely filled with fluid. The probe tip has to reach at least 5 mm (better > 5 mm) into the pipe (see below).

Fitting position

The sensor can be mounted in any orientation as long as the piping is completely filled with fluid. The mounting position has to be smooth and free of turbulence.

(Recommended input and output length: 5 x pipe diameter, of straight - run piping both upstream and downstream of the flow switch). In case of sediments in the pipe the shown mounting position is recommended.

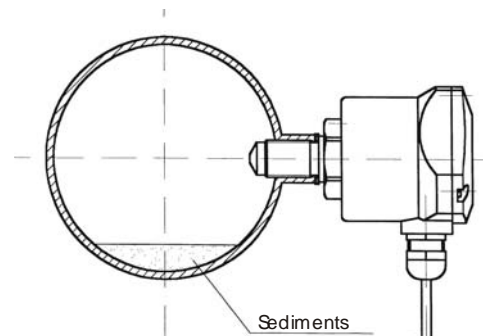

7. Electrical Connection and Operational Elements



Attention ! Ensure that the power is disconnected during the connection of the cable.

Ensure that the voltage of your installation corresponds to the voltage values given on the device's specification plate.

24 V_{DC}-Version (terminal connector)

- Remove electronic cover (The fixing screws are secured against falling out)
- Strip 3-wire cable (approx. 40-60 mm), strip single wires (approx. 4-6 mm) and pull through cable gland.

1		Output
2		Ground
3		+24 V _{DC}

- Connect wires to terminal connector block according to the drawing.
- Tighten cable gland.
- After connection, apply supply voltage of 24 VDC \pm 20%. (see 12. Technical Information)
- Check function of electronic (set point LED must flash)
- Calibrate flow switch (see 10. Commissioning)

24 V_{DC}-Version (plug or plug with cable)

- Connect wires to terminal connector block according to drawing below.
- After connection apply supply voltage of 24 VDC \pm 10 %. (see 12. Technical Information)
- Check function of electronic (set point LED must flash)
- Calibrate flow switch (see 10. Commissioning)

View upon the plug

- | | | |
|---|-------|----------|
| 1 | brown | + 24 VDC |
| 2 | white | output |
| 3 | blue | 0 VDC |
| 4 | black | output |

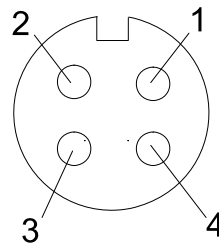

110 V_{DC}, 110 V_{AC} or 230 V_{AC}-version

- Remove electronic cover.
(The fixing screws are secured against falling out)
- The devices are supplied either with coded cables or a plug connection.
- Connect single wires or plug according to drawings below.
- After connection apply supply voltage according to label on the device and technical data (for tolerances see section 12. Technical Information).
- Check function of electronic (set point LED must flash).
- Calibrate Flow Monitor (see 10. Commissioning).

cable

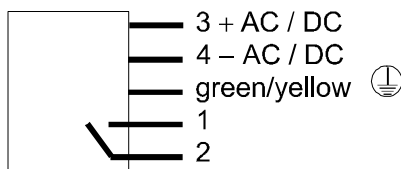

plug

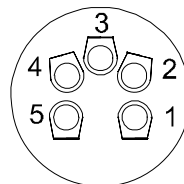

- | | |
|----|-----------|
| 2: | - DC / AC |
| 4: | + DC / AC |
| 3: | PE: |
| 1: | |
| 5: | |

8. Characteristics

LED Trend Indicator (1)

The LED trend indicator (8 LEDs) is used to indicate

- the flow rate (LED, starting left). The adjusted switching point is indicated by a flashing LED.
- If the flow rate has reached the set point value selected by the user, then the LED is flashing faster.

Bi-coloured LED (2)

The bi-coloured LED serves

- to display the switching point.
 RED = ALARM (flow below the set point)
 GREEN = (flow above the set point)

The bi-coloured LED is lit all time during this operation mode.

- If a calibration is done the bi-coloured LED flashes green (see also section 10. Commissioning.).
- If any signal error occurs the bi-coloured LED flashes red.

SET pushbutton (3)

The calibration switch (set) is used to start the flow calibration procedure.

Set point Potentiometer (4)

The set point potentiometer is used to adjust the flow set point. You will notice that the flashing LED moves along the trend indicator scale as the set point potentiometer is adjusted.

Output Selector Switch (only for 24 V_{DC}) (5)

The output selector switch is used to select between the output logic NPN and PNP.

(Output selector switch right: NPN-output
 Output selector switch left: PNP-output)

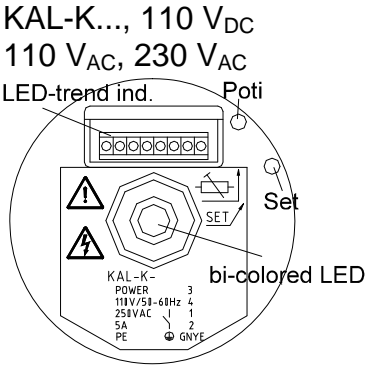
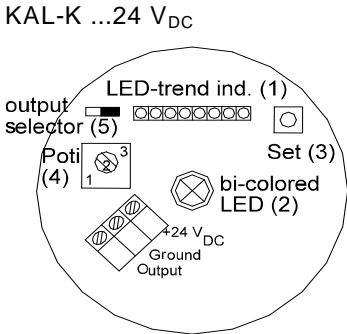

9. Output Characteristic (only for 24 V_{DC})

The output characteristics can be set by the output selector switch.

NPN output:

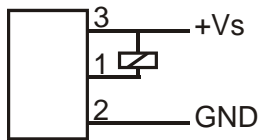

The semiconductor output switches to GND (GROUND = 0 V_{DC}) or is highly resistant. The maximum output current is 400 mA.

The reference point for the NPN-output is +24 V_{DC}.

PNP-output

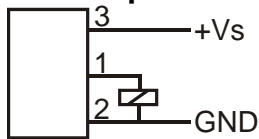

The semiconductor output switches to +24 V_{DC} or is highly resistant. The maximum output current is 400 mA. The reference point for the PNP-output is GND (GROUND = 0 V_{DC}).

Output function

N/O function

In the N/O function the output switches into the low resistance state.

	PNP	NPN	DUO-LED
Actual value > set point			green
Actual value < set point			red
Break down power supply			off

It is recommended to operate with the N/O switch output because in case of system flow being above the flow set point - which means that the N/C switch is de-activated - and the power supply breaks down the output switch will not be able to switch an "ALARM" anymore.

N/C Switch

(Not recommendable for safety reasons)

	PNP	NPN	DUO-LED
Actual value > set point			green
Actual value < set point			red
Break down power supply			off

10. Commissioning

The use of this meter in machines according to directive 89/392/EWG is prohibited until the complete machine complies to this directive.

After mechanical ("Mechanical Connection") and electrical ("Electrical Connection") installation of the sensor the KAL-K has to be put into operation as described in this section.

Calibration

a) Zero flow calibration

- Stop the flow of the liquid in the piping in which the sensor is installed. It is important that the sensor tip be immersed in the liquid. There should be no bubbles around the sensor tip.
- Turn set point adjustment potentiometer counter clockwise to its far left-hand stop and now briefly press the SET button.
- The bi-coloured LED will flash green.
- Do not make any changes (potentiometer setting, etc.) while the bi-coloured LED is blinking. This adjustment phase will last approx. 5-15 sec.
- When the bi-coloured LED stops flashing, the zero flow calibration is set.
- The device now switches automatically to the monitoring mode and displays no flow. The LED strip is not illuminated; only the threshold value LED is flashing.
- The Flow Monitor is ready for operation.

b) Calibration of the trend indicator span

The KAL-K is factory checked and pre-set at its maximum span.

At a lower flow speed, not all 8 LEDs will illuminate. To achieve finer monitoring resolution, the measuring range can be adapted to better fit the actual flow speed.

- Rotate the potentiometer clockwise as far as it will go to the right-hand stop. The extreme right-hand LED in the LED strip will blink. Set the desired maximum flow speed.
- Now press the SET button. The bi-coloured LED blinks green.
- Do not make any changes (potentiometer setting, etc.) while the bi-coloured LED is blinking. This adjustment phase will last approx. 5-15 sec.
- The device now switches automatically to the monitoring mode. This adjustment has set the device measuring range so that it now extends across the entire LED strip to indicate the flow value.
- The adjustment procedure is now complete. It may be repeated as often as necessary.

c) Measuring mode

After adjustment, the flow monitor is once again in measuring mode.

The flow is constantly monitored and the actual value of the flow speed is displayed on the LED strip.

Switching point adjustment

The potentiometer is now used to set the switching point (threshold) of the flow switch. The switching point is displayed as a blinking LED. If the flow rate increases to the point that illuminated LEDs (actual flow value) reaches the position of the blinking LED (set point), the flow monitor switches over from ALARM to FLOW. This can be seen at the display: the bi-coloured LED that was showing a steady red light now switches to a steady green light. The output is also switched at the same time.

slowly flashing switching point-LED (set point)

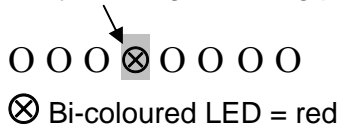

Actual value < set point

Alarm status

Actual value = 0: no flow present

slowly flashing switching point-LED (set point)

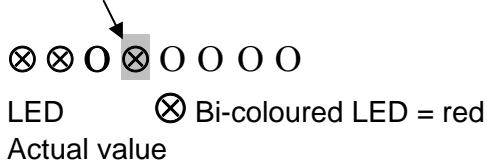

Actual value < set point

Alarm status

Actual value too low

fast flashing switching point-LED (set point)

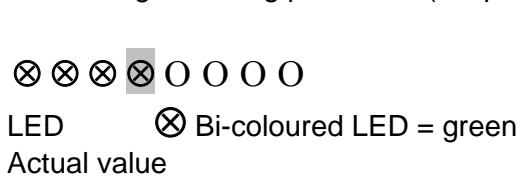

Actual value = set point

Flow status currently being switched

Actual value has just reached set point

slowly flashing switching point-LED

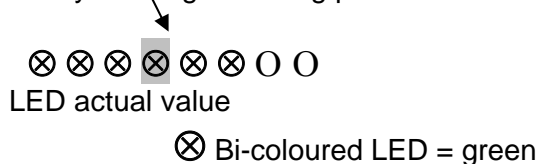

Actual value > set point

Flow status (ideal conditions)

This is the most desirable status.

After the settings are completed, screw the cover tightly back on the housing

11. Maintenance

The unit is virtually maintenance free. Occasional cleaning of the immersed probe may be required if the fluid media is such that it tends to deposit or build.

12. Technical Information

Electronic

Power supply:	24 V _{DC} ±10% 110 V _{DC} ± 30 %, 110, 230 V _{AC} – 20/+10 %,
Power input:	max. 4,5 (typically 1,2 W) max. 3,6 W for 24 V _{DC}
Ambient temperature:	-20 °C ... +60 °C
CIP compatibility:	max. 140 °C non-operating
Max. pressure:	100 bar
Time delay before availability:	max. 12 s
Switching range: approx.	4 cm/s to 200 cm/s
Temperature gradient:	unlimited
Response time:	typically 5,6...12 s upon request: 2 - 5,6 s (KAL-KS...)
Flow rate indication:	trend indication with 8-LED's
Switch point adjustment:	with potentiometer, optical indication on LED chain with flashing LED
Output indicator:	LED, red = alarm, green = flow OK
Switching output:	24 V _{DC} version: semiconductor PNP/NPN switchable, max. 400 mA, short-circuit proof 110 V _{DC} version: relay max. 0,2 A /110 V _{DC} 110 V _{AC} , 230 V _{AC} version: relay max. 5 A
N/O function:	actual value ≥ set point value;(standard setting: green LED is energised) output switched through
N/C function:	available as option
Protection type:	IP 65
Case material:	polyamide

Sensor

Medium Temperature:	-20 to +80 °C (standard) 0 to +120 °C (high temperature version)
Maximum Pressure:	100 bar
Connection:	G 1/2 (G 1/4, G 3/4, M 12x1, 1/4" NPT, 1/2" NPT, 3/4" NPT)
Wetted Parts:	1.4305 (KAL-K1215) 1.4301 (all units with order code KAL-K*3) 1.4571 (all units with order code KAL-K*4)

13. KAL-K Diagnostics

The KAL-K continuously self monitors the sensing probe and the micro-processor system upon short-circuit and circuit breaker. Any fault in these portions of the electronics will be signalled by a flashing red bi-coloured LED (⇒ KOBOLD Service).

14. Order Codes

Order example: **KAL-K1215 S PG 3**

Version	Connection	Material stainless steel / version					Type of contact	Electrical connection	Power supply
		1.4301		1.4305	1.4571				
		Standard version	Extended version	Standard version	Standard version	Extended version			
Standard version (-20...+80 °C)	G 1/4	KAL-K1308	-	-	KAL-K1408*	-	S=N/O contact Ö=N/C contact	PG=cable gland M16x1,5 ST=connector** M12x1 SK=circular connector with socket	0=230 V _{AC} 1=110 V _{AC} 3= 24 V _{DC} 6=110 V _{DC}
	G 1/2	KAL-K1315	KAL-K6315	KAL-K1215	KAL-K1415	KAL-K6415			
	G 3/4	KAL-K1320	KAL-K6320	-	KAL-K1420*	KAL-K6420*			
	M 12x1	KAL-K0312	-	-	-	-			
	1/4 NPT	KAL-K5308	KAL-K8308	-	KAL-K5408*	KAL-K8408*			
	1/2 NPT	KAL-K5315	KAL-K8315	-	KAL-K5415	KAL-K8415			
	3/4 NPT	KAL-K5320	KAL-K8320	-	KAL-K5420*	KAL-K8420*			
	Tri-Clamp, DIN 32676	-	-	-	KAL-K4440***	-			
Version for high temperature (0... +120 °C)	G 1/4	KAL-KH1308	KAL-KH6308	-	KAL-KH1408*	KAL-KH6408*	S=N/O contact Ö=N/C contact	PG=cable gland M16x1,5 ST=connector** M12x1 SK=circular connector with socket	0=230 V _{AC} 1=110 V _{AC} 3= 24 V _{DC} 6=110 V _{DC}
	G 1/2	KAL-KH1315	KAL-KH6315	KAL-KH1215	KAL-KH1415	KAL-KH6415			
	G 3/4	KAL-KH1320	KAL-KH6320	-	KAL-KH1420*	KAL-KH6420*			
	M 12 x 1	KAL-KH0312	-	-	-	-			
	1/4 NPT	KAL-KH5308	KAL-KH8308	-	KAL-KH5408*	KAL-KH8408*			
	1/2 NPT	KAL-KH5315	KAL-KH8315	-	KAL-KH5415	KAL-KH8415			
	3/4 NPT	KAL-KH5320	KAL-KH8320	-	KAL-KH5420*	KAL-KH8420*			
	Tri-Clamp, DIN 32676	-	-	-	KAL-KH4440***	-			

Please specify sensor length dimension C for extended version.

*Stainless steel hexagon 1.4301

**for 24 V_{DC}

***Stainless steel 1.4404

15. Spare parts

No spare parts are required.

16. Dimensions

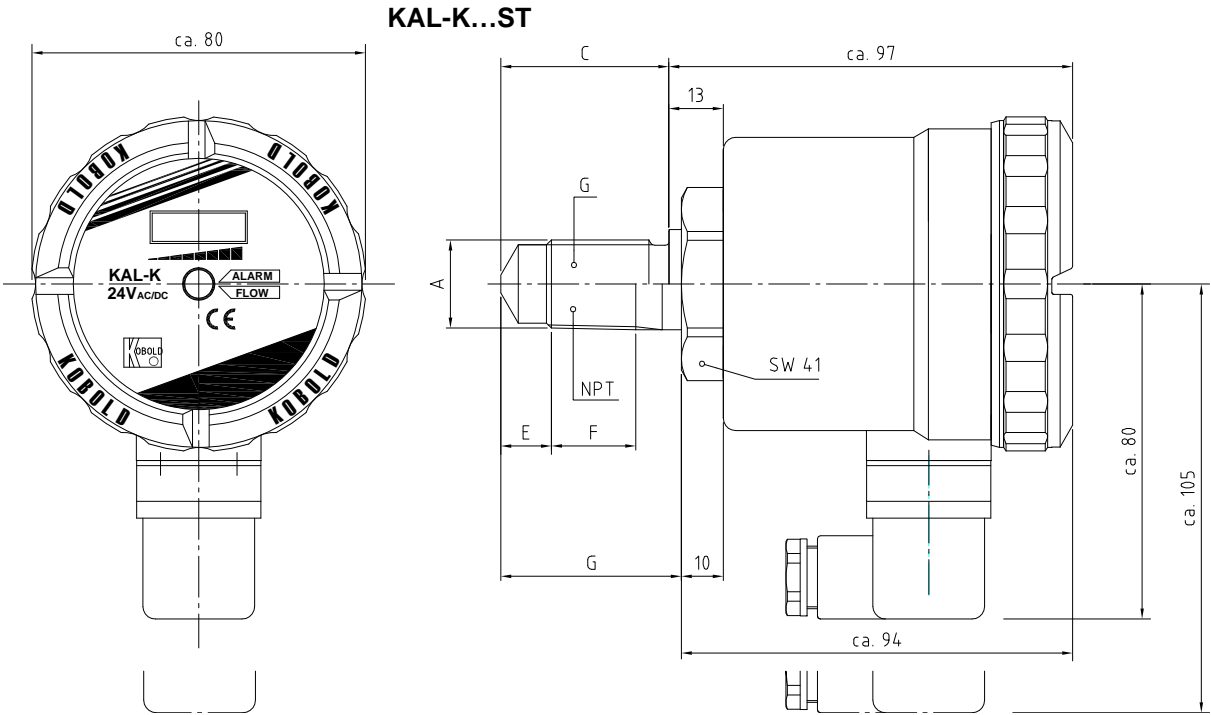

A	1.4301	1.4305	1.4571
G 1/2	X	X	X
1/2 NPT	X	---	X
G 1/4	X	---	X
G 3/4	X	---	---
M 12x1	X	---	X
1/4 NPT	X	---	X
3/4 NPT	X	---	X

KAL-K., KAL-A(K)...

A	C [mm]	E [mm]	F [mm]	G [mm]
G ¼	26	7	-	-
G ½	40	9	-	-
G ¾	43	12	-	-
M12 x 1	23	6	-	-
¼" NPT	-	6	10	26
½" NPT	-	18,5	15	43
¾" NPT	-	18	15	39

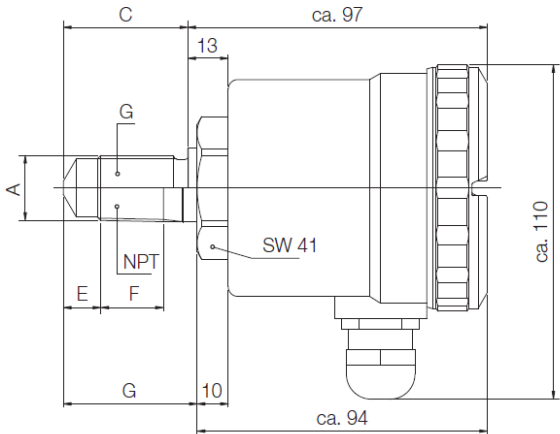

KAL-K

KAL-..4440 with Tri clamp

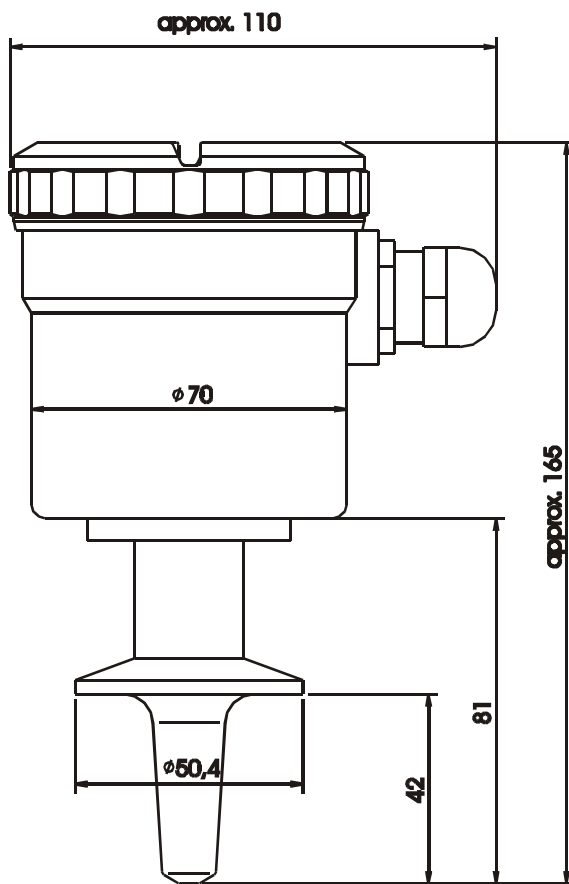

17. EU Declaration of Conformance

We, KOBOLD-Messring GmbH, Hofheim-Ts, Germany, declare under our sole responsibility that the product:

KAL-K Electronic Flow Monitor, 24 V_{DC}, 110 V_{AC/DC}, 230 V_{AC}

to which this declaration relates is in conformity with the standards noted below:

EN 61000-6-4:2011

Electromagnetic compatibility (EMC) - Part 6-4: Generic standards - Emission standard for industrial environments

EN 61000-6-2:2005

Electromagnetic compatibility (EMC) - Part 6-2: Generic standards - Immunity for industrial environments

EN 61010-1:2011

Safety requirements for electrical equipment for measurement, control and laboratory use - Part 1: General requirements

Also the following EC guidelines are fulfilled:

2014/30/EU

EMC Directive

2014/35/EU

Low Voltage Directive

2011/65/EU

RoHS (category 9)

Hofheim, 12. May 2016



H. Peters
General Manager



M. Wenzel
Proxy Holder