

Operating Instructions

Liquiport CSP44

Portable sampler for liquid media

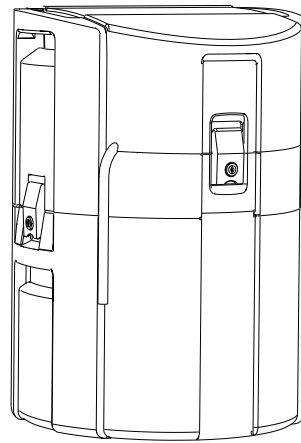

Table of contents



1	About this document	5	9	Commissioning	29
1.1	Warnings	5	9.1	Function check	29
1.2	Symbols	5	9.2	Switching on the measuring device	29
1.3	Symbols on the device	5	9.3	Setting the operating language	30
1.4	Documentation	6	9.4	Configuring the measuring device	30
2	Basic safety instructions	7	10	Operation	35
2.1	Requirements for personnel	7	10.1	Display	35
2.2	Designated use	7	10.2	General settings	36
2.3	Workplace safety	7	10.3	Programming	47
2.4	Operational safety	8	10.4	Inputs	81
2.5	Product safety	9	10.5	Outputs	86
3	Product description	10	11	Diagnostics and troubleshooting ...	94
3.1	Device design	10	11.1	General troubleshooting	94
3.2	Terminal diagram	11	11.2	Diagnostic information on local display	95
4	Incoming acceptance and product identification	12	11.3	Adapting the diagnostic information	95
4.1	Incoming acceptance	12	11.4	Overview of diagnostic information	97
4.2	Product identification	12	11.5	Pending diagnostic messages	104
4.3	Scope of delivery	12	11.6	Diagnosis list	104
4.4	Certificates and approvals	13	11.7	Logbooks	104
5	Installation	14	11.8	Device information	110
5.1	Installation conditions	14	11.9	Simulation	111
5.2	Installation	16	11.10	Device test	113
5.3	Connecting the suction line	16	11.11	Resetting the measuring device	115
5.4	Post-installation check	16	11.12	Information on operating times	115
6	Electrical connection	17	11.13	Status of inputs/outputs	115
6.1	Connecting the sampler	17	11.14	Firmware history	116
6.2	Connecting modules and sensors	19	12	Maintenance	120
6.3	Terminal assignment for input/output signals	19	12.1	Recommended maintenance	120
6.4	Signal cable connection (optional)	20	12.2	Calibration	121
6.5	Ensuring the degree of protection	21	12.3	Replacing the pump tube	122
6.6	Post-connection check	22	12.4	Cleaning	124
7	System integration	23	12.5	Replacing the rechargeable batteries	126
7.1	Service interface	23	12.6	Technical support	127
8	Operation options	24	13	Repair	128
8.1	Overview	24	13.1	Spare parts	128
8.2	Access to the operating menu via the local display	25	13.2	Return	129
8.3	Configuration options	26	13.3	Disposal	129
			14	Accessories	130
			14.1	Measuring cable	131
			14.2	Sensors	131
			15	Technical data	136
			15.1	Input	136
			15.2	Binary input, passive (optional)	136
			15.3	Temperature inputs (optional)	136
			15.4	Analog input, passive/active (optional)	136

15.5	Output optional	136
15.6	Power supply	137
15.7	Performance characteristics	137
15.8	Environment	138
15.9	Process	138
15.10	Mechanical construction	139







Index	141
------------------------	------------

1 About this document

1.1 Warnings

Structure of information	Meaning
<p> DANGER</p> <p>Causes (/consequences) If necessary, Consequences of non-compliance (if applicable)</p> <ul style="list-style-type: none"> ▶ Corrective action 	<p>This symbol alerts you to a dangerous situation. Failure to avoid the dangerous situation will result in a fatal or serious injury.</p>
<p> WARNING</p> <p>Causes (/consequences) If necessary, Consequences of non-compliance (if applicable)</p> <ul style="list-style-type: none"> ▶ Corrective action 	<p>This symbol alerts you to a dangerous situation. Failure to avoid the dangerous situation can result in a fatal or serious injury.</p>
<p> CAUTION</p> <p>Causes (/consequences) If necessary, Consequences of non-compliance (if applicable)</p> <ul style="list-style-type: none"> ▶ Corrective action 	<p>This symbol alerts you to a dangerous situation. Failure to avoid this situation can result in minor or more serious injuries.</p>
<p>NOTICE</p> <p>Cause/situation If necessary, Consequences of non-compliance (if applicable)</p> <ul style="list-style-type: none"> ▶ Action/note 	<p>This symbol alerts you to situations which may result in damage to property.</p>

1.2 Symbols

Symbol	Meaning
	Additional information, tips
	Permitted or recommended
	Not permitted or not recommended
	Reference to device documentation
	Reference to page
	Reference to graphic
	Result of a step

1.3 Symbols on the device

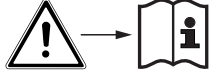
Symbol	Meaning
	Reference to device documentation

1.4 Documentation

The following manuals which are available on the complement these Brief Operating Instructions Operating Instructions:

- Brief Operating Instructions for Liquiport CSP44, BA00465C
- Operating Instructions for Memosens, BA01245C
 - Software description for Memosens inputs
 - Calibration of Memosens sensors
 - Sensor-specific diagnostics and troubleshooting
- Guidelines for communication via fieldbus and web server
- Special Documentation: Sampler application manual SD01068C
- Documentation on other devices in the Liquiline platform:
 - Liquiline CM44xR (DIN rail device)
 - Liquiline System CA80 (analyzer)
 - Liquiline System CAT8x0 (sample preparation)
 - Liquistation CSFxx (sampler)
 - Liquiport CSP44 (sampler)

2 Basic safety instructions

2.1 Requirements for personnel

- Installation, commissioning, operation and maintenance of the measuring system may be carried out only by specially trained technical personnel.
- The technical personnel must be authorized by the plant operator to carry out the specified activities.
- The electrical connection may be performed only by an electrical technician.
- The technical personnel must have read and understood these Operating Instructions and must follow the instructions contained therein.
- Faults at the measuring point may only be rectified by authorized and specially trained personnel.

 Repairs not described in the Operating Instructions provided must be carried out only directly at the manufacturer's site or by the service organization.

2.2 Designated use

Liquiport 2010 CSP44 is a portable sampler for liquid media in non-hazardous areas. The samples are taken discontinuously using a peristaltic pump and are then distributed into sampling containers.

The sampler is designed for use in the following applications:

- Communal and industrial wastewater treatment plants
- Laboratories and water management offices
- Monitoring of liquid media in industrial processes

Use of the device for any purpose other than that described, poses a threat to the safety of people and of the entire measuring system and is therefore not permitted. The manufacturer is not liable for damage caused by improper or non-designated use.

2.3 Workplace safety

As the user, you are responsible for complying with the following safety conditions:

- Installation guidelines
- Local standards and regulations
- Regulations for explosion protection

Electromagnetic compatibility

- The product has been tested for electromagnetic compatibility in accordance with the applicable international standards for industrial applications.
- The electromagnetic compatibility indicated applies only to a product that has been connected in accordance with these Operating Instructions.

2.4 Operational safety

Before commissioning the entire measuring point:

1. Verify that all connections are correct.
2. Ensure that electrical cables and hose connections are undamaged.
3. Do not operate damaged products, and protect them against unintentional operation.
4. Label damaged products as defective.

During operation:

- ▶ If faults cannot be rectified:
products must be taken out of service and protected against unintentional operation.

2.5 Product safety

2.5.1 State of the art

The product is designed to meet state-of-the-art safety requirements, has been tested, and left the factory in a condition in which it is safe to operate. The relevant regulations and international standards have been observed.

Devices connected to the sampler must comply with the applicable safety standards.

2.5.2 IT security

We only provide a warranty if the device is installed and used as described in the Operating Instructions. The device is equipped with security mechanisms to protect it against any inadvertent changes to the device settings.

IT security measures in line with operators' security standards and designed to provide additional protection for the device and device data transfer must be implemented by the operators themselves.

3 Product description

3.1 Device design

A complete sampling unit comprises:

- Controller with display, soft keys and navigator
- Vacuum or peristaltic pump for sampling
- PE or glass sample bottles for sample preservation
- Sampling chamber temperature regulator (optional) for safe sample storage
- Suction line with suction head

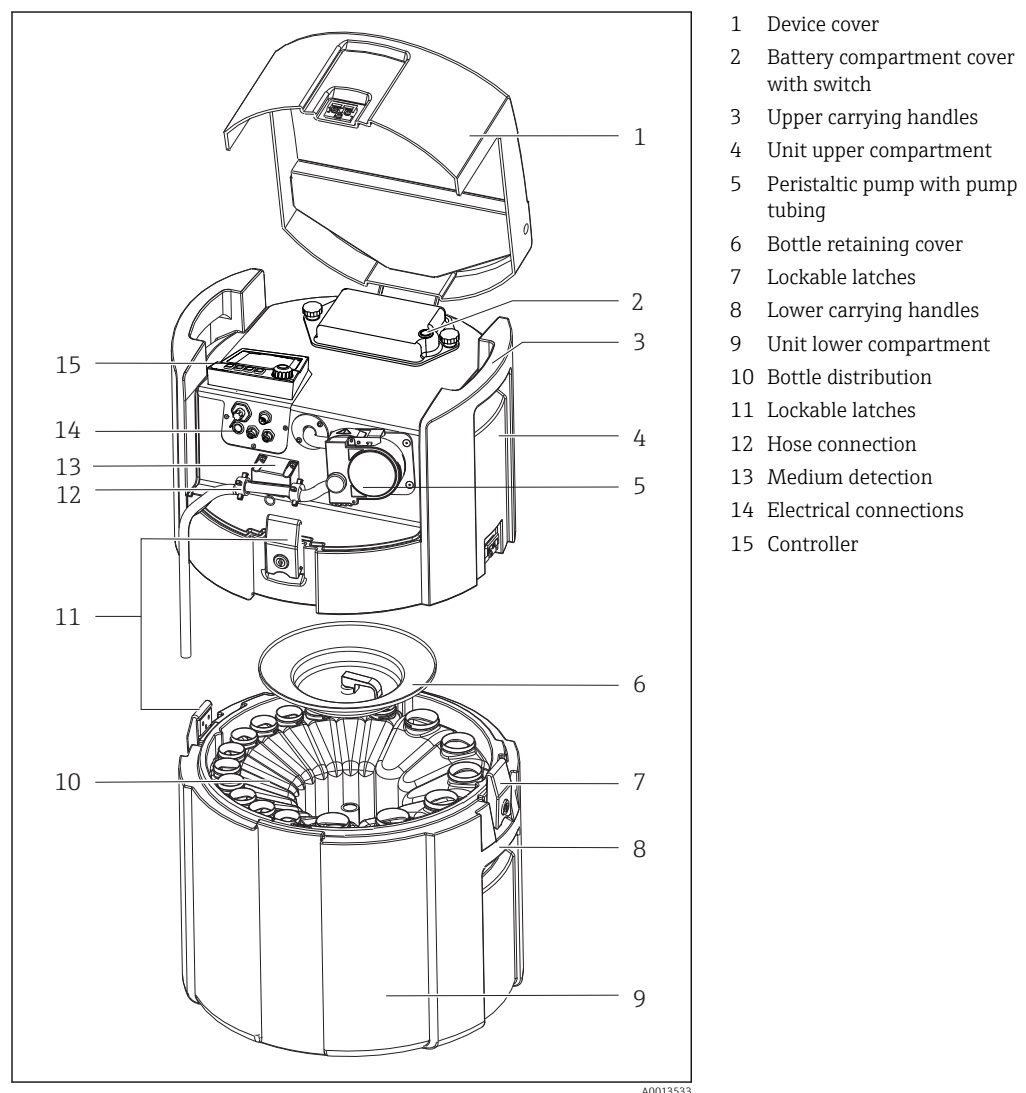

⚠ WARNING

Risk of injury

Danger of injury due to rotating parts

- ▶ Secure the sampler against unintentional start-up whilst you work on the opened hose pump.

3.2 Terminal diagram

 The unique terminal name is derived from:

Slot no. : Port no. : Terminal

Example, NO contact of a relay

Device with inputs for digital sensors, 4 current outputs and 4 relays

- Base module BASE2-E (contains 2 sensor inputs, 2 current outputs)
- 2AO module (2 current outputs)
- 4R module (4 relays)

4 Incoming acceptance and product identification

4.1 Incoming acceptance

1. Verify that the packaging is undamaged.
 - ↳ Notify the supplier of any damage to the packaging.
Keep the damaged packaging until the issue has been resolved.
2. Verify that the contents are undamaged.
 - ↳ Notify the supplier of any damage to the delivery contents.
Keep the damaged goods until the issue has been resolved.
3. Check that the delivery is complete and nothing is missing.
 - ↳ Compare the shipping documents with your order.
4. Pack the product for storage and transportation in such a way that it is protected against impact and moisture.
 - ↳ The original packaging offers the best protection.
Make sure to comply with the permitted ambient conditions.

If you have any questions, please contact your supplier or your local Sales Center.

4.2 Product identification

Nameplates can be found:

- On the inside of the door
- On the packaging (adhesive label, portrait format)
- On the inside of the device cover

4.2.1 Nameplate

The nameplate provides you with the following information on your device:

- Manufacturer identification
 - Order code
 - Extended order code
 - Serial number
 - Firmware version
 - Ambient and process conditions
 - Input and output values
 - Activation codes
 - Safety information and warnings
 - Certificate information
- ▶ Compare the information on the nameplate with the order.

4.3 Scope of delivery

The scope of delivery comprises:

- 1 Liquiport 2010 CSP44 with:
 - The ordered bottle configuration
 - Optional hardware
 - 1 print version of Brief Operating Instructions in the language ordered
 - Optional accessories
- ▶ If you have any queries:
Please contact your supplier or local sales center.

4.4 Certificates and approvals

4.4.1 CE mark

Declaration of Conformity

The product meets the requirements of the harmonized European standards. As such, it complies with the legal specifications of the EU directives. The manufacturer confirms successful testing of the product by affixing to it the **CE** mark.

MCERTS

The device has been assessed by Sira Certification Service and complies with "MCERTS Performance Standards for Water Monitoring Equipment Part 1, Version 2.1 dated November 2009"; certificate no.: Sira MC100176/02.

EAC

The product has been certified according to guidelines TP TC 004/2011 and TP TC 020/2011 which apply in the European Economic Area (EEA). The EAC conformity mark is affixed to the product.

5 Installation

5.1 Installation conditions

5.1.1 Dimensions

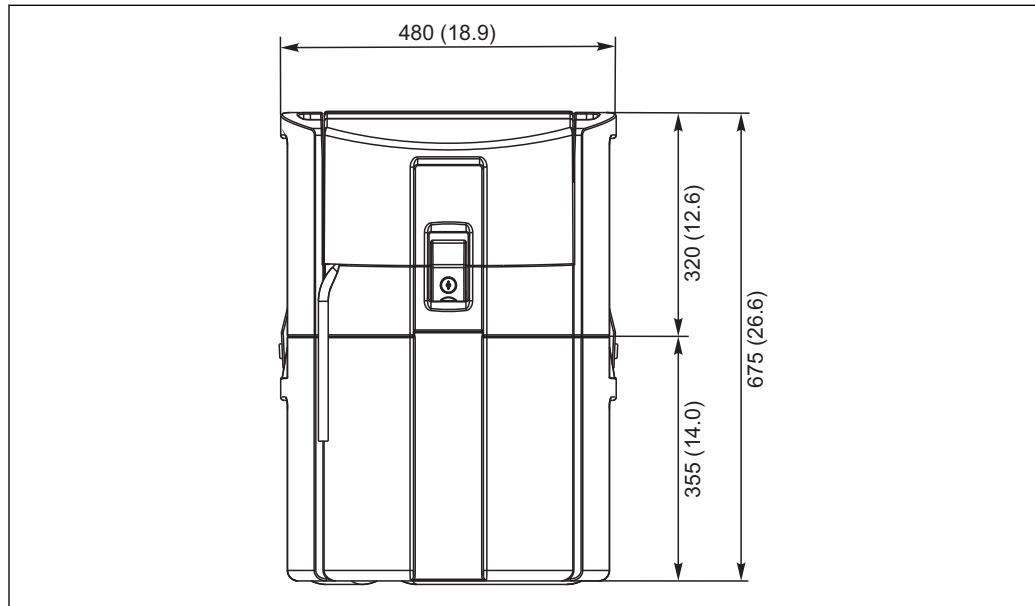

A0013473

1 CSP44 standard version, dimensions in mm (in)

5.1.2 Installation site

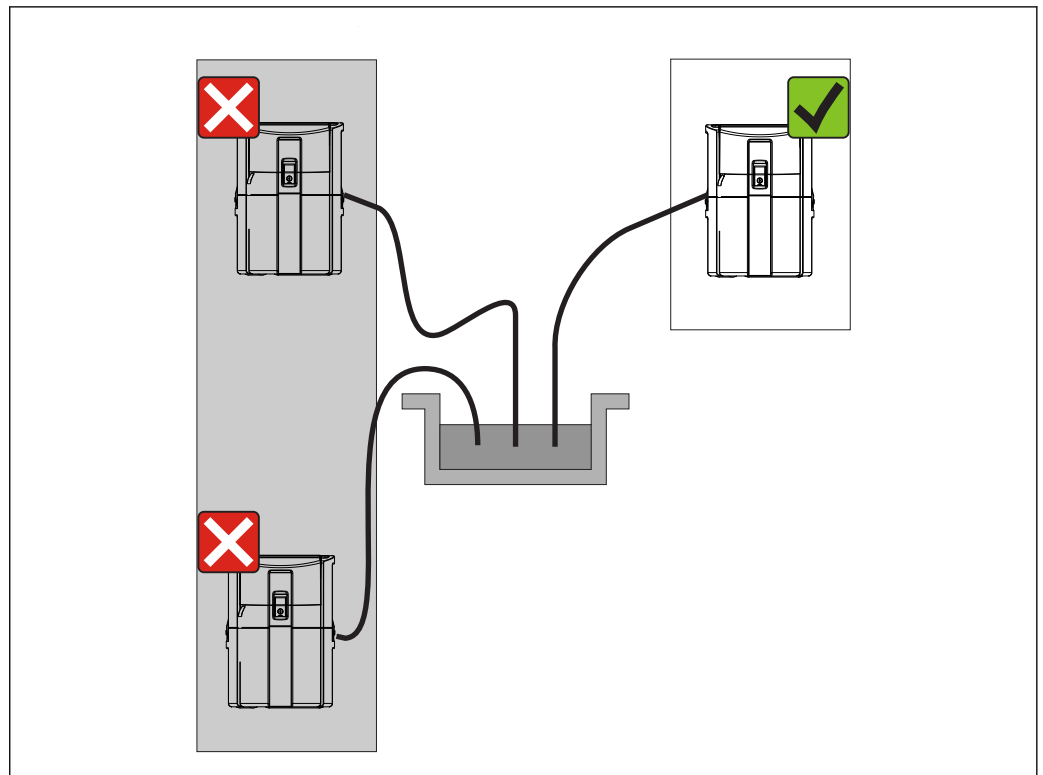

2 Installation site, example

A0013474

i The suction line must be routed with a downward slope to the sampling point. Avoid siphon formation!

Note the following when erecting the device:

- Erect the device on a level surface.
- Securely connect the device at the fastening points to the surface underneath.
- Protect the device against additional heating (e.g. heater or direct sunlight in the case of PS housing).
- Protect the device against mechanical vibrations.
- Protect the device against strong magnetic fields.

5.1.3 Connection for suctioning samples

- Maximum suction height: 8 m (26 ft)
- Maximum hose length: 30 m (98 ft)
- Diameter of hose connection: 10 mm (3/8") internal diameter
- Intake speed:
 - > 0.5 m/s (> 1.6 ft/s) as per EN 25667, ISO 5667
 - > 0.6 m/s (> 1.9 ft/s) as per Ö 5893, US EPA

Note the following when erecting the device:

- Always route the suction line so that it slopes upwards from the sampling point to the sampler.
- The sampler must be located above the sampling point.
- Avoid siphoning effects in the suction line.

Requirements for the sampling point:

- Do not connect the suction line to pressurized systems.
- Use the suction filter to impede coarse and abrasive solids and solids which can cause clogging.
- Immerse the suction line in the direction of flow.
- Take the sample at a representative point (turbulent flow, not directly at the bottom of the channel).

Useful sampling accessories

Suction filter:

Impedes coarser solids and solids which can cause clogging.

5.1.4 Connection for sample intake on version with sample pump

- Maximum suction height: 8 m (26 ft)
- Maximum hose length: 30 m (98 ft)
- Diameter of hose connection: 10 mm (3/8") internal diameter
- Intake speed:
 - > 0.5 m/s (> 1.6 ft/s) as per EN 25667, ISO 5667
 - > 0.6 m/s (> 1.9 ft/s) as per Ö 5893, US EPA

Note the following when erecting the device:

- Always route the suction line so that it slopes upwards from the sampling point to the sampler.
- The sampler must be located above the sampling point.
- Avoid siphoning effects in the suction line.

Requirements for the sampling point:

- Do not connect the suction line to pressurized systems.
- Use the suction filter to impede coarse and abrasive solids and solids which can cause clogging.
- Immerse the suction line in the direction of flow.
- Take the sample at a representative point (turbulent flow, not directly at the bottom of the channel).

Useful sampling accessories

Suction filter:

Impedes coarser solids and solids which can cause clogging.

5.2 Installation**5.3 Connecting the suction line**

1. When installing the device, take the installation conditions into account.
2. Open the device cover at the front fastening clasp.
3. Route the suction line from the sampling point to the device.
4. Screw the suction line onto the device's hose connection.

5.4 Post-installation check

1. Verify that the suction line is securely connected to the device.
2. Visually check that the suction line is installed correctly from the sampling point to the device.
3. Verify that the rotating arm is correctly engaged.

6 Electrical connection

6.1 Connecting the sampler

⚠ WARNING

Device is live!

Incorrect connection may result in injury or death!

- ▶ The electrical connection may be performed only by an electrical technician.
- ▶ The electrical technician must have read and understood these Operating Instructions and must follow the instructions contained therein.
- ▶ **Prior** to commencing connection work, ensure that no voltage is present on any cable.

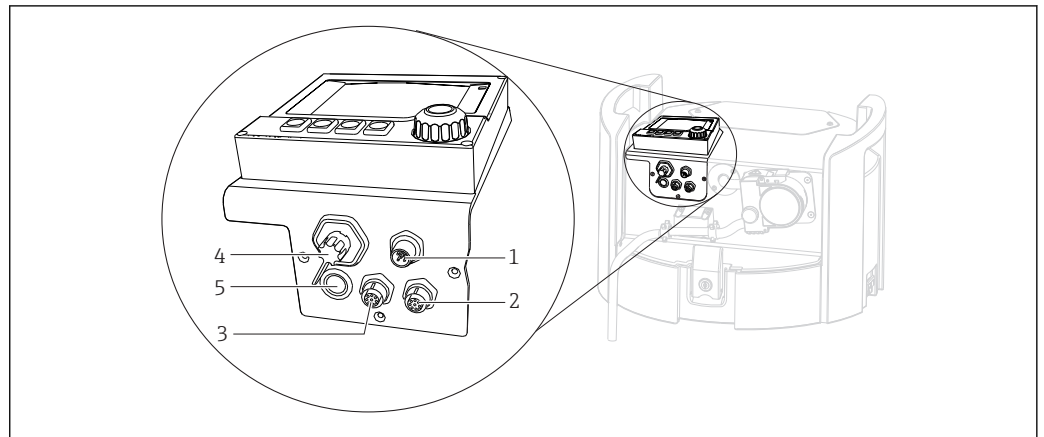

A0029150

3 Electrical connections of the controller

- 1 Connection socket for charger
- 2 Socket for M12 sensor connector (optional)
- 3 Socket for M12 sensor connector (optional)
- 4 Connection socket for signal cable (optional)
- 5 Service interface

i The polarity of the switch connections does not have to be taken into account.

6.1.1 Charging the battery

NOTICE

Defective batteries

The batteries can be destroyed if they are discharged completely.

- ▶ To prevent complete discharge, move the switch to the "OFF" position.

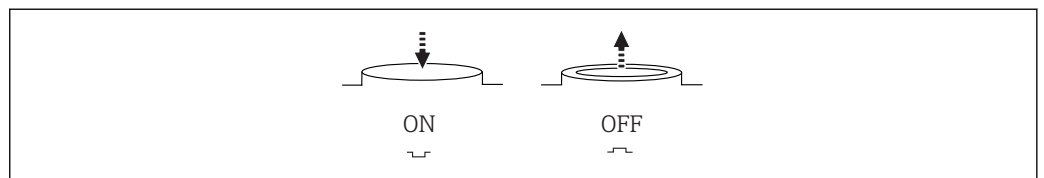

A0035816

4 Switch position

Charge the battery before initial commissioning. It takes approx. 5 hours to fully charge the battery. Please refer to the charger's operating manual for detailed information on the charger.

- ▶ Connect the device with the mains plug to the supply voltage.
 - ↳ The battery starts charging as soon as the power unit is connected, regardless of the switch position.

i Only replace batteries with the following battery type: Panasonic LC-R127R2PG1.

Connecting the charger when the batteries are installed

The mains plug of the charger must be easily accessible so that the charger can be easily disconnected from the power supply.

- ▶ Connect the battery charger to the connection socket (item 1). If the battery is not fully charged, it is recharged by the charger.

i Only use the chargers specified by the manufacturer. →  136

Connecting the charger when the batteries are removed

If you are charging batteries that have been removed, you require the adapter cable (accessory no.: 71111882) to connect to the charger.

6.1.2 Removing the cover

⚠ WARNING

Device is live

Incorrect connection may result in injury or death

- ▶ If a power unit or charger is connected, disconnect it from the power supply.

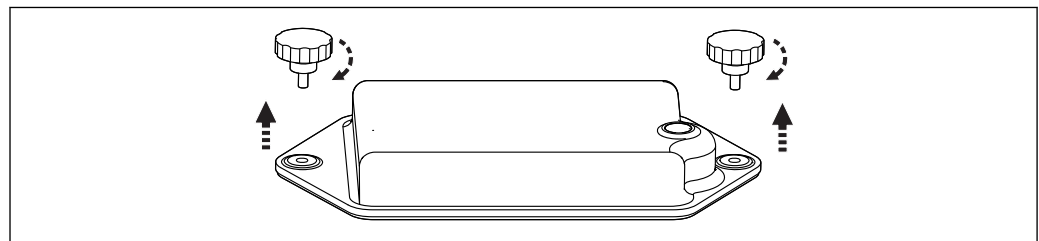

A0035817

1. Release both securing screws.
2. Remove the cover of the battery compartment.
3. Remove the old batteries and release the plug-in connections.
4. Connect the new batteries (pay attention to the battery polarity).
5. Insert the new batteries and secure the battery compartment cover.

6.2 Connecting modules and sensors

6.2.1 Connecting the sensors

Sensor connection

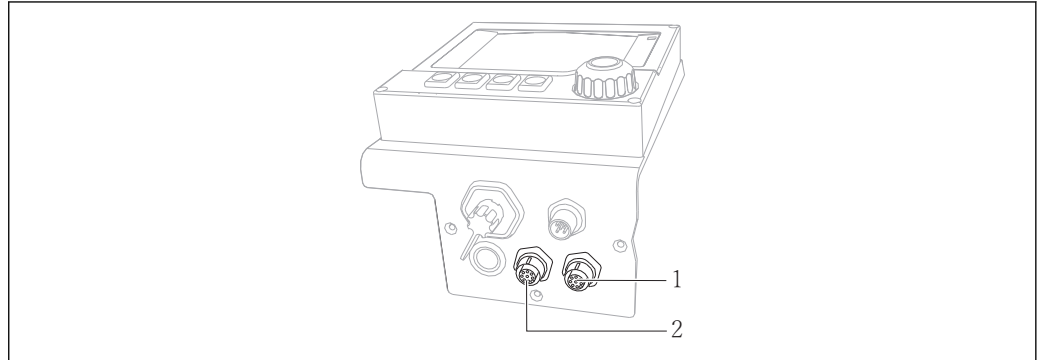

5 Connection sockets for sensors

- 1 Socket for M12 sensor connector (= channel 1 for version with one sensor)
- 2 Socket for M12 sensor connector (= channel 2 for version with two sensors)

6.3 Terminal assignment for input/output signals

Input signals

- 2 analog signals 0/4 to 20 mA (optional)
- 2 binary signals > 100 ms pulse width or edge (optional)
 - Signals of digital sensors with Memosens protocol (optional)

Output signals

- 2 binary signals > 1 s pulse width or edge (optional)
- 2 current outputs 0/4 to 20 mA (optional)

6.4 Signal cable connection (optional)

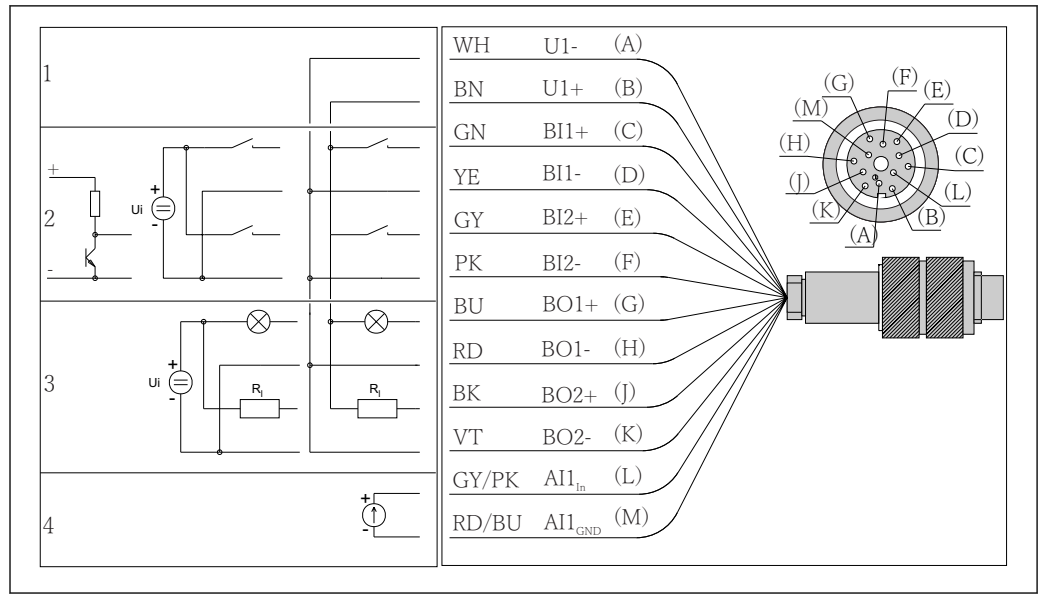

A0014162

6 Pin assignment and wiring diagram of signal cable (version K3)

- 1 Auxiliary voltage U: 24 V max. 30 mA load capacity
- 2 Binary inputs BI: > 20 ms, only extra-low voltage $U_i \leq 30$ V DC
- 3 Binary outputs BO: only extra-low voltage $U_i \leq 30$ V DC, max. current when using ext. auxiliary voltage (max. 200 mA)
- 4 Analog input AI: 0 to 20 mA, 4 to 20 mA

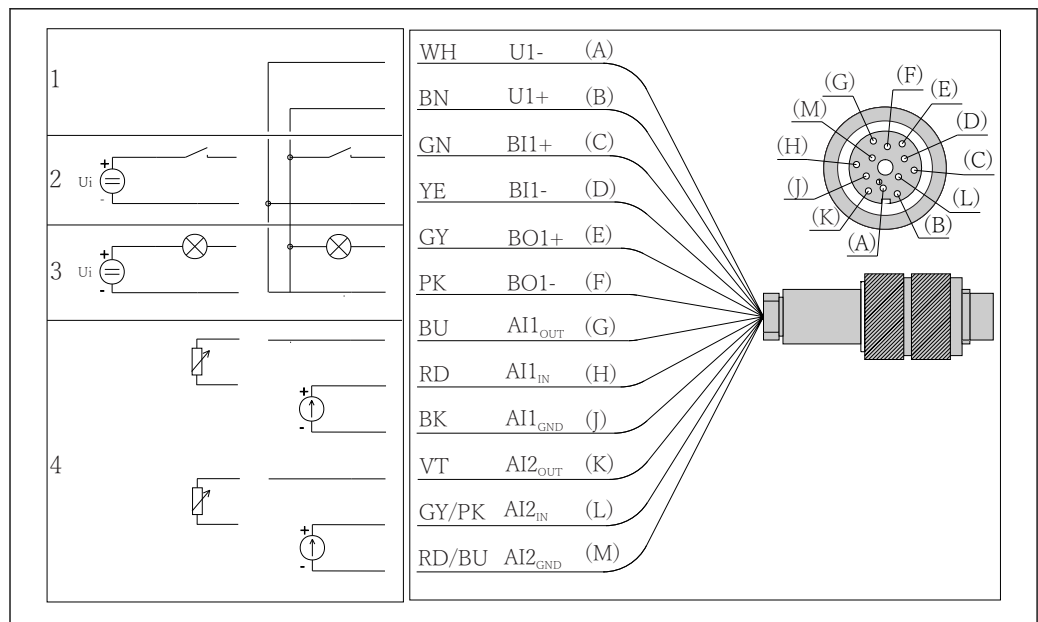

A0014197

7 Pin assignment and wiring diagram of signal cable (version K4)

- 1 Auxiliary voltage U: 24 V max. 30 mA load capacity
- 2 Binary input BI: > 20 ms, only extra-low voltage $U_i \leq 30$ V DC
- 3 Binary output BO: only extra-low voltage $U_i \leq 30$ V DC, max. current when using ext. auxiliary voltage (max. 200 mA)
- 4 Analog inputs AI: 0 to 20 mA, 4 to 20 mA

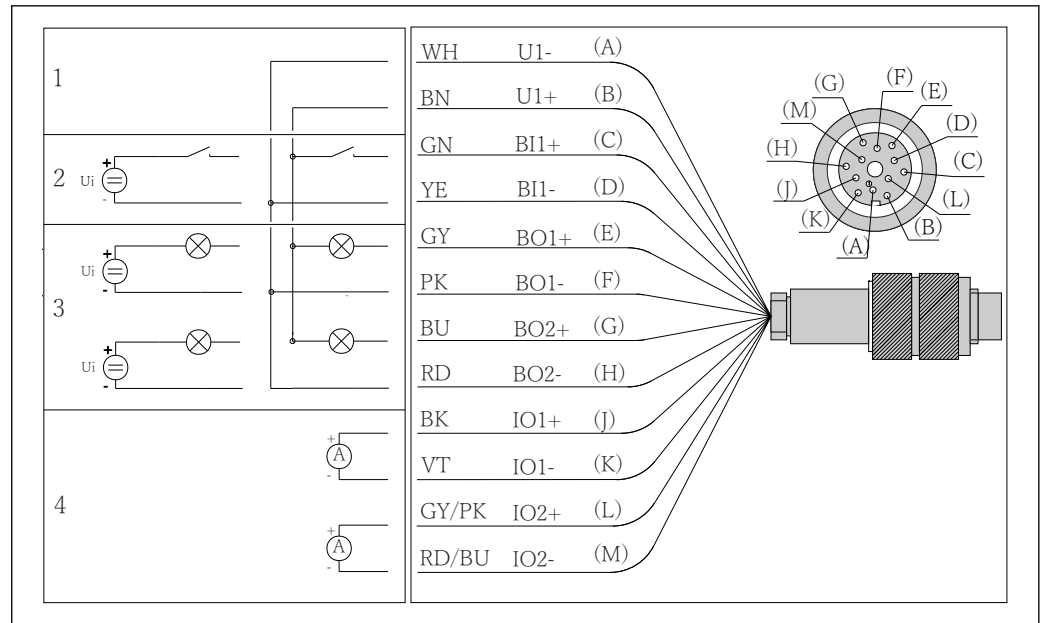

A0014198

8 Pin assignment and wiring diagram of signal cable (version K5)

- 1 Auxiliary voltage U : 24 V max. 30 mA load capacity
- 2 Binary input BI: > 20 ms, only extra-low voltage U_i £ 30 V DC
- 3 Binary output BO: only extra-low voltage U_i £ 30 V DC, max. current when using ext. auxiliary voltage (max. 200 mA)
- 4 Analog inputs AI: 0 to 20 mA, 4 to 20 mA

6.5 Ensuring the degree of protection

Only the mechanical and electrical connections which are described in these instructions and which are necessary for the required, designated use, may be carried out on the device delivered.

- ▶ Exercise care when carrying out the work.

Individual types of protection permitted for this product (impermeability (IP), electrical safety, EMC interference immunity, Ex protection) can no longer be guaranteed if, for example :

- Covers are left off
- Different power units to the ones supplied are used
- Cable glands are not sufficiently tightened (must be tightened with 2 Nm (1.5 lbf ft) for the permitted level of IP protection)
- Unsuitable cable diameters are used for the cable glands
- Modules are not fully secured
- The display is not fully secured (risk of moisture entering due to inadequate sealing)
- Loose or insufficiently tightened cables/cable ends
- Conductive cable strands are left in the device

6.6 Post-connection check

WARNING

Connection errors

The safety of people and of the measuring point is at risk! The manufacturer does not accept any responsibility for errors that result from failure to comply with the instructions in this manual.

- ▶ Put the device into operation only if you can answer **yes** to **all** the following questions.

Instrument status and specifications

- ▶ Are the device and all the cables free from damage on the outside?

Electrical connection

- ▶ Are the mounted cables strain relieved?
- ▶ Are the cables routed without loops and cross-overs?
- ▶ Are the signal cables correctly connected as per the wiring diagram?
- ▶ Are all plug-in terminals securely engaged?
- ▶ Are all the connection wires securely positioned in the cable terminals?

7 System integration

7.1 Service interface

You can connect the device to a computer via the service interface and configure it using "FieldCare". Furthermore, configurations can also be saved, transferred and documented.

7.1.1 Connection

1. Connect the service connector to the interface on the Liquiline base module and connect it to the Commubox.
2. Connect the Commubox via the USB connection to the computer on which FieldCare is installed.

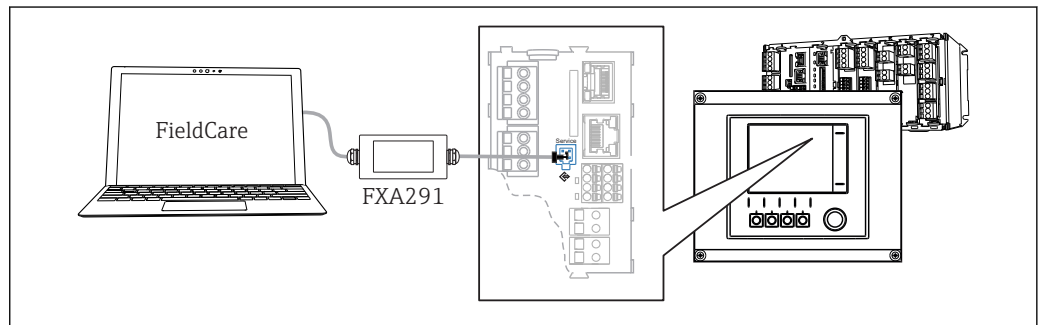

9 Connection overview

A0039618

7.1.2 Establishing the data connection

1. Start FieldCare.
2. Establish a connection to the Commubox. To do so, select the "CDI Communication FXA291" ComDTM.
3. Then select the "Liquiline CM44x" DTM and start configuration.

You can now start online configuration via the DTM.

Online configuration competes with onsite operation, i. e. each of the two options blocks the other one. On both sides it is possible to take away access from the other side.

7.1.3 Operation

- In the DTM the menu structure corresponds to the onsite operation. The functions of the Liquiline soft keys are found in the main window on the left.
- Clicking a menu name or a function corresponds to pressing the navigator.
- You can make your settings conveniently via the computer keyboard.
- You can use FieldCare to save logbooks, make backups of configurations and transfer configurations to other devices.
- You can also print out configurations or save them as PDFs.

8 Operation options

8.1 Overview

8.1.1 Display and operating elements

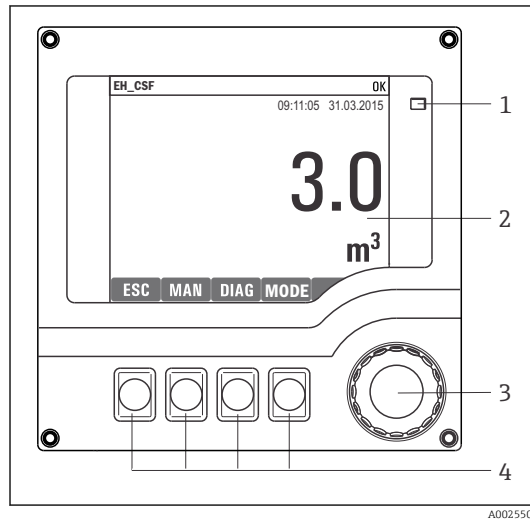

- 1 LED
- 2 Display (with red display background in alarm condition)
- 3 Navigator (jog/shuttle and press/hold function) Soft keys (function depends on menu)
- 4

10 Overview of operation

8.1.2 Display

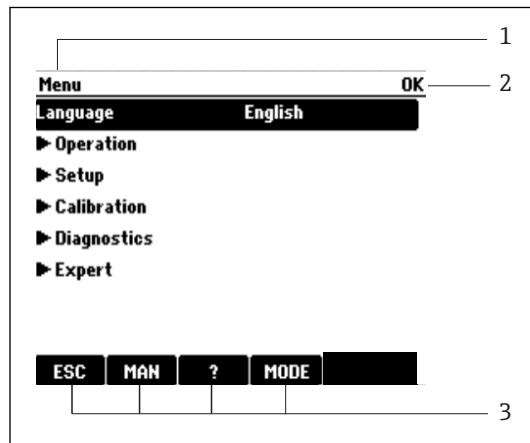

- 1 Menu path and/or device designation
- 2 Status display
- 3 Assignment of soft keys, e. g.:
 ESC: escape or abortion of a sampling process
 MAN: manual sample
 ?: Help, if available
 MODE: switch the device to standby or cancel the program

11 Display (example)

8.2 Access to the operating menu via the local display

8.2.1 Operating concept

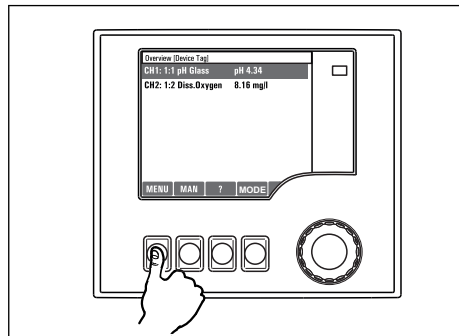

Pressing the soft key: selecting the menu directly

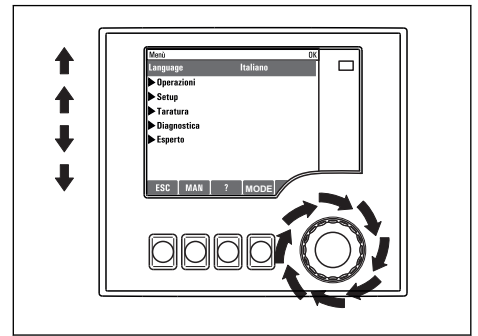

Turning the navigator: moving the cursor in the menu

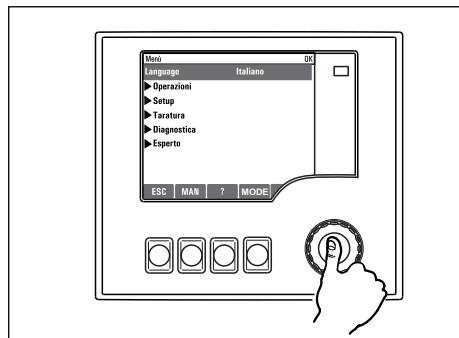

Pressing the navigator: launching a function

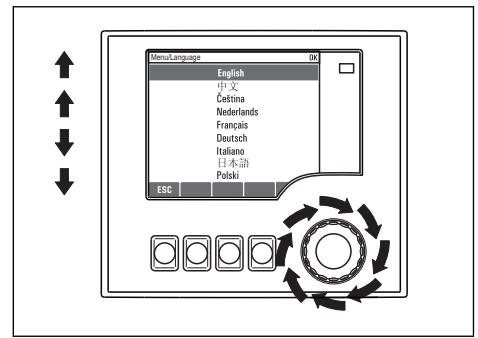

Turning the navigator: selecting a value (e.g. from a list)

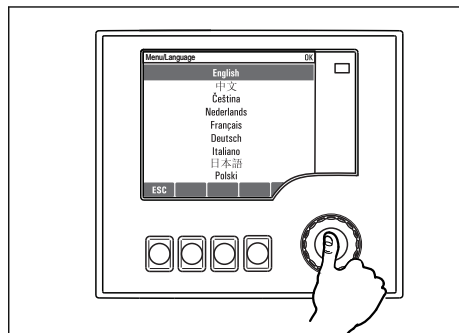

Pressing the navigator: accepting the new value

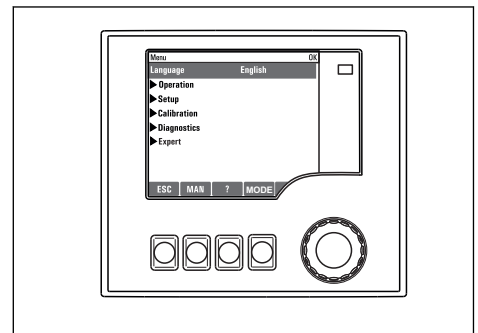

↳ New setting is accepted

8.2.2 Locking or unlocking operating keys

Locking operating keys

- ▶ Press the navigator for longer than 2 s.
 - ↳ A context menu for locking the operating keys is displayed.

You have the choice of locking the keys with or without password protection. "With password" means that you can only unlock the keys again by entering the correct

password. This password is set here: **MenuSetupGeneral settingsExtended setupData managementChange lock password**

- ▶ Choose whether you want to lock without or without a password.
 - ↳ The keys are locked. No more entries can be made. In the soft key bar, you will see the  symbol.

 The password is 0000 when the device is delivered from the factory. **Make sure to note down any changes to the password**, as otherwise you will not be able to unlock the keypad yourself.

Unlocking operating keys

1. Press the navigator for longer than 2 s.
 - ↳ A context menu for unlocking the operating keys is displayed.
2. Select **Key unlock**
 - ↳ The keys are unlocked immediately if you did not choose to lock with a password. Otherwise you are asked to enter your password.
3. Only if keypad is password-protected: enter the right password.
 - ↳ The keys are unlocked. It is possible to access the entire onsite operation again. The  symbol is no longer visible on the display.

 The password is 0000 when the device is delivered from the factory. **Make sure to note down any changes to the password**, as otherwise you will not be able to unlock the keypad yourself.

8.3 Configuration options

8.3.1 Display only

- You can only read the values but cannot change them.
- Typical read-only values are: sensor data and system information
- Example: **Menu/Setup/Inputs/./Sensor type**

8.3.2 Picklists

- You receive a list of options. In a few cases, these also appear in the form of multiple choice boxes.
- Usually you just select one option; in rare instances you select one or more options.
- Example: **Menu/Setup/General settings/Temperature unit**

8.3.3 Numerical values

- You are changing a variable.
- The maximum and minimum values for this variable are shown on the display.
- Configure a value within these limits.
- Example: **Menu/Operation/Display/Contrast**

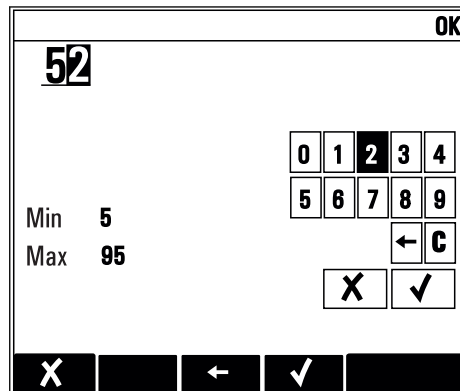

8.3.4 Actions

- You trigger an action with the appropriate function.
- You know that the item in question is an action if it is preceded by the following symbol: \blacktriangleright
- Examples of typical actions include:
 - Deleting log entries
 - Saving or loading configurations
 - Triggering cleaning programs
- Examples of typical actions include:
 - Start a sampling program
 - Start manual sampling
 - Saving or loading configurations
- Example: **Menu/Manual sampling/Start sampling**

8.3.5 Free text

- You are assigning an individual designation.
- Enter a text. You can use the characters in the editor for this purpose (upper-case and lower-case letters, numbers and special characters).
- Using the soft keys, you can:
 - Cancel your entries without saving the data (X)
 - Delete the character in front of the cursor (✕)
 - Move the cursor back one position (←)
 - Finish your entries and save (✓)
- Example: **Menu/Setup/General settings/Device tag**

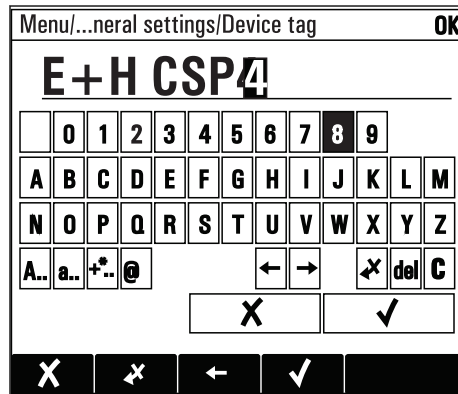

8.3.6 Tables

- Tables are needed to map mathematical functions or to enter irregular interval samples.
- You edit a table by navigating through rows and columns with the navigator and changing the values of the cells.
- You only edit the numerical values. The controller automatically takes care of the engineering units.
- You can add lines to the table (**INSERT**) or delete lines from the table (**DEL**).
- Afterwards, you save the table (**SAVE**).
- You can also cancel your entries any time using the X soft key.
- Example: **Menu/Setup/Inputs/pH/Medium comp.**

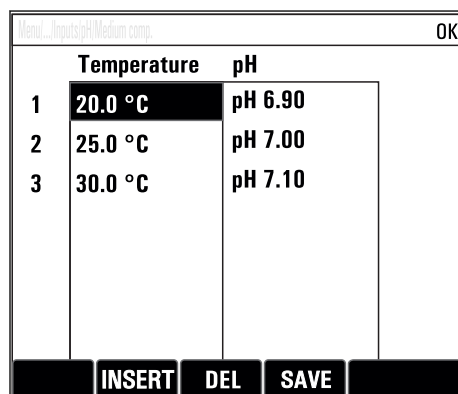

9 Commissioning

9.1 Function check

⚠ WARNING

Incorrect connection, incorrect supply voltage

Safety risks for staff and device malfunctions!

- ▶ Check that all connections have been established correctly in accordance with the wiring diagram.
- ▶ Ensure that the supply voltage matches the voltage indicated on the nameplate.



Saving displays as a screenshot

Via the local display, you can take screenshots at any time and save them to an SD card.

1. Insert an SD card into the SD card slot in the basic module.
2. Press the navigator button for at least 3 seconds.
3. In the context menu select the "Screenshot" item.
 - ↳ The current screen is saved as a bitmap file to the SD card in the "Screenshots" folder.

9.2 Switching on the measuring device

The device is delivered with a built-in rechargeable battery. The switch in the battery cover is set to "OFF".

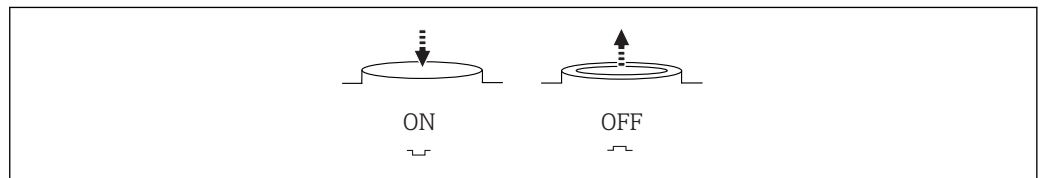

A0035816

12 Switch position

1. Prior to initial commissioning, charge the batteries by connecting the power unit.
 - ↳ The battery starts charging as soon as the power unit is connected, regardless of the switch position. It takes approx. 5 hours to fully charge the battery. Please refer to the charger's operating manual for detailed information on the charger.
2. Once the charging process is complete, press the switch on the battery cover to the "ON" position.
 - ↳ The transmitter starts up.
3. Wait for the boot process to complete.

Disconnecting the batteries when the sampler is not in use:

- ▶ Press the switch on the battery cover to the "OFF" position.
 - ↳ When the switch is in the "OFF" position, it provides reliable and effective protection against the battery discharging completely and thus becoming irreparably damaged.

9.3 Setting the operating language

Configuring the language

If you have not already done so, close the housing cover and screw the device closed.

1. Connect the rechargeable battery (see "Electrical connection" section).
 - ↳ Wait for the initialization to finish.
2. Press the soft key **MENU**. Set your language in the top menu item.
 - ↳ The device can now be operated in your chosen language.

9.4 Configuring the measuring device

9.4.1 Start screen

You can find the following menu items and soft keys on the initial screen:

- **Select sampling program**
- **Edit program %OV¹⁾**
- **Start program %OV¹⁾**
- **MENU**
- **MAN**
- **MEAS**
- **MODE**

9.4.2 Display behavior

Menu/Operation/Display		
Function	Options	Info
Contrast	5 to 95 % Factory setting 50 %	Adjust the screen settings to suit your working environment. Backlight = Automatic
Backlight	Selection <ul style="list-style-type: none"> ▪ On ▪ Off ▪ Automatic Factory setting Automatic	The backlighting is switched off automatically after a short time if a button is not pressed. It switches back on again as soon as you press the navigator button. Backlight = On The backlighting does not switch off automatically.
Screen rotation	Selection <ul style="list-style-type: none"> ▪ Manual ▪ Automatic Factory setting Manual	If Automatic is selected, the single-channel measured value display switches from one channel to the next every second.
Current program:	Read only	The name of the sampling program currently selected is displayed.
Status	Read only	Active The sampling program has been started and the device takes a sample as per the set parameters. Inactive No sampling program has been started, or a program that was running has been stopped.
▷ Start	Action	The selected sampling program is started.

1) "%OV" here stands for text that depends on the context. This text is generated automatically by the software and inserted in place of %OV.

Menu/Operation/Display		
Function	Options	Info
► Measurement		Current measured values at the inputs are displayed. Analog and binary inputs cannot be modified here.
► Show summary of current program		The bottle statistics for the sampler are displayed. The statistics appear for each individual bottle after the start of the program. You can find more information in the Chap. "Bottle statistics".
► Show summary of inputs		The configured counters of the analog and binary input are displayed. Max. 8 lines

9.4.3 User definable screens

Menu/Operation/User definable screens		
Function	Options	Info
► Meas. screen 1 ... 6		You can create 6 measuring screens of your own and give them a name. The functions are identical for all 6 measuring screens.
Meas. screen	Selection <ul style="list-style-type: none"> ▪ On ▪ Off Factory setting Off	Once you have defined your own measuring screen, you can switch it on here. You can find the new screen under User definable screens .
Label	Customized text, 20 characters	Name of the measuring screen Appears in the status bar of the display.
Number of lines	1 to 8 Factory setting 8	Specify the number of measured values displayed.
► Line 1 ... 8	User interface Label	Specify the content of Label in the submenu of each line.
Source of data	Selection <ul style="list-style-type: none"> ▪ None ▪ See list in "Info" column Factory setting None	► Select a source of data. You can choose from the following: <ul style="list-style-type: none"> ▪ Sensor inputs ▪ Binary inputs ▪ Current inputs ▪ Temperature ▪ Memosens sensor input (optional) ▪ Fieldbus signals ▪ Mathematical functions ▪ Binary inputs and outputs ▪ Current outputs ▪ Relay ▪ Measuring range switching
Measured value <i>Source of data is an input</i>	Selection Depends on the input Factory setting None	You can display different main, secondary and raw measured values depending on the type of input. No options can be selected for outputs here.

Menu/Operation/User definable screens		
Function	Options	Info
Label	Customized text, 20 characters	User-defined name for the parameter to be displayed
▷ Set label to "%OV" ¹⁾	Action	If you perform this action you accept the parameter name that is automatically suggested. Your own parameter name (Label) is lost!

1) "%OV" here stands for text that depends on the context. This text is generated automatically by the software and inserted in place of %OV. In the simplest situations, the generated text could be the name of the measuring channel, for example.

9.4.4 Basic setup

Making basic settings

1. Switch to the **Setup/Basic setup** menu.
 - ↳ Make the following settings.
2. **Device tag:** Give your device any name of your choice (max. 32 characters).
3. **Set date:** Correct the set date if necessary.
4. **Set time:** Correct the set time if necessary.
5. **Number of bottles:** Correct the set number of bottles if necessary.
6. **Bottle volume:** Correct the set bottle volume if necessary.
 - ↳ For quick commissioning, you can ignore the additional settings for outputs etc. You can make these settings later in the specific menus.
7. To return to the display overview: press the soft key for **ESC** for at least one second.
 - ↳ Your sampler now works with your basic settings.

If you wish to configure your most important input and output parameters in the **Basic setup** :

- ▶ Configure the current inputs, limit switches, cleaning cycles and device diagnostics with the following submenus.

9.4.5 Sampling programs

Difference between program types

The following box provides an overview of the differences between the Basic, Standard and Advanced program types.

Basic (1 sampling program)		
Start condition: <ul style="list-style-type: none"> ▪ Immediate ▪ Date/time 	<ul style="list-style-type: none"> ▪ Immediate activation ▪ Time-paced, volume-paced or flow-paced (CTCV, VTCV, CTVV), external signal, ▪ Bottle change after time or number of samples, external signal ▪ Bottle synchronization ▪ Multiple bottles 	Stop condition: <ul style="list-style-type: none"> ▪ Program end ▪ Continuous operation

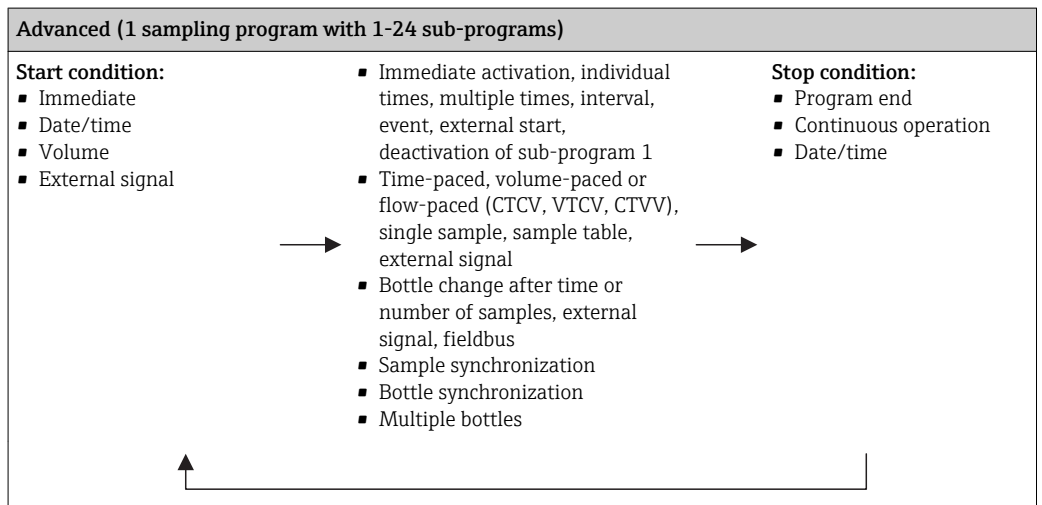
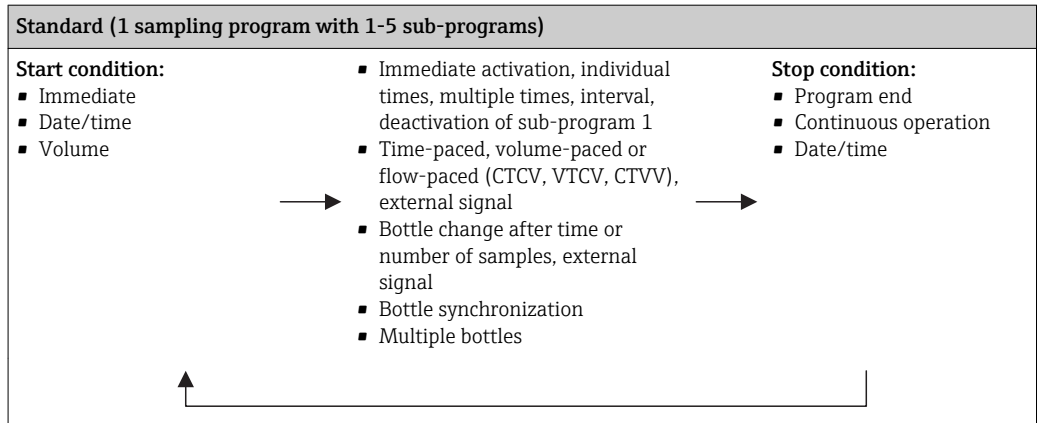

Manual sampling

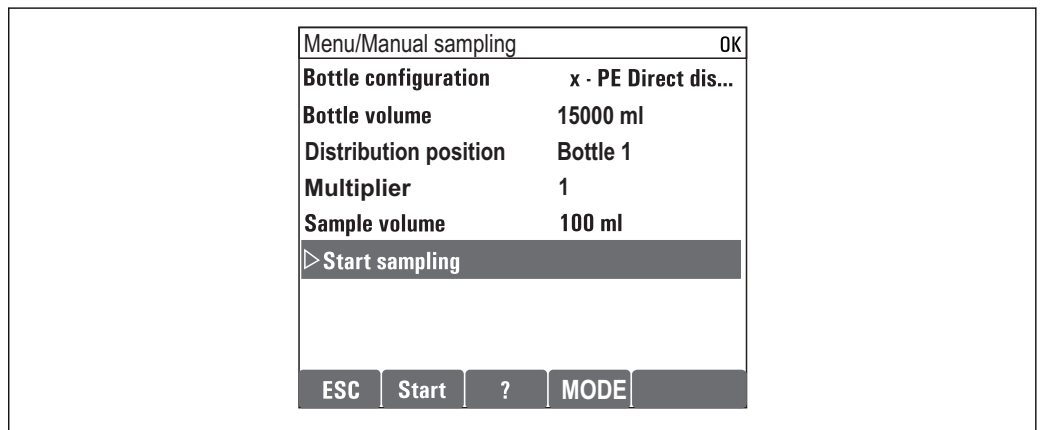

A0036865-EN

1. Manual sampling is triggered by the **MAN** soft key. This pauses any program currently running.
 - ↳ The current bottle configuration and the current sample volume are displayed. You can select the distributor position. In peristaltic systems, you can also change the sample volume. In vacuum systems, **Multiplier** a multiple of a single manual sample can be taken under . Specification of **Multiplie**rrange of adjustment 1 to 50.
2. Select **Start sampling**
 - ↳ A new screen is displayed indicating the progress of the sampling process.

3. After manual sampling, a running program can be displayed and continued with the ESC **ESC** button.
 - ↳ The sample volume for "Manual sampling" is not taken into account in the calculated bottle volumes.

Programming for automatic sampling

Create a simple sampling program in the general overview under **Select sampling program/New/Basic** or in the menu **Menu/Setup/Sampling programs/Setup program/New/Basic** :

1. Enter the "Program name".
2. The settings from the **Basic setup** for bottle configuration and bottle volume are displayed.
3. **Sampling mode=Time paced CTCV** is preset.
4. Enter the **Sampling interval** .
5. Enter the **Sampling volume** per sample. (For version with vacuum pump, configure under **Menu/Setup/General settings/Sampling** .)
6. Select the **Bottle change mode** after number of samples or time for average samples.

i With the option "Bottle change after a time", you can enter the change time and bottle synchronization (None, 1st bottle change time, 1st time of change + bottle number). The description for this can be found in the "Bottle synchronization" section.

i With the option "Bottle change after a time", you can choose the bottle synchronization before the start condition (None, 1st bottle change time, 1st time of change + bottle number). The description for this can be found in the "Bottle synchronization" section.

1. For **Multiple bottles** enter the number of bottles the sample should be distributed over.
2. **Start condition**: immediately or after date/time
3. **Stop condition**: after program end or continuous operation.
4. Pressing the **SAVE** saves the program and ends data entry.
 - ↳ Example:

Menu/... programs/Setup program		OK
Program name:	Program4	
Bottle configuration	2x - PE Direct dis...	
Bottle volume	15000 ml	
Sampling mode	Time paced CTCV	
Sampling interval	10 min	
Sampling volume	100 ml	
Samples per bottle	144	
Start condition	Immediate	
ESC	SAVE	? MODE

A0029242-EN

The program can be started.

10 Operation

10.1 Display

10.1.1 Measuring mode

- ▶ To display the measured values, press the soft key **MEAS** in the start screen, or during operation press **STAT** under **Measurement**.

 Press the navigator button to change the mode





There are various display modes:



- *Channel overview*
The names of all the channels, the sensor type connected and the current main value are displayed.
- *Main value of the selected channel*
The name of the channel, the sensor type connected and the current main value are displayed.
- *Main value and secondary value of the selected channel*
The name of the channel, the connected sensor type and the current main value and secondary value are displayed.
Temperature sensor 1 has a special function. The states of the compressor, ventilator and heater are displayed (on/off).
- *All the measured values of all the inputs and outputs*
The current main value and secondary value as well as all the raw values are displayed.
- *User-defined measuring screens*
You configure what values you want to display. You can choose from all the measured values of physical and "virtual" sensors (calculated using mathematical functions) and output parameters.

 In the first 3 modes, you can switch between channels by turning the navigator. In addition to having an overview of all the channels, in the 4th mode you can also select a value and press the navigator to see more details for the value. You can also find your user-defined screens in this mode.



10.1.2 Device status

Icons on the display alert you to special device states.

Icon	Location	Description
F	Header bar	Diagnostic message "Failure"
M	Header bar	Diagnostic message "Maintenance request"
C	Header bar	Diagnostic message "Check"
S	Header bar	Diagnostic message "Out of specification"
	Header bar	Fieldbus or TCP/IP communication active
	Header bar	Hold active (for sensors)
	At measured value	Hold for the actuator (current output, limit switch etc.) is active
	At measured value ¹⁾	An offset has been added to the measured value
	At measured value	Measured value in "Bad" or "Alarm" state
ATC	At measured value	Automatic temperature compensation active (for sensors)
MTC	At measured value	Manual temperature compensation active (for sensors)
SIM	Header bar	Simulation mode active or Memocheck SIM connected
SIM	At measured value	The measured value is influenced by a simulated value

Icon	Location	Description
	At measured value	The displayed measured value is simulated (for sensors)
	Header bar	Controller is active

1) Only pH or ORP measurement

 If two or more diagnostic messages occur simultaneously, only the icon for the message with the highest priority is shown on the display (for the order of priority according to NAMUR, →  95).

10.1.3 Assignment views

Assignment views, e.g. **Channel assignment view**, appear as the last function in many sections of the menu. You can use this function to see which actuators or functions are connected to an input or output. The assignments appear in hierarchical order.

10.2 General settings

10.2.1 Basic settings

Some settings are visible with optional hardware only.

Menu/Setup/General settings		
Function	Options	Info
Device tag	Customized text, 32 characters	► Select any name for your controller, e.g. use the TAG name.
Temperature unit	Selection <ul style="list-style-type: none"> ▪ °C ▪ °F ▪ K Factory setting °C	
Current output range	Selection <ul style="list-style-type: none"> ▪ 0..20 mA ▪ 4..20 mA Factory setting 4..20 mA	In accordance with Namur NE43, the linear range is from 3.8 to 20.5 mA (4..20 mA) or from 0 to 20.5 mA (0..20 mA). If the range is exceeded or undershot, the current value stops at the range limit and a diagnostic message (460 or 461) is output.
Failure current	0.0 to 23.0 mA Factory setting 22.5 mA	The function meets NAMUR NE43. ► Set the current value that should be output at the current outputs in the event of an error.
 The value for Failure current should be outside the measuring range. If you decided that your Current output range = 0..20 mA you should set an error current between 20.1 and 23 mA. If the Current output range = 4..20 mA you could also define a value < 4 mA as the error current. The device allows an error current within the measuring range. In such instances pay attention to any effects this may have on your process.		

Menu/Setup/General settings		
Function	Options	Info
Alarm delay	0 to 9999 s Factory setting 0 s	The software displays only the errors that are present longer than the set delay time. This makes it possible to suppress messages that only occur briefly and are caused by normal process-specific fluctuations.
Device hold	Selection <ul style="list-style-type: none"> ▪ Disabled ▪ Enabled Factory setting Disabled	You can enable an immediate, general hold (for sensors) here. The function acts in the same way as the HOLD soft key in the screens.

10.2.2 Date and time

Menu/Setup/General settings/Date/Time		
Function	Options	Info
Set date	Depends on the format	Editing mode: Day (two-digit): 01 to 31 Month (two-digit): 01 to 12 Year (four-digit): 1970 to 2106
Set time	Depends on the format	Editing mode: hh (hour): 00 to 23 / 0 am to 12 pm mm (minutes): 00 to 59 ss (seconds): 00 to 59
▶ Extended setup		
Date format	Selection <ul style="list-style-type: none"> ▪ DD.MM.YYYY ▪ YYYY-MM-DD ▪ MM-DD-YYYY Factory setting DD.MM.YYYY	▶ Select a date format.
Time format	Selection <ul style="list-style-type: none"> ▪ hh:mm am (12h) ▪ hh:mm (24h) ▪ hh:mm:ss (24h) Factory setting hh:mm:ss (24h)	▶ Choose between 12-hour display or 24-hour display. Seconds can also be displayed with the latter version.
Time zone	Selection <ul style="list-style-type: none"> ▪ None ▪ Choice of 35 time zones Factory setting None	None = Greenwich Mean Time (London).
DST	Selection <ul style="list-style-type: none"> ▪ Off ▪ Europe ▪ USA ▪ Manual Factory setting Off	The controller adapts the summertime/normal time changeover automatically if you choose European or American daylight saving time. Manual means that you can specify the start and end of daylight saving time yourself. Here, two additional submenus are displayed in which you specify the changeover date and time.

10.2.3 Hold settings

Menu/Setup/General settings/Hold settings		
Function	Options	Info
▶Settings automatic Hold		
Hold release time	0...600 s Factory setting 0 s	The hold is maintained for the duration of the delay time when you switch to the measuring mode.
Setup menu	Selection <ul style="list-style-type: none"> ▪ Disabled ▪ Enabled Factory setting Disabled	
Diagnostics menu		Decide whether a hold should be output at the current output when the particular menu is opened.
Calibration active	Factory setting Enabled	

 If a device-specific hold is enabled, any cleaning that was previously started is stopped. You can only start a manual cleaning if a hold is active. The hold has no influence on the sampling.

10.2.4 Logbooks

Logbooks record the following events:

- Calibration/adjustment events
- Operator events
- Diagnostic events
- Programming events

You define how the logbooks should store the data.

In addition, you can also define individual data logbooks .

1. Assign the logbook name.
2. Select the measured value to be recorded.
3. Set the scan time (**Scan time**).
 - ↳ You can set the scan time individually for every data logbook.

 Further information on the logbooks: .

Menu/Setup/General settings/Logbooks		
Function	Options	Info
Logbook ident	Customized text, 16 characters	Part of the file name when exporting a logbook
Event logbook	Selection <ul style="list-style-type: none"> ▪ Off ▪ Ring buffer ▪ Fill up buffer Factory setting Ring buffer	All diagnostic messages are recorded Ring buffer If the memory is full, the most recent entry automatically overwrites the oldest entry. Fill up buffer If the memory is full, there is an overflow,i. e. you cannot store any new values. The controller displays a corresponding diagnostic message. The memory then has to be cleared manually.

Menu/Setup/General settings/Logbooks		
Function	Options	Info
Logbook program	Selection <ul style="list-style-type: none"> ▪ Off ▪ Ring buffer ▪ Fill up buffer Factory setting Ring buffer	All program cycles are recorded Ring buffer If the memory is full, the most recent entry automatically overwrites the oldest entry. Fill up buffer If the memory is 80 % full, the device displays a diagnostic message. If the memory is full, there is an overflow, i. e. no new values can be saved. The controller displays a corresponding diagnostic message. The memory then has to be cleared manually.
► Overflow warnings Event logbook = Fill up buffer		
Calibration logbook	Selection <ul style="list-style-type: none"> ▪ Off ▪ On Factory setting Off	► Decide whether you want to receive a diagnostic message if the fill buffer of the relevant logbook overflows.
Diagnostic logbook		
Configuration logbook		
► Data logbooks		
► New		You can create a maximum of 8 data logbooks.
Logbook name	Customized text, 20 characters	
Source of data	Selection <ul style="list-style-type: none"> ▪ Sensor inputs ▪ Controller ▪ Current inputs ▪ Temperature ▪ Fieldbus signals ▪ Binary inputs ▪ Mathematical functions Factory setting None	► Select a data source for the logbook entries. You can choose from the following: <ul style="list-style-type: none"> ▪ Connected sensors ▪ Available controllers ▪ Current inputs ▪ Fieldbus signals ▪ Binary input signals ▪ Mathematical functions
Measured value	Selection Depends on Source of data Factory setting None	You can record different measured values depending on the data source.
Scan time	0:00:01 to 1:00:00 Factory setting 0:01:00	Minimum time interval between two entries Format: H:MM:SS
Data logbook	Selection <ul style="list-style-type: none"> ▪ Ring buffer ▪ Fill up buffer Factory setting Ring buffer	Ring buffer If the memory is full, the most recent entry automatically overwrites the oldest entry. Fill up buffer If the memory is full, there is an overflow, i. e. no new values can be saved. The controller displays a corresponding diagnostic message. The memory then has to be cleared manually.
Overflow warnings Event logbook = Fill up buffer	Selection <ul style="list-style-type: none"> ▪ Off ▪ On Factory setting Off	► Decide whether you want to receive a diagnostic message if the fill buffer of the relevant logbook overflows.
▷ Add another logbook	Action	Only if you want to create another data logbook immediately. You add a new data logbook at a later date using New .
▷ Finished	Action	This allows you to exit the New menu.

Menu/Setup/General settings/Logbooks		
Function	Options	Info
▷ Start/stop simultaneously	Action	Appears if you have created more than one data logbook. With one mouse click, you can start or stop recording all the data logbooks.
▶ Logbook name		The name of this submenu is based on the name of the logbook and only appears once you have created a logbook.
 This menu appears several times if you have several data logbooks.		
Source of data	Read only	This is for information purposes only. If you want to record another value, delete this logbook and create a new data logbook.
Measured value		
Log time left Event logbook = Fill up buffer	Read only	Displays the days, hours and minutes remaining until the logbook is full.
Log size Event logbook = Fill up buffer	Read only	Displays the number of entries remaining until the logbook is full.
Logbook name	Customized text, 20 characters	You can change the name here again.
Scan time	0:00:01 to 1:00:00 Factory setting 0:01:00	As above Minimum time interval between two entries Format: H:MM:SS
Data logbook	Selection <ul style="list-style-type: none"> ▪ Ring buffer ▪ Fill up buffer Factory setting Ring buffer	Ring buffer If the memory is full, the most recent entry automatically overwrites the oldest entry. Fill up buffer If the memory is full, there is an overflow, i. e. no new values can be saved. The controller displays a corresponding diagnostic message. The memory then has to be cleared manually.
Overflow warnings Event logbook = Fill up buffer	Selection <ul style="list-style-type: none"> ▪ Off ▪ On Factory setting Off	▶ Decide whether you want to receive a diagnostic message if the fill buffer of the relevant logbook overflows.

Menu/Setup/General settings/Logbooks		
Function	Options	Info
▶ Line plotter		Menu to define the graphic display
Axes	Selection <ul style="list-style-type: none"> ▪ Off ▪ On Factory setting On	Should the axes (x, y) be displayed (On) or not (Off)?
Orientation	Selection <ul style="list-style-type: none"> ▪ Horizontal ▪ Vertical Factory setting Horizontal	You can choose whether the value curves should be displayed from left to right (Horizontal) or from top to bottom (Vertical). If you want to display two data logbooks simultaneously, make sure that both logbooks have the same settings here.
X-Description	Selection <ul style="list-style-type: none"> ▪ Off ▪ On Factory setting On	▶ Decide whether a description should be displayed for the axes and whether gridlines should be shown. In addition, you can also decide whether pitches should be displayed.
Y-Description		
Grids		
Pitches		
X Pitch/Grid distance	10 to 50%	▶ Determine the pitch.
Y Pitch/Grid distance	Factory setting 10 %	
▷ Remove	Action	This action removes the data logbook. Any data that have not been saved are lost.

Example: New data logbook (Setup/General settings/Logbooks/Data logbooks/New)

1. Make the settings:

- Logbook name
Assign a name. Example: "01".
- Source of data
Select a data source. Example: Sensor connected to channel 1 (CH1).
- Measured value
Select the measured value to be recorded. Example: pH value.
- Scan time
Specify the time interval between two logbook entries.
- Data logbook
Activate the logbook: specify the data storage method.

2. ../Finished: Perform the action.

- ↳ The device shows the new logbook in the list of data logbooks.

3. Select data logbook "01".

- ↳ Additional display: **Log time left**.

4. Only in the case of **Fill up buffer**:

Decide to set **Overflow warning: On or Off**.

- ↳ **On**: The device displays a diagnostic message in the event of memory overflow.

5. **Line plotter** submenu: Specify the type of graphic representation.

10.2.5 Configuring the sampling depending on the device version

The list of functions displayed depends on the device version selected with:

- Vacuum pump¹⁾
- Peristaltic pump²⁾
- Distribution drive³⁾
- Sampling assembly:⁴⁾

Menu/Setup/General settings/		
Function	Options	Info
▶ Sampling		
Number of bottles	Choice of all possible bottle combinations	The bottle configuration you ordered is preset in the device.
Bottle volume	0 to 100000 ml Factory setting Depends on the bottle configuration	If continuous operation is selected for a sampling program, there is the danger of overfilling the bottles. Do not forget to empty the bottles!
Distribution parking³⁾ (only for version with distributor drive)	Selection <ul style="list-style-type: none"> ▪ Back ▪ None Factory setting Back	Causes the distribution arm to go to the center at the back or remain parked in the current position when the device is started or the program is ended.
Distribution reference (only for version with distributor drive)	Selection <ul style="list-style-type: none"> ▪ Pre sampling ▪ Pre bottle change ▪ Pre program start Factory setting Pre sampling	The distributor arm goes through a reference point depending on the option selected.
Power failure	Selection <ul style="list-style-type: none"> ▪ Resume program ▪ Stop program Factory setting Resume program	Decide how the sampler should react when it is energized after a power failure. Resume program: <ul style="list-style-type: none"> ▪ Time and flow-paced The program calculates the omitted samples and enters them in the logbook as failed. When the program is restarted, it continues where it was interrupted. ▪ Flow-paced No samples are entered in the logbook during the power failure. When the program is restarted, it continues where it was interrupted.
Sample retries^{1), 2), 3)}	0 to 3 Factory setting 0	If sampling is started and no sample is drawn in, sampling can be repeated up to 3 times.
Sampling delay	0 to 99 s Factory setting 0 s	The start of the sampling cycle can be delayed by up to 99 s. The binary output is switched without any delay.
Liquid detection	Selection <ul style="list-style-type: none"> ▪ Automatic ▪ Semi automatic ▪ Off Factory setting Automatic	If "Semiautomatic" is selected, the purge times and intake times can be defined separately. Off: The definition of the purge times and intake times is completely time-controlled. Automatic: The last intake time determined is the new purge time. Semi automatic: If the suction heights tend to vary greatly.
Rinse cycles	0 to 3 Factory setting 0	The suction line is rinsed with the sample up to 3 times.

Menu/Setup/General settings/		
Function	Options	Info
Safety interlock(optional)	Selection Off Factory setting Off	If the peristaltic pump is opened, the safety interlock stops all the functions.
▶ Diagnostics settings		
▶ Pump tube life ²⁾		
Control	Selection ■ Off ■ On Factory setting On	Indicates the pump hose has to be exchanged.
Warning	10 to 50 h Factory setting 30 h	When the tube has been in operation for this length of time, a diagnostic message is displayed to indicate that the tube should be replaced in time.
Alarm	10 to 50 h Factory setting 30 h	
Totalizer	00-00:00 to 49710-06:28 Factory setting 00-00:00	Operating time of the current pump hose in days, hours and minutes
▷ Reset	Action	The tube life counter is reset to 0:00 h.

10.2.6 Advanced setup

Diagnostics settings

The list of diagnostic messages displayed depends on the path selected. There are device-specific messages, and messages that depend on what sensor is connected.

Menu/Setup/(General settings or Inputs<Sensor channel>)/Extended setup/Diagnostics settings/Diag. behavior		
Function	Options	Info
List of diagnostic messages		▶ Select the message to be changed. Only then can you make the settings for this message.
Diag. code	Read only	
Diagnostic message	Selection ■ On ■ Off Factory setting Depends on the message	You can deactivate or reactivate a diagnostic message here. Deactivating means: ■ No error message in the measuring mode ■ No error current at the current output
Failure current	Selection ■ On ■ Off Factory setting Depends on the message	▶ Decide whether an error current should be output at the current output if the diagnostic message display is activated.  In the event of general device errors, the error current is output at all the current outputs. In the event of channel-specific errors, the error current is only output at the assigned current output.

Menu/Setup/(General settings or Inputs<Sensor channel>)/Extended setup/Diagnostics settings/Diag. behavior		
Function	Options	Info
Status signal	<p>Selection</p> <ul style="list-style-type: none"> ▪ Maintenance (M) ▪ Out of specification (S) ▪ Function check (C) ▪ Failure (F) <p>Factory setting Depends on the message</p>	<p>The messages are divided into different error categories in accordance with NAMUR NE 107.</p> <ul style="list-style-type: none"> ▶ Decide whether you want to change a status signal assignment for your application.
Diag. output	<p>Selection</p> <ul style="list-style-type: none"> ▪ None ▪ Alarm relay ▪ Binary output ▪ Relay 1 to n (depends on the device version) <p>Factory setting None</p>	<p>You can use this function to select a binary output to which the diagnostic message should be assigned.</p> <p>For sensors with the Memosens protocol: Before being able to assign the message to an output you must first configure a relay output to Diagnostics . (Menu/Setup/Outputs: Assign the Diagnostics function and set the Operating mode to as assigned .)</p>
<p> An alarm relay is always available, regardless of the device version. Other relays are optional.</p>		
Cleaning program	<p>Selection</p> <ul style="list-style-type: none"> ▪ None ▪ Cleaning 1 ▪ Cleaning 2 ▪ Cleaning 3 ▪ Cleaning 4 <p>Factory setting None</p>	<ul style="list-style-type: none"> ▶ Decide whether the diagnostic message should trigger a cleaning program. <p>You can define the cleaning programs under: Menu/Setup/Additional functions/Cleaning.</p>
Detail information	Read only	Here you can find more information on the diagnostic message and instructions on how to resolve the problem.

Modbus

Menu/Setup/General settings/Extended setup/Modbus		
Function	Options	Info
Enable	<p>Selection</p> <ul style="list-style-type: none"> ▪ Off ▪ On <p>Factory setting On</p>	You can switch off communication at this point. The software can then only be accessed via local operation.
Termination	Read only	If the device is the last in the bus, you can terminate via the hardware.

Menu/Setup/General settings/Extended setup/Modbus		
Function	Options	Info
Settings		
Transmission Mode	Selection <ul style="list-style-type: none"> ▪ TCP ▪ RTU ▪ ASCII Factory setting (Modbus-RS485 only) RTU	The transmission mode is displayed depending on the version ordered. In the case of RS485 transmission, you can choose between RTU and ASCII . There are no choices for Modbus-TCP.
Parity <i>Modbus-RS485 only</i>	Selection <ul style="list-style-type: none"> ▪ Even (1 Stopbit) ▪ Odd (1 Stopbit) ▪ None (2 Stopbit) Factory setting Even (1 Stopbit)	
Byte order	Selection <ul style="list-style-type: none"> ▪ 1-0-3-2 ▪ 0-1-2-3 ▪ 2-3-0-1 ▪ 3-2-1-0 Factory setting 1-0-3-2	
Watchdog	0 to 999 s Factory setting 5 s	If no data transmission takes place for longer than the time set, this is an indicator that communication has been interrupted. After this time, input values received via the Modbus are considered to be invalid.

Data management

Firmware update



Please contact your local sales office for information on firmware updates available for your controller and its compatibility with earlier versions.

Current firmware version : Menu/Diagnostics/System information/.

- ▶ Back up your current setup and your logbooks to an SD card.

To install a firmware update, you must have the update available on an SD card.

1. Insert the SD card into the controller card reader.
2. Go to **Menu/Setup/General settings/Extended setup/Data management/Firmware update** .
 - ↳ The update files on the SD card are displayed.
3. Select the desired update and select yes when asked the following:
 - The current firmware will be overwritten.
 - After this the device will reboot.
 - Do you want to proceed?
 - ↳ The firmware is loaded and the device is then started with the new firmware.

Saving the setup

Saving a setup offers the following advantages, among others :

- Copying settings for other devices
- Quick and easy switching between various setups, e. g. for different user groups or for recurring sensor type changes
- Restoring a tried-and-tested setup, e. g. if you have changed a lot of settings and no longer know what the original settings were

1. Insert the SD card into the controller card reader.
2. Go to **Menu/Setup/General settings/Extended setup/Data management/Save setup** .
3. **Name:** Assign a file name.
4. Then select **Save** .
 - ↳ If you have already assigned the file name, you will be asked whether you want to overwrite the existing setup.
5. Use **OK** to confirm or cancel and assign a new file name.
 - ↳ Your setup is stored on the SD card and you can upload it quickly to the device at a later date.

Loading the setup

When you load a setup, the current configuration is overwritten.

1. Insert the SD card into the controller card reader. A setup must have been saved to the SD card.
2. Go to **Menu/Setup/General settings/Extended setup/Data management/Load setup** .
 - ↳ A list of all the setups on the SD card is displayed.
An error message is displayed if there is no valid setup on the card.
3. Select the desired setup.
 - ↳ A warning is displayed:

The current parameters will be overwritten and the device will reboot.
Warning: Please note that cleaning and controller programs can be active.
Do you want to proceed?
4. Use **OK** to confirm or cancel.
 - ↳ If you select **OK** to confirm, the device restarts with the desired setup.

Exporting the setup

Exporting a setup offers the following advantages, among others:

- Export in XML format with a stylesheet for formatted display in an XML-compatible application, such as . Microsoft Internet Explorer
- Importing the data (drag and drop the XML file into a browser window)

1. Insert the SD card into the controller card reader.
2. Go to **Menu/Setup/General settings/Extended setup/Data management/Export setup** .
3. **Name:** Assign a file name.
4. Then select **Export** .
 - ↳ If you have already assigned the file name, you will be asked whether you want to overwrite the existing setup.
5. Use **OK** to confirm or cancel and assign a new file name.
 - ↳ Your setup is saved on the SD card in the "Device" folder.

 You cannot upload the exported setup to the device again. You must use the **Save setup** . This is the only way you can save a setup to an SD card and reload it later on or upload it to other devices.

Activation code

You require activation codes for:

- Additional functions
- Firmware upgrades

i If your original device has activation codes, these can be found on . The corresponding device functions are activated at the factory. You only require the codes if servicing the device or deactivating fieldbus protocols.

1. Enter activation code: **Menu/Setup/General settings/Extended setup/Data management/Activation code.**
2. Confirm your entry.
 - ↳ The new hardware or software function is activated and can be configured.

Functions that are enabled by an activation code:

Function	Activation code beginning with
Two current outputs (BASE2-E module only)	081...
Web server ¹⁾	351...
HART	0B1...
PROFIBUS DP	0B3...
Modbus TCP	0B8...
Modbus RS485	0B5...
EtherNet/IP	0B9...
PROFINET	0B7...
Feedforward control	220...
Chemoclean Plus	25...
Configure the mathematical function Cation exchanger capacity	301...

1) Via Ethernet socket of the Base2 module, for versions without an Ethernet fieldbus

10.3 Programming

The following box provides an overview of the differences between the Basic, Standard and Advanced program types.

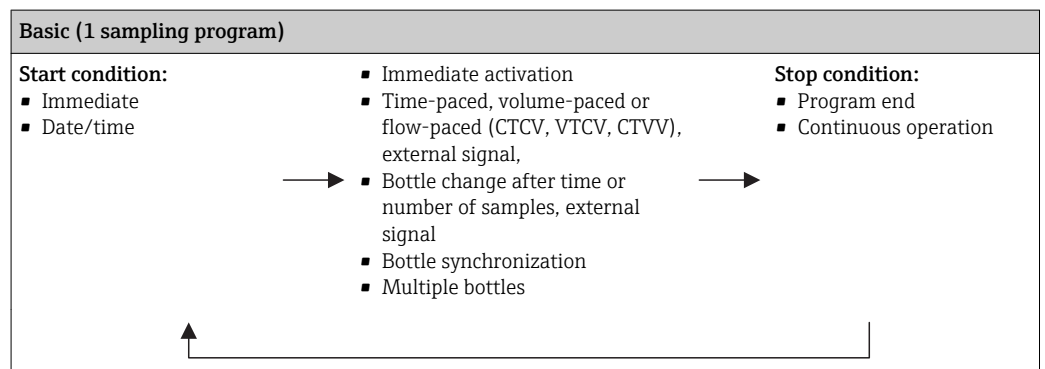

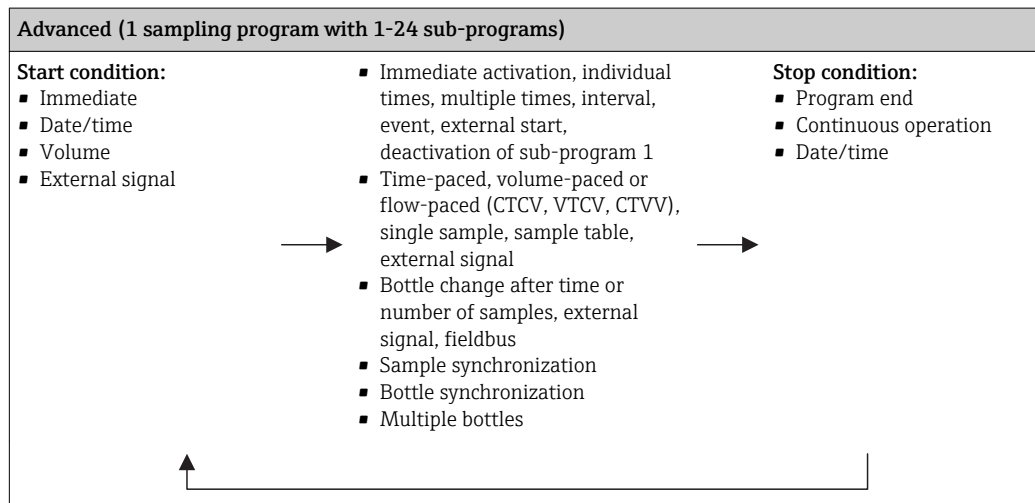
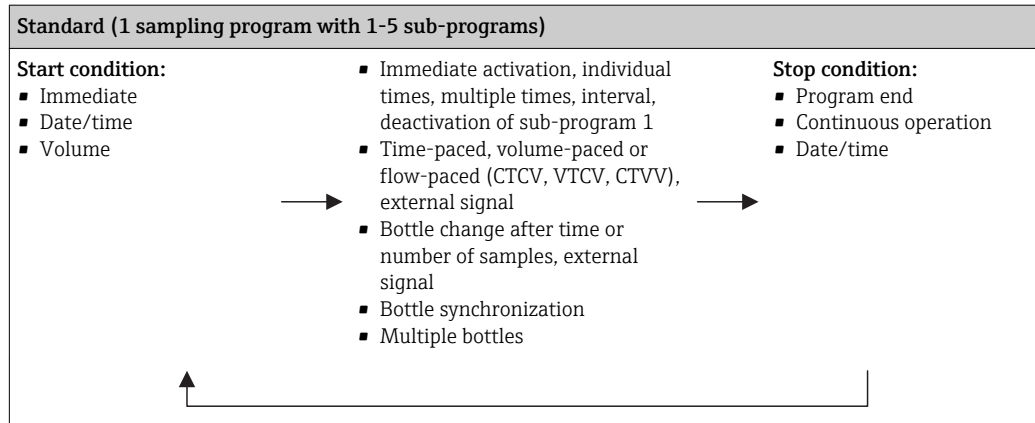

10.3.1 Overview of the possible program types

Basic program type	Standard program type	Advanced program type
Time-paced	Time-paced	Time-paced
Flow-paced	Flow-paced	Flow-paced
		Single sample
		Sampling table
		External signal
		Fieldbus (optional)
Flow proportional sampling/time override (CTVV)	Flow proportional sampling/time override (CTVV)	Flow proportional sampling/time override (CTVV)

The graphic below explains the various ways sampling can be controlled on the basis of a flow curve:

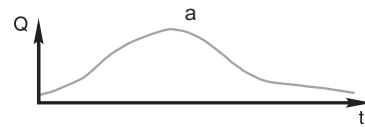

a. Flow curve

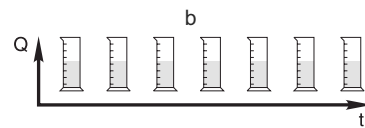

b. **Time-proportional sampling (CTCV)**

A constant sample volume (e.g. 50 ml) is taken at regular intervals (e.g. every 5 min).

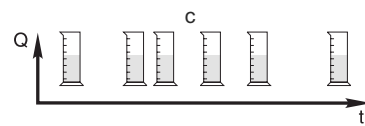

c. **Volume-proportional sampling (VTCV)**

A constant sample volume is taken at variable intervals (depending on the inflow volume).

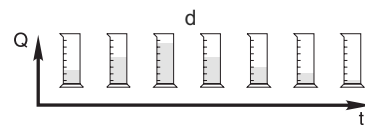

d. **Flow-proportional sampling (CTVV)**

A variable sample volume (the sample volume depends on the flow rate) is taken at regular intervals (e.g. every 10 min).

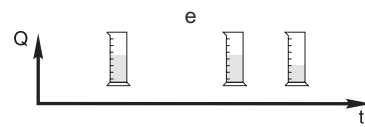

e. **Event-controlled sampling**

Sampling is triggered by an event (e.g. pH limit value). Sampling can be time-paced, volume-paced or flow-paced, or single samples can be taken.

A0014045

13 Sampling control

Q Flow

t Time

The following table explains the various types of sampling using specific examples.

Type of sampling	Example	Info
Time-paced	<ul style="list-style-type: none"> ▪ Sampling interval: 5 min ▪ Sampling volume: 50 ml ▪ Bottle change mode: 2 h <p>With this setting, a 50 ml sample is taken every 5 minutes. 12 samples are thus taken every hour. Each bottle is filled over a period of 2 hours. This results in a total sampling volume of 24 samples per bottle x 50 ml = 1200 ml.</p>	<p>This type of sampling remains constant over time and does not take changes in flow or polluting load into account. It is possible to take a representative sample if the intervals are brief (e.g. 5 min).</p>
Flow-paced	<p>Controlled via current input</p> <ul style="list-style-type: none"> ▪ Signal: 0 to 20 mA = 0 to 600 m³/h ▪ Sampling interval: 5 min ▪ Sampling volume: 50 ml ▪ Bottle change mode: 2 h <p>If 20 mA = 600 m³/h, a sample is taken every two minutes (smallest sampling interval with maximum flow rate). The total number of samples amounts to 60 samples per bottle. With a flow rate of 300 m³/h, a sample is taken every four minutes.</p> <p>Controlled via binary input</p> <ul style="list-style-type: none"> ▪ Signal pulse: 5 m ▪ Sampling interval: 5 min ▪ Sampling volume: 50 ml ▪ Bottle change mode: 2 h <p>The pulses are scaled at the flowmeter. By multiplying the pulses at the sampling interval, the shortest sampling interval at the maximum pulse frequency can be set. Example: With a maximum flow rate of 600 m³/h, the pulse frequency at 5 m³ is 120 pulses/h or 2 pulses/min. With a sampling interval of 20 m³, a sample is taken after 4 pulses = 2 minutes.</p>	<ul style="list-style-type: none"> ▪ The current inputs can be configured for the current range of 0 to 20 mA or 4 to 20 mA. ▪ The binary inputs require power (24 V DC) for floating contacts. <p>In the case of flow-paced sampling, the sampling interval is calculated on the basis of the volume flow. The same sampling volume is taken at variable intervals.</p> <p>Advantage: Good, representative results in the event of minor fluctuations in flow.</p> <p>Disadvantage: Longer intervals when the level of water is low mean that malfunctions cannot be detected.</p>

Type of sampling	Example	Info
Time/flow-paced (only possible with peristaltic pump) Time/flow-paced	<p>Controlled via current input</p> <ul style="list-style-type: none"> ▪ Signal: 0 to 20 mA ▪ Sampling interval: 10 min ▪ Sampling volume: variable <p>The maximum sampling volume is defined at the maximum flow rate. Example: The maximum flow rate at 20 mA at the current input is 160 l/s, and the maximum sampling volume is 200 ml. When transferring samples into a 30l mixed sample container, 144 samples are taken per day with a maximum sampling volume of 28.8 l. With a flow rate of 80 l/s, a sampling volume of only 100 ml would be grabbed, and a sampling volume of 50 ml would be grabbed at a flow rate of 40 l/s. The sampling volume is always calculated based on the flow.</p> <p>Controlled via binary input</p> <ul style="list-style-type: none"> ▪ Binary input (pulse per flow unit) ▪ Sampling interval: 10 min ▪ Sampling volume: variable <p>The sampling volume is defined for a flow pulse, e.g.: 1 pulse is 20 ml. For instance, if 5 flow pulses are counted between the sampling intervals, this results in a sampling volume of $5 \times 20 = 100$ ml, and a volume of $8 \times 20 = 160$ ml for 8 pulses. If a binary input is used for time/flow-paced sampling, the sampling volume is calculated per sample as a percentage of the specified sampling volume.</p>	<p>Samples are taken at set intervals with a variable sampling volume. The sampling volume is calculated from the flow rate. More volume is grabbed when the flow is high than when it is low. Since the flow normally fluctuates and the maximum flow is only rarely a constant variable, the sampling volume transferred to the container will depend on the daily average.</p> <p>Advantage: Very good, representative sampling given large fluctuations in the flow and constant time intervals.</p> <p>Disadvantage: Too little sampling volume is made available for analysis when the flow is low.</p> <p>Advantage with current input: For the sampling interval, either the current flow rate or the average value between the last and current flow rate is used to calculate the exact sampling volume (depending on the presetting).</p> <p>Disadvantage with binary input: For the sampling interval, the pulses counted since the last sampling are multiplied by a volume. If this is too high - e.g. 100 ml - the composition of the sample is not representative for analysis.</p>
Event	<p>Event-based sampling is controlled via the current input, binary input and/or sensor input. The subprogram created waits to be activated by an event that can consist of up to 3 individual events. Every possible condition can be created using logical "and" / "or" links. For example, the information from a flowmeter connected to the current input can be linked to a rain gage and a pH sensor signal connected to the binary input. An event is defined as limit value violation (exceeded or undershot), range monitoring within or outside a range, or a rate of change. Users can decide whether additional sampling is started when the event starts and/or ends. For the duration of the event, users can choose from time-paced, flow-paced or time/flow-paced sampling, or can take single samples, use a sampling table or the external control system.</p>	<p>The sampler waits for an event. This event takes place via internal sensor signal processing or via devices connected externally. As bottle assignment is possible when using several bottles, events can be assigned to individual bottles. A maximum of 24 subprograms can be started simultaneously and assigned to individual bottles.</p>

Bottle synchronization

The bottle synchronization setting is possible with all types of program. In addition, bottle synchronization can be switched via an external signal. Bottle synchronization is only possible with a bottle change after a specific time and not with a bottle change after a number of samples.

Specific bottles can be assigned specific filling times with the bottle synchronization function. For example, bottle 1 is to be filled from midnight to 2 a.m., bottle 2 from 2 a.m. to 4 a.m. etc.. The following options are available for this:

■ **None:**

The sampling and bottle change times are not synchronized.

■ **1. bottle change time:**

Sampling starts with the first bottle. The change to the next bottle is synchronized. For example, a time of 2 hours was set for bottle changeover, and 00:00 was set for the synchronization. If the program is started at 5:23 a.m., for example, bottle 1 is initially filled. The system switches for the first time to bottle 2 at midnight (00:00), to bottle 3 at 2 a.m. etc.

■ **Time of change + bottle number:** A specific filling time is assigned to every bottle.

E.g.: 00:00 to 02:00: bottle 1;
02:00 to 04:00: bottle 2;
04:00 to 06:00: bottle 3, etc.

If the program is started at 10:00, for example, the device starts by filling bottle 6. It is also possible to start synchronization on a specific day of the week. For example, a time of 24 hours was set for bottle changeover, Monday 00:00 was the time set for synchronization, and Tuesday 8 a.m. was set for starting the program. The system fills bottle 2 until 00:00 on Wednesday and then switches to bottle 3.

■ **External signal:**

The system changes to the next bottle when an external signal is received. The external signal first has to be configured via the binary input. The binary input can then be selected as the source.

 In the Standard and Advanced program, the bottle position is not currently restored following a power failure.

10.3.2 Program type: Basic

With the Basic program type, you can create simple sampling programs quickly based on time, volume and flow.

In the case of volume- and flow-controlled sampling, the inputs must be configured appropriately beforehand. If you want to create a program and use it immediately, you must check the configuration of the sampler before programming.

The dosing volume setting makes it possible to correctly calculate the level in the bottle and is a reliable way of preventing the bottles from being overfilled.

Here you can adjust the bottle configuration, the bottle volume and, in the case of the device version with vacuum pump, the correct dosing volume:

► **Menu /Setup/General settings/Sampling**

 You can go to **Setup program** either via the overview under **Select sampling program** or via the path **Menu/Setup/Sampling programs**

Menu/Setup/Sampling programs		
Function	Options	Info
Current program:	Read only	The last sampling program to be created or used is displayed.
Status	Read only	User interface Active : The sampling program has been started and the device takes a sample as per the set parameters. User interface Inactive : No sampling program has been started, or a program that was running has been paused. User interface Pause : Sampling program paused.

Menu/Setup/Sampling programs		
Function	Options	Info
▶ Setup program		
New		A list of all the programs created is displayed. For this reason, it is often helpful to add a 'B' for Basic in the program name.
<p>Program1, which is supplied with the device, is displayed, as is a list of all the programs already created (Basic, Standard or Advanced programs). You can either create a new program or select an existing one. If you select an existing program, you can edit, delete, start or duplicate it. Furthermore, you can also see whether this program is a Basic, Standard or Advanced program. If you are creating a new program, select the Basic, Standard or Advanced program type.</p>		
▶ Basic		
Program name	Free text	Use a distinct name for your sampling program. The program name can be up to 16 characters long.
Bottle configuration	Choice of all possible bottle combinations Options: <ul style="list-style-type: none"> ▪ 1 x PE direct distribution ▪ 12 x PE direct distribution ▪ 24 x PE direct distribution ▪ 12 x + 6 x PE direct distribution 	The ordered bottle configuration is preset or the configuration selected in the setup is displayed.
Bottle volume	0 to 100000 ml Factory setting <ul style="list-style-type: none"> ▪ 30000 ml ▪ 20000 ml 	Set the bottle volume. The preset value depends on the bottle configuration configured. The bottle volume is always 30 l for individual containers. The preset value depends on the bottle configuration. The bottle volume is always 20 l for individual containers. In the case of asymmetric distribution, e.g. 6 x 3 l + 2 x 13 l or 12 x 1 l + 6 x 2 l, you can set the bottle volume on the left and right in the menu items that follow.
Sampling mode	Selection <ul style="list-style-type: none"> ▪ Time paced CTCV ▪ Flow paced VTCV ▪ Time/flow paced CTVV ▪ External signal Factory setting Time paced CTCV	The following functions depend on the option selected. These versions are illustrated individually in the following section to provide a clearer understanding of the options. Time paced CTCV A constant sampling volume is taken at steady intervals. In "Advanced" only: Time monitoring (min: 00:01:00; max: 99:59:00) Flow paced VTCV A constant sampling volume is taken at variable intervals. Time/flow paced CTVV A sampling volume adjusted to the flow rate is taken at steady intervals. The sampling volume is calculated based on the current flow rate or the average value between two samples. External signal Controlled via binary input.

Settings with a time-paced Basic program

Settings with the Basic program type with 1 bottle

Sampling mode = Time paced CTCV

Menu/Setup/Sampling programs/Setup program/New/Basic		
Function	Options	Info
Sampling interval	00:01:00 ... 99:59:00 HH:MM:SS Factory setting 00:10:00 HH:MM:SS 00:10:00 HH:MM:SS HH:MM:SS Factory setting 00:10:00 HH:MM:SS	Set the sampling interval.
Dosing volume Sampling volume Sampling volume	Factory setting Vacuum pump: 200 ml Peristaltic pump: 100 ml Sampling assembly: 200 ml	Set the dosing volume or the sampling volume. Set the sampling volume. In the version with a vacuum pump or sampling assembly, the volume is taken from the setup and can only be modified there. The volume accuracy and the repeatability of a sampling volume < 20 ml may vary with the peristaltic pump depending on the specific application.
Sampling volume	10 to 10000 ml Factory setting 100 ml	Set the sampling volume. The dosing accuracy and the repeatability of a sample volume < 20 ml can vary, depending on the specific application.
Bottle change mode	Selection <ul style="list-style-type: none"> ■ Number of samples ■ Time ■ External signal Factory setting External signal	The bottle can be changed after a specific number of samples, after a time or by an external signal.
If is selected: Bottle change mode Number of samples:		
Samples per bottle	1 ... 9999 Factory setting 1	Set the number of samples. If the bottle is full beforehand based on the calculated level, the system prevents more samples being added to the bottle. Such samples are logged as failed samples in the program logbook. At the same time, the diagnostics message "Overfill check" (F353) is also triggered. Set the number of samples.
Having selected Bottle change mode Time:		
Time interval	00-00:02 ... 31-00:00 DD-HH:MM Factory setting 00-01:00 DD-HH:MM	Set the time (days, hours and minutes) after which the system should change to the next bottle.
Bottle synchronization	Selection <ul style="list-style-type: none"> ■ None ■ 1. bottle change time ■ 1. Time of change + bottle number Factory setting None	None The sampling and bottle change times are not synchronized. 1. bottle change time Sampling starts with the first bottle. Set the synchronization time. 1. Time of change + bottle number Each bottle is assigned to a specific fill time. Set the synchronization time and the weekday.

Menu/Setup/Sampling programs/Setup program/New/Basic		
Function	Options	Info
Having selected Bottle change mode Bottle change external signal :		
External event	Selection <ul style="list-style-type: none"> ▪ No bottle change input configured ▪ Binary input Sx Factory setting No bottle change input configured	A binary input must be configured for this function. The sampling input can be configured under "Inputs".
Multiple bottles	0 ... 23 The configuration options depend on the current number of bottles Factory setting 0	Multiple bottles: "Simultaneous" transfer of two samples to separate bottles.
Start condition	Selection <ul style="list-style-type: none"> ▪ Immediate ▪ Date/time Factory setting Immediate	The sampling program can be started either immediately or at a specific, configurable time.
Having selected Start condition Immediate :		
Sample at start	Selection <ul style="list-style-type: none"> ▪ Yes ▪ No Factory setting Yes	Yes The first sample is taken when the program is started. No The system waits for the interval to elapse before the first sample is taken.
Having selected Start condition Date/time :		
Start date	01.01.2000 ... 31.12.2099 Factory setting DD.MM.YYYY	Set the start date for the sampling program. The format depends on the option configured under general settings.
Start time	00:00:00 ... 23:59:59 Factory setting HH:MM:SS (24h)	Set the time when the sampling program is started. The format depends on the option configured under general settings.
Stop condition	Selection <ul style="list-style-type: none"> ▪ Program end ▪ Continuous Factory setting Program end	Program end The device stops sampling automatically once it has run through the set program. Continuous The device runs through the set program continuously in an infinite loop. Do not forget to empty the bottles.
Assignment bin. output	Selection <ul style="list-style-type: none"> ▪ No binary output configured ▪ Binary output Sx Factory setting No binary output configured	Assignment of the binary output to the program cycle.
► Inputs		Settings for the inputs can be made as described in the "Inputs" section.

Settings with the Basic program type with multiple bottles

Sampling mode = Time paced CTCV

Menu/Setup/Sampling programs/Setup program/New/Basic		
Function	Options	Info
Sampling interval	00:01:00 ... 99:59:00 HH:MM:SS Factory setting 00:10:00 HH:MM:SS 00:10:00 HH:MM:SS HH:MM:SS Factory setting 00:10:00 HH:MM:SS	Set the sampling interval.
Sampling volume	10 to 10000 ml Factory setting 100 ml	Set the sampling volume. The dosing accuracy and the repeatability of a sample volume < 20 ml can vary, depending on the specific application.
Bottle change mode	Selection <ul style="list-style-type: none"> ■ Number of samples ■ Time ■ External signal Factory setting External signal	The bottle can be changed after a specific number of samples, after a time or by an external signal.
If is selected: Bottle change mode Number of samples		
Samples per bottle	1 ... 9999 Factory setting 1	Set the number of samples. If the bottle is full beforehand based on the calculated level, the system prevents more samples being added to the bottle. Such samples are logged as failed samples in the program logbook. At the same time, the diagnostics message "Overfill check" (F353) is also triggered. Set the number of samples.
Having selected Bottle change mode Time		
External event	Selection <ul style="list-style-type: none"> ■ No bottle change input configured ■ Binary input Sx Factory setting No bottle change input configured	A binary input must be configured for this function. The sampling input can be configured under "Inputs".
Time interval	00-00:02 ... 31-00:00 DD-HH:MM Factory setting 00-01:00 DD-HH:MM	Set the time (days, hours and minutes) after which the system should change to the next bottle.
Multiple bottles	0 ... 23 The configuration options depend on the current number of bottles Factory setting 0	Multiple bottles "Simultaneous" transfer of two samples to separate bottles.

Menu/Setup/Sampling programs/Setup program/New/Basic		
Function	Options	Info
Bottle synchronization	Selection <ul style="list-style-type: none"> ▪ None ▪ 1. bottle change time ▪ 1. Time of change + bottle number Factory setting None	None The sampling and bottle change times are not synchronized. 1. bottle change time Sampling starts with the first bottle. Set the synchronization time. 1. Time of change + bottle number Each bottle is assigned to a specific fill time. Set the synchronization time and the weekday.
Having selected Bottle change mode External signal		
Bottle chg. sig. input	Selection <ul style="list-style-type: none"> ▪ No bottle change input configured ▪ Binary input Sx Factory setting No bottle change input configured	A binary input must be configured for this function. The sampling input can be configured under "Inputs".
Multiple bottles	0 ... 23 The configuration options depend on the current number of bottles Factory setting 0	Multiple bottles "Simultaneous" transfer of two samples to separate bottles.
Start condition	Selection <ul style="list-style-type: none"> ▪ Immediate ▪ Date/time Factory setting Immediate	The sampling program can be started either immediately or at a specific, configurable time.
Having selected Start condition Immediate		
Sample at start	Selection <ul style="list-style-type: none"> ▪ Yes ▪ No Factory setting Yes	Yes The first sample is taken when the program is started. No The system waits for the interval to elapse before the first sample is taken.
Start date	01.01.2000 ... 31.12.2099 Factory setting DD.MM.YYYY	Set the start date for the sampling program. The format depends on the option configured under general settings.
Start time	00:00:00 ... 23:59:59 Factory setting HH:MM:SS (24h)	Set the time when the sampling program is started. The format depends on the option configured under general settings.
Stop condition	Selection <ul style="list-style-type: none"> ▪ Program end ▪ Continuous Factory setting Program end	Program end The device stops sampling automatically once it has run through the set program. Continuous The device runs through the set program continuously in an infinite loop. Do not forget to empty the bottles.

Menu/Setup/Sampling programs/Setup program/New/Basic		
Function	Options	Info
Assignment bin. output	Selection <ul style="list-style-type: none"> ■ No binary output configured ■ Binary output Sx Factory setting No binary output configured	Assignment of the binary output to the program cycle.
► Inputs		Settings for the inputs can be made as described in the "Inputs" section.

Settings with a flow-paced Basic program

Settings with the Basic program type with 1 bottle

Sampling mode = Flow paced VTCV

Menu/Setup/Sampling programs/Setup program/New/Basic		
Function	Options	Info
Flowmeter input	Selection <ul style="list-style-type: none"> ■ No flow input configured ■ Binary input S:x ■ Current input S:x Factory setting No flow input configured	Select the flow input. The binary input or the current input must be configured for this function. Only the inputs configured as a flow input are displayed.
Sampling interval (for version with vacuum pump or peristaltic pump) Sampling interval	1000 to 9,999,000 m ³ 3 Factory setting 10,000 m ³ 3	Set the sampling interval. The unit and the number of decimal places are displayed as configured under Setup/ Inputs .
Sampling volume	10 to 10000 ml Factory setting 100 m	Set the sampling volume. The dosing accuracy and the repeatability of a sample volume < 20 ml can vary, depending on the specific application.
Bottle change mode	Selection <ul style="list-style-type: none"> ■ Number of samples ■ Time ■ External signal Factory setting External signal	The bottle can be changed after a specific number of samples, after a time or by an external signal.
If is selected: Bottle change mode Number of samples		
Samples per bottle	1 ... 9999 Factory setting 1	Set the number of samples.
Having selected Bottle change mode Time		
Time interval	00-00:02 ... 31-00:00 DD-HH:MM Factory setting 00-01:00 DD-HH:MM	Set the time (days, hours and minutes) after which the system should change to the next bottle.

Menu/Setup/Sampling programs/Setup program/New/Basic		
Function	Options	Info
Bottle synchronization	Selection <ul style="list-style-type: none"> ▪ None ▪ 1. bottle change time ▪ 1. Time of change + bottle number Factory setting None	None The sampling and bottle change times are not synchronized. 1. bottle change time Sampling starts with the first bottle. Set the synchronization time. 1. Time of change + bottle number Each bottle is assigned to a specific fill time. Set the synchronization time and the weekday.
Start condition	Selection <ul style="list-style-type: none"> ▪ Immediate ▪ Date/time Factory setting Immediate	The sampling program can be started either immediately or at a specific, configurable time.
Having selected Start condition Immediate		
Sample at start	Selection <ul style="list-style-type: none"> ▪ Yes ▪ No Factory setting Yes	Yes The first sample is taken when the program is started. No The system waits for the interval to elapse before the first sample is taken.
Having selected Start condition Date/time		
Start date	01.01.2000 ... 31.12.2099 Factory setting DD.MM.YYYY	Set the start date for the sampling program. The format depends on the option configured under general settings.
Start time	00:00:00 ... 23:59:59 Factory setting HH:MM:SS (24h)	Set the time when the sampling program is started. The format depends on the option configured under general settings.
Stop condition	Selection <ul style="list-style-type: none"> ▪ Program end ▪ Continuous Factory setting Program end	Program end The device stops sampling automatically once it has run through the set program. Continuous The device runs through the set program continuously in an infinite loop. Do not forget to empty the bottles.
Assignment bin. output	Selection <ul style="list-style-type: none"> ▪ No binary output configured ▪ Binary output Sx Factory setting No binary output configured	Assignment of the binary output to the program cycle.
► Inputs		Settings for the inputs can be made as described in the "Inputs" section.

Settings with the Basic program type with multiple bottles

Sampling mode = Flow paced VTCV

Menu/Setup/Sampling programs/Setup program/New/Basic		
Function	Options	Info
Flowmeter input	Selection <ul style="list-style-type: none"> ■ No flow input configured ■ Binary input S:x ■ Current input S:x Factory setting No flow input configured	Select the flow input. The binary input or the current input must be configured for this function. Only the inputs configured as a flow input are displayed.
Sampling interval (for version with vacuum pump or peristaltic pump) Sampling interval	1000 to 9,999,000 m ³ Factory setting 10,000 m ³	Set the sampling interval. The unit and the number of decimal places are displayed as configured under Setup/ Inputs .
Sampling volume	10 to 10000 ml Factory setting 100 ml	Set the sampling volume. The dosing accuracy and the repeatability of a sample volume < 20 ml can vary, depending on the specific application.
Bottle change mode	Selection <ul style="list-style-type: none"> ■ Number of samples ■ Time ■ External signal Factory setting External signal	The bottle can be changed after a specific number of samples, after a time or by an external signal.
If is selected: Bottle change mode Number of samples		
Samples per bottle	1 ... 9999 Factory setting 1	Set the number of samples.
Having selected Bottle change mode Time		
Time interval	00-00:02 ... 31-00:00 DD-HH:MM Factory setting 00-01:00 DD-HH:MM	Set the time (days, hours and minutes) after which the system should change to the next bottle.
Multiple bottles	0 ... 23 The configuration options depend on the current number of bottles Factory setting 0	Multiple bottles "Simultaneous" transfer of two samples to separate bottles.
Bottle synchronization	Selection <ul style="list-style-type: none"> ■ None ■ 1. bottle change time ■ 1. Time of change + bottle number Factory setting None	None The sampling and bottle change times are not synchronized. 1. bottle change time Sampling starts with the first bottle. Set the synchronization time. 1. Time of change + bottle number Each bottle is assigned to a specific fill time. Set the synchronization time and the weekday.
Having selected Bottle change mode External signal		

Menu/Setup/Sampling programs/Setup program/New/Basic		
Function	Options	Info
Bottle chg. sig. input	Selection <ul style="list-style-type: none"> ▪ No bottle change input configured ▪ Binary input Sx Factory setting No bottle change input configured	The bottle change input can be configured under ► Inputs . A binary input must be configured for this function. The sampling input can be configured under "Inputs".
Multiple bottles	0 ... 23 The configuration options depend on the current number of bottles Factory setting 0	Multiple bottles "Simultaneous" transfer of two samples to separate bottles.
Start condition	Selection <ul style="list-style-type: none"> ▪ Immediate ▪ Date/time Factory setting Immediate	The sampling program can be started either immediately or at a specific, configurable time.
Having selected Start condition Immediate		
Sample at start	Selection <ul style="list-style-type: none"> ▪ Yes ▪ No Factory setting Yes	Yes The first sample is taken when the program is started. No The system waits for the interval to elapse before the first sample is taken.
Having selected Start condition Date/time		
Start date	01.01.2000 ... 31.12.2099 Factory setting DD.MM.YYYY	Set the start date for the sampling program. The format depends on the option configured under general settings.
Start time	00:00:00 ... 23:59:59 Factory setting HH:MM:SS (24h)	Set the time when the sampling program is started. The format depends on the option configured under general settings.
Stop condition	Selection <ul style="list-style-type: none"> ▪ Program end ▪ Continuous Factory setting Program end	Program end The device stops sampling automatically once it has run through the set program. Continuous The device runs through the set program continuously in an infinite loop. Do not forget to empty the bottles.
Assignment bin. output	Selection <ul style="list-style-type: none"> ▪ No binary output configured ▪ Binary output Sx Factory setting No binary output configured	Assignment of the binary output to the program cycle.
► Inputs		Settings for the inputs can be made as described in the "Inputs" section.

Settings for the time/flow-paced Basic program (only for version with peristaltic pump)

Settings with the Basic program type with 1 bottle

Sampling mode = Time/flow paced CTVV

Menu/Setup/Sampling programs/Setup program/New/Basic		
Function	Options	Info
Sampling volume input	Selection <ul style="list-style-type: none"> ■ No flow input configured ■ Binary input S:x ■ Current input S:x Factory setting No flow input configured	Select the sampling volume input. The binary input or the current input must be configured for this function. Only the inputs configured as a sampling volume input are displayed.
Sampling interval	00:01:00 ... 99:59:00 HH:MM:SS Factory setting 00:10:00 HH:MM:SS 00:10:00 HH:MM:SS HH:MM:SS Factory setting 00:10:00 HH:MM:SS	Set the sampling interval.
If is selected: Sampling volume input Binary input		
Sampling volume	10 to 10000 ml Factory setting 20 ml	Set the sampling volume. The dosing accuracy and the repeatability of a sample volume < 20 ml can vary, depending on the specific application.
If is selected: Sampling volume input Current input		
Sampling volume 20mA	10 to 10000 ml Factory setting 100 ml	Set what sampling volume should be grabbed at 20 mA. The dosing accuracy and the repeatability of a sample volume < 20 ml can vary, depending on the specific application.
Flow calculation	Selection <ul style="list-style-type: none"> ■ Current ■ Average flow Factory setting Current	Current: The current flow is converted to the sampling volume at the time of sampling. Average flow: The system calculates the mean between the last and the current sample and sets the sampling volume accordingly.
Bottle change mode	Selection <ul style="list-style-type: none"> ■ Number of samples ■ Time ■ External signal Factory setting External signal	The bottle can be changed after a specific number of samples, after a time or by an external signal.
Having selected Bottle change mode Number of samples		
Samples per bottle	1 ... 9999 Factory setting 1	Set the number of samples.
Having selected Bottle change mode Time		
Time interval	00-00:02 ... 31-00:00 DD-HH:MM Factory setting 00-01:00 DD-HH:MM	Set the time (days, hours and minutes) after which the system should change to the next bottle.

Menu/Setup/Sampling programs/Setup program/New/Basic		
Function	Options	Info
Bottle synchronization	Selection <ul style="list-style-type: none"> ▪ None ▪ 1. bottle change time ▪ 1. Time of change + bottle number Factory setting None	None The sampling and bottle change times are not synchronized. 1. bottle change time Sampling starts with the first bottle. Set the synchronization time. 1. Time of change + bottle number Each bottle is assigned to a specific fill time. Set the synchronization time and the weekday.
Start condition	Selection <ul style="list-style-type: none"> ▪ Immediate ▪ Date/time Factory setting Immediate	The sampling program can be started either immediately or at a specific, configurable time.
Having selected Start condition Date/time		
Start date	01.01.2000 ... 31.12.2099 Factory setting DD.MM.YYYY	Set the start date for the sampling program. The format depends on the option configured under general settings.
Start time	00:00:00 ... 23:59:59 Factory setting HH:MM:SS (24h)	Set the time when the sampling program is started. The format depends on the option configured under general settings.
Stop condition	Selection <ul style="list-style-type: none"> ▪ Program end ▪ Continuous Factory setting Program end	Program end The device stops sampling automatically once it has run through the set program. Continuous The device runs through the set program continuously in an infinite loop. Do not forget to empty the bottles.
Assignment bin. output	Selection <ul style="list-style-type: none"> ▪ No binary output configured ▪ Binary output Sx Factory setting No binary output configured	Assignment of the binary output to the program cycle.
► Inputs		Settings for the inputs can be made as described in the "Inputs" section.

Settings with the Basic program type with multiple bottles

Sampling mode = Time/flow paced CTVV

Menu/Setup/Sampling programs/Setup program/New/Basic		
Function	Options	Info
Sampling volume input	Selection <ul style="list-style-type: none"> ■ No flow input configured ■ Binary input S:x ■ Current input S:x Factory setting No flow input configured	Select the sampling volume input. The binary input or the current input must be configured for this function. Only the inputs configured as a sampling volume input are displayed.
Sampling interval	00:01:00 ... 99:59:00 HH:MM:SS Factory setting 00:10:00 HH:MM:SS 00:10:00 HH:MM:SS HH:MM:SS Factory setting 00:10:00 HH:MM:SS	Set the sampling interval.
If is selected: Sampling volume input Binary input		
Sampling volume	10 to 10000 ml Factory setting 20 ml	Set the sampling volume. The dosing accuracy and the repeatability of a sample volume < 20 ml can vary, depending on the specific application.
If is selected: Sampling volume input Current input		
Sampling volume 20mA	10 to 10000 ml Factory setting 100 ml	Set what sampling volume should be grabbed at 20 mA. The dosing accuracy and the repeatability of a sample volume < 20 ml can vary, depending on the specific application.
Flow calculation	Selection <ul style="list-style-type: none"> ■ Current ■ Average flow Factory setting Current	Current: The current flow is converted to the sampling volume at the time of sampling. Average flow: The system calculates the mean between the last and the current sample and sets the sampling volume accordingly.
Bottle change mode	Selection <ul style="list-style-type: none"> ■ Number of samples ■ Time ■ External signal Factory setting External signal	The bottle can be changed after a specific number of samples, after a time or by an external signal.
Having selected Bottle change mode Number of samples		
Samples per bottle	1 ... 9999 Factory setting 1	Set the number of samples.
Having selected Bottle change mode Time		
Time interval	00-00:02 ... 31-00:00 DD-HH:MM Factory setting 00-01:00 DD-HH:MM	Set the time (days, hours and minutes) after which the system should change to the next bottle.

Menu/Setup/Sampling programs/Setup program/New/Basic		
Function	Options	Info
Multiple bottles	0 ... 23 The configuration options depend on the current number of bottles Factory setting 0	Multiple bottles: "Simultaneous" transfer of two samples to separate bottles.
Having selected Bottle change mode External signal		
Bottle chg. sig. input	Selection <ul style="list-style-type: none"> ▪ No bottle change input configured ▪ Binary input Sx Factory setting No bottle change input configured	The bottle change input can be configured under ► Inputs . A binary input must be configured for this function. The sampling input can be configured under "Inputs".
Multiple bottles	0 ... 23 The configuration options depend on the current number of bottles Factory setting 0	Multiple bottles: "Simultaneous" transfer of two samples to separate bottles.
Start condition	Selection <ul style="list-style-type: none"> ▪ Immediate ▪ Date/time Factory setting Immediate	The sampling program can be started either immediately or at a specific, configurable time.
Having selected Start condition Date/time		
Start date	01.01.2000 ... 31.12.2099 Factory setting DD.MM.YYYY	Set the start date for the sampling program. The format depends on the option configured under general settings.
Start time	00:00:00 ... 23:59:59 Factory setting HH:MM:SS (24h)	Set the time when the sampling program is started. The format depends on the option configured under general settings.
Stop condition	Selection <ul style="list-style-type: none"> ▪ Program end ▪ Continuous Factory setting Program end	Program end The device stops sampling automatically once it has run through the set program. Continuous The device runs through the set program continuously in an infinite loop. Do not forget to empty the bottles.
Assignment bin. output	Selection <ul style="list-style-type: none"> ▪ No binary output configured ▪ Binary output Sx Factory setting No binary output configured	Assignment of the binary output to the program cycle.
► Inputs		Settings for the inputs can be made as described in the "Inputs" section.

Settings with a Basic program and external signal

Settings with the Basic program type via an external signal with 1 bottle

Sampling mode = External signal

Menu/Setup/Sampling programs/Setup program/New/Basic		
Function	Options	Info
Sampling volume input	10 to 1000 ml Factory setting 100 ml	Enter the sample volume.
Sampling signal input	Selection No sampling input configured Factory setting No sampling input configured	Select the input for the sampling signal. The fieldbus must be configured for this function. The sampling input can be configured under ►Inputs .
Bottle change mode	Selection <ul style="list-style-type: none"> ■ Number of samples ■ Time ■ Number of samples Factory setting Number of samples	The bottle can be changed after a specific number of samples, after a time or by an external signal.
Having selected Bottle change mode Number of samples		
Samples per bottle	1 ... 9999 Factory setting 1	Set the number of samples.
Having selected Bottle change mode Time		
Time interval	00-00:02 ... 31-00:00 DD-HH:MM Factory setting 00-01:00 DD-HH:MM	Set the time (days, hours and minutes) after which the system should change to the next bottle.
Bottle synchronization	Selection <ul style="list-style-type: none"> ■ None ■ 1. bottle change time ■ 1. Time of change + bottle number Factory setting None	None The sampling and bottle change times are not synchronized. 1. bottle change time Sampling starts with the first bottle. Set the synchronization time. 1. Time of change + bottle number Each bottle is assigned to a specific fill time. Set the synchronization time and the weekday.
Start condition	Selection <ul style="list-style-type: none"> ■ Immediate ■ Date/time Factory setting Immediate	The sampling program can be started either immediately or at a specific, configurable time.
Having selected Start condition Immediate		
Sample at start	Selection <ul style="list-style-type: none"> ■ Yes ■ No Factory setting Yes	Yes The first sample is taken when the program is started. No The system waits for the interval to elapse before the first sample is taken.
Having selected Start condition Date/time		

Menu/Setup/Sampling programs/Setup program/New/Basic		
Function	Options	Info
Start date	01.01.2000 ... 31.12.2099 Factory setting DD.MM.YYYY	Set the start date for the sampling program. The format depends on the option configured under general settings.
Start time	00:00:00 ... 23:59:59 Factory setting HH:MM:SS (24h)	Set the time when the sampling program is started. The format depends on the option configured under general settings.
Stop condition	Selection <ul style="list-style-type: none"> ▪ Program end ▪ Continuous Factory setting Program end	Program end The device stops sampling automatically once it has run through the set program. Continuous The device runs through the set program continuously in an infinite loop. Do not forget to empty the bottles.
Assignment bin. output	Selection <ul style="list-style-type: none"> ▪ No binary output configured ▪ Binary output Sx Factory setting No binary output configured	Assignment of the binary output to the program cycle.
► Inputs		Settings for the inputs can be made as described in the "Inputs" section.

Settings with the Basic program type via an external signal with multiple bottles

Sampling mode = External signal

Menu/Setup/Sampling programs/Setup program/New/Basic		
Function	Options	Info
Sampling volume input	10 to 1000 ml Factory setting 100 ml	Enter the sample volume.
Sampling signal input	Selection No sampling input configured Factory setting No sampling input configured	Select the input for the sampling signal. The fieldbus must be configured for this function. The sampling input can be configured under ►Inputs .
Bottle change mode	Selection <ul style="list-style-type: none"> ▪ Number of samples ▪ Time ▪ Number of samples Factory setting Number of samples	The bottle can be changed after a specific number of samples, after a time or by an external signal.
Having selected Bottle change mode Number of samples		
Samples per bottle	1 ... 9999 Factory setting 1	Set the number of samples.
Having selected Bottle change mode Time		
Time interval	00-00:02 ... 31-00:00 DD-HH:MM Factory setting 00-01:00 DD-HH:MM	Set the time (days, hours and minutes) after which the system should change to the next bottle.

Menu/Setup/Sampling programs/Setup program/New/Basic		
Function	Options	Info
Having selected Bottle change mode External signal		
Bottle chg. sig. input	Selection <ul style="list-style-type: none"> ■ No bottle change input configured ■ Binary input Sx Factory setting No bottle change input configured	The bottle change input can be configured under ► Inputs . A binary input must be configured for this function. The sampling input can be configured under "Inputs".
Multiple bottles	0 ... 23 The configuration options depend on the current number of bottles Factory setting 0	Multiple bottles: "Simultaneous" transfer of two samples to separate bottles.
Start condition	Selection <ul style="list-style-type: none"> ■ Immediate ■ Date/time Factory setting Immediate	The sampling program can be started either immediately or at a specific, configurable time.
Having selected Start condition Immediate		
Sample at start	Selection <ul style="list-style-type: none"> ■ Yes ■ No Factory setting Yes	Yes The first sample is taken when the program is started. No The system waits for the interval to elapse before the first sample is taken.
Having selected Start condition Date/time		
Start date	01.01.2000 ... 31.12.2099 Factory setting DD.MM.YYYY	Set the start date for the sampling program. The format depends on the option configured under general settings.
Start time	00:00:00 ... 23:59:59 Factory setting HH:MM:SS (24h)	Set the time when the sampling program is started. The format depends on the option configured under general settings.
Stop condition	Selection <ul style="list-style-type: none"> ■ Program end ■ Continuous Factory setting Program end	Program end The device stops sampling automatically once it has run through the set program. Continuous The device runs through the set program continuously in an infinite loop. Do not forget to empty the bottles.
Assignment bin. output	Selection <ul style="list-style-type: none"> ■ No binary output configured ■ Binary output Sx Factory setting No binary output configured	Assignment of the binary output to the program cycle.
► Inputs		Settings for the inputs can be made as described in the "Inputs" section.

10.3.3 Program types: Standard and Advanced

Standard program:

Comprises a maximum of five subprograms

Advanced program:

- Comprises a maximum of 24 subprograms.
- These subprograms can be run simultaneously or consecutively.
- Each event subprogram can consist of up to 3 conditions.
- As the device contains dual bottle trays, you can assign a program easily, and easily detect a change in the program.

Settings for the Standard program

Menu/Setup/Sampling programs		
Function	Options	Info
▶Setup program		
New		A list of all the programs created is displayed. For this reason, it is often helpful to add an "S" for Standard in the program name.
▶Standard		
Program name	Free text	Use a distinct name for your sampling program. The program name can be up to 16 characters long.
Bottle volume	0 to 100000 ml 0 to 20000 ml Factory setting <ul style="list-style-type: none"> ■ 30000 ml ■ 20000 ml 	Set the bottle volume. The preset value depends on the bottle configuration configured. The bottle volume is always 30 l for individual containers. The preset value depends on the bottle configuration. The bottle volume is always 20 l for individual containers. In the case of asymmetric distribution, e.g. 6 x 3 l + 2 x 13 l, you can set the bottle volume on the left and right in the menu items that follow.
Bottle configuration	Choice of all possible bottle combinations	The ordered bottle configuration is preset or the configuration selected in the setup is displayed.
Start condition	Selection <ul style="list-style-type: none"> ■ Immediate ■ Date/time ■ Volume Factory setting Immediate	The sampling program can be started either immediately, at a specific, configurable time, or when a certain totalized flow is reached.
Having selected Start condition Date/time		
Start time	00:00:00 ... 23:59:59 Factory setting HH:MM:SS (24h)	Set the time when the sampling program is started. The format depends on the option configured under general settings.
Start date	01.01.2000 ... 31.12.2099 Factory setting DD.MM.YYYY	Set the start date for the sampling program. The format depends on the option configured under general settings.
Having selected Start condition Volume		
Start volume input	Selection <ul style="list-style-type: none"> ■ No flow input configured ■ Binary input S:x ■ Current input S:x Factory setting No flow input configured	Select the start volume input. The binary input or the current input must be configured for this function. Only the inputs configured for flow measurement are displayed.
Start flow sum	1000 to 9,999,000 m ³ Factory setting 10,000 m ³	Set the start volume.

Menu/Setup/Sampling programs		
Function	Options	Info
Stop condition	Selection <ul style="list-style-type: none"> ■ Program end ■ Continuous ■ Date/time Factory setting Program end	Program end The device stops sampling automatically once it has run through the set program. Continuous The device runs through the set program continuously in an infinite loop. Do not forget to empty the bottles. Date/time The device stops the set program at a specific time.
Having selected Start condition Date/time		
Stop date	01.01.2000 ... 31.12.2099 Factory setting DD.MM.YYYY	Set the stop date for the sampling program. The format depends on the option configured under general settings.
Stop time	00:00:00 ... 23:59:59 Factory setting HH:MM:SS (24h)	Set the time when the sampling program is stopped. The format depends on the option configured under general settings.
▶Setup subprogram		
New		
Programpart		Use a distinct name for your subprogram. The program name can be up to 16 characters long.
Sampling mode	Selection <ul style="list-style-type: none"> ■ Time paced CTCV ■ Flow paced VTCV ■ Time/flow paced CTVV ■ External signal Factory setting	Time paced CTCV A constant sampling volume is taken at steady intervals. Flow paced VTCV A constant sampling volume is taken at variable intervals. Time override can be enabled in an advanced program. With time monitoring, it is possible to interrupt long, flow-controlled sampling intervals caused by a low flow rate. A sample which is also time-controlled is taken. Time/flow paced CTVV <ul style="list-style-type: none"> ■ (only for version with peristaltic pump) ■ A variable sampling volume is taken at steady intervals. External signal A pulse at the binary input starts a sampling cycle.
The settings that depend on the sampling mode are listed in the "Program type: Basic" section.		
Enable subprogram	Selection <ul style="list-style-type: none"> ■ Immediate ■ Individual dates ■ Repeating date ■ Interval ■ Deactivation Factory setting Immediate	Immediate The subprogram is enabled immediately. Individual dates Set the start and stop dates for enabling the subprogram. Repeating date Set the start condition, activity time and repetition interval for the subprogram. Interval Set the start condition, activity time and inactivity time for the subprogram. Deactivation Subprogram 2 or 2+n is started as soon as subprogram 1 is disabled. Only possible with multiple subprograms.

Menu/Setup/Sampling programs		
Function	Options	Info
Having selected Enable subprogram Individual dates		
<p>► Individual dates Set the start and stop times for the subprogram. Enter a new date via "INSERT". Delete a date via "DELETE". You can assign a maximum of 25 start and stop dates.</p>		
Having selected Enable subprogram Repeating date		
Start condition	<p>Selection</p> <ul style="list-style-type: none"> ▪ No delay ▪ Date/Time ▪ Time ▪ No delay (sync) <p>Factory setting No delay (sync)</p>	<p>No delay The subprogram is started when the program is enabled.</p> <p>Date/Time Set the start date and start time for enabling the subprogram.</p> <p>Time Set the start time for enabling the subprogram.</p> <p>No delay (sync) Only possible on program start Immediate and with bottle assignment "Dynamic or Static".</p>
Activity time	<p>00:01 to 99:59 HH:MM</p> <p>Factory setting 00:01 HH:MM</p>	Specify how long the subprogram should be active in hours and minutes. The time to be selected depends on the setting for the repetition mode.
► Multiple date		
Repetition mode	<p>Selection</p> <ul style="list-style-type: none"> ▪ Daily interval ▪ Weekly interval ▪ Days of week <p>Factory setting Daily interval</p>	<p>Daily interval Specify whether the subprogram should be repeated every day.</p> <p>Weekly interval Specify whether the subprogram should be repeated every week.</p> <p>Days of week Specify whether the subprogram should be repeated on certain days of the week. --> Select the days of the week in the subsequent menu item.</p>
Repetition interval (only with Daily interval and Weekly interval)	<p>1 ... 999</p> <p>Factory setting 1</p>	Specify for how many days or weeks the subprogram should be active. Example: Repetition mode = daily interval Repetition interval = 2 The subprogram is enabled every second day from the start condition.
Having selected Enable subprogram Interval		
Ensure activation	<p>Selection</p> <ul style="list-style-type: none"> ▪ No ▪ Daily ▪ Weekly <p>Factory setting No</p>	Ensures that the subprogram is activated at the specified intervals. If necessary, the inactivity time is shortened by one day or one week.

Menu/Setup/Sampling programs		
Function	Options	Info
Start condition	Selection <ul style="list-style-type: none"> ■ No delay ■ Date/Time ■ Time ■ No delay (sync) Factory setting No delay (sync)	The subprogram is started when the program is enabled. Date/Time Set the start date and start time for enabling the subprogram. Time Set the start time for enabling the subprogram. No delay (sync) Only possible on program start Immediate and with bottle assignment "Dynamic or Static".
Start date	01.01.2000 ... 31.12.2099 Factory setting DD.MM.YYYY	Set the start date for the 1st interval. The format depends on the option configured under general settings.
Start time	00:00:00 ... 23:59:59 Factory setting 00-00:01 DD-HH:MM	Set the time for the 1st interval. The format depends on the option configured under general settings.
Activity time	00-00:01 ... 31-00:00 DD-HH:MM Factory setting 00-00:01 DD-HH:MM	Specify how long the subprogram should be active in days, hours and minutes. The subprogram always begins with an activation.
Inactivity time	00-00:01 ... 31-00:00 DD-HH:MM Factory setting 00-00:01 DD-HH:MM	Specify how long the subprogram should be inactive in days, hours and minutes.
Sample at enable	Selection <ul style="list-style-type: none"> ■ Yes ■ No Factory setting Yes	Specify whether the first sample should be taken directly when the subprogram is enabled. For example, with intervals, a sample is taken at the start of every activation interval.
Sample at disable	Selection <ul style="list-style-type: none"> ■ Yes ■ No Factory setting No	Specify whether a sample should be taken when the subprogram is disabled. For example, with intervals, a sample is taken at the end of every activation interval.
New bottle at disable	Selection <ul style="list-style-type: none"> ■ Yes ■ No Factory setting Yes	

Menu/Setup/Sampling programs		
Function	Options	Info
Bottle synchronization	<p>Selection</p> <ul style="list-style-type: none"> ▪ None ▪ 1. bottle change time ▪ 1. Time of change + bottle number ▪ External BC sync input <p>Factory setting None</p>	<p>Specific bottles can be assigned specific filling times with the bottle synchronization function. For example, bottle 1 is to be filled from midnight to 2 a.m., bottle 2 from 2 a.m. to 4 a.m. etc..</p> <p>None The sampling and bottle change times are not synchronized.</p> <p>1. bottle change time Sampling starts with the first bottle. The change to the next bottle is synchronized.</p> <p>1. Time of change + bottle number Each bottle is allocated a specific filling time.</p> <p>External BC sync input The system changes to the next bottle when an external signal is received. The external signal first has to be configured via the binary input. The binary input can then be selected as the source.</p>
Assignment bin. output	<p>Selection</p> <ul style="list-style-type: none"> ▪ No binary output configured ▪ Binary output S:x <p>Factory setting No binary output configured</p>	<p>Assignment of the binary output to the program cycle.</p>
<p>Use "SAVE" to save the subprogram setup. Then press "ESC" to return to the main program. A prompt to save the program appears if you have not yet saved the subprogram. You can avoid saving the program by pressing "ESC".</p>		
<p>►Inputs</p>		<p>Settings for the inputs can be made as described in the "Inputs" section.</p>
<p>Bottle assignment (only possible with multiple bottles) This menu item appears when more than one bottle is available, regardless of the number of subprograms.</p>	<p>Selection</p> <ul style="list-style-type: none"> ▪ No bottle assignment ▪ Dynamical bottle assignment ▪ Statical bottle assignment <p>Factory setting Dynamical bottle assignment</p>	<p>No bottle assignment: Each subprogram fills the same bottle until the bottle is full. All the subprograms then change to the next bottle. Only visible if there is more than one subprogram.</p> <p>Dynamical bottle assignment: When the subprogram changes, the system switches to the next empty bottle</p> <p>Statical bottle assignment: A table can be used to assign a subprogram to each bottle</p>
<p>Via the "Bottle change" menu item, the bottle change can be configured after a certain time or number of samples if bottle distribution with more than one bottle has been selected and either dynamic or static bottle assignment has been selected.</p>		
<p>Having selected Bottle assignment Statical bottle assignment:</p>		
<p>►Bottle assignment table Select a bottle and assign it a subprogram.</p>		

Settings for the Advanced program

Menu/Setup/Sampling programs		
Function	Options	Info
▶ Setup program		
New		A list of all the programs created is displayed. For this reason, it is often helpful to add an "S" for Standard in the program name.
▶ Advanced		
Program name	Free text	Use a distinct name for your sampling program. The program name can be up to 16 characters long.
Bottle configuration	Choice of all possible bottle combinations	The ordered bottle configuration is preset or the configuration selected in the setup is displayed.
Bottle volume	0 to 100000 ml Factory setting ▪ 30000 ml ▪ 20000 ml	Set the bottle volume. The preset value depends on the bottle configuration configured. The bottle volume is always 30 l for individual containers. The preset value depends on the bottle configuration. The bottle volume is always 20 l for individual containers. In the case of asymmetric distribution, e.g. 6 x 3 l + 2 x 13 l, you can set the bottle volume on the left and right in the menu items that follow.
Start condition	Selection ▪ Immediate ▪ Date/time ▪ Volume ▪ External start ▪ External duration Factory setting Immediate	Immediate The sampling program is started immediately. Date/time The sampling program is started at a specific time that can be configured. Volume The sampling program is started when a certain totalized flow is reached. External start The sampling program is started by a pulse at the configured binary input. External duration The sampling program is active as long as the configured input has the corresponding level
Having selected Start condition Date/time		
Start date	01.01.2000 ... 31.12.2099 Factory setting DD.MM.YYYY	Set the start date for the sampling program. The format depends on the option configured under general settings.
Start time	00:00:00 ... 23:59:59 Factory setting HH:MM:SS (24h)	Set the time when the sampling program is started. The format depends on the option configured under general settings.
Having selected Start condition Volume		
Start volume input	Selection ▪ No flow input configured ▪ Binary input S:x ▪ Current input S:x Factory setting No flow input configured	Select the start volume input. The binary input or the current input must be configured for this function. Only the inputs configured for flow measurement are displayed.

Menu/Setup/Sampling programs		
Function	Options	Info
Start flow sum	1000 to 9,999,000 m ³ Factory setting 10,000 m ³	Set the start volume.
Having selected Start condition External start		
Start signal input	Selection <ul style="list-style-type: none"> ■ No program start input configured ■ Binary input S:x ■ Factory setting No program start input configured	Select the program start input. The binary input must be configured for this function. Only the inputs configured as a program start input are displayed.
Having selected Start condition External duration		
Start signal input	Selection <ul style="list-style-type: none"> ■ No program start input configured ■ Binary input S:x ■ Factory setting No program start input configured	Select the program duration input. The binary input must be configured for this function. Only the inputs configured as a program start input are displayed.
Having selected Start condition PROFIBUS DP or Modbus		
Start signal input	Selection <ul style="list-style-type: none"> ■ None ■ %0V DO 01 ■ %0V DO 02 ■ %0V DO 03 ■ %0V DO 04 ■ %0V DO 05 ■ %0V DO 06 ■ %0V DO 07 ■ %0V DO 08 Factory setting None	Select the program start input.
Stop condition (not for external start)	Selection <ul style="list-style-type: none"> ■ Program end ■ Continuous ■ Date/time ■ External duration Factory setting Program end	Program end The device stops sampling automatically once it has run through the set program. Continuous The device runs through the set program continuously in an infinite loop. Do not forget to empty the bottles. External duration The device stops the set program if a pulse is sent to a binary input configured accordingly.
Having selected Stop condition Date/time		
Stop date	01.01.2000 ... 31.12.2099 Factory setting DD.MM.YYYY	Set the stop date for the sampling program. The format depends on the option configured under general settings.
Stop time	00:00:00 ... 23:59:59 Factory setting HH:MM:SS (24h)	Set the time when the sampling program is stopped. The format depends on the option configured under general settings.
Having selected Stop condition External signal		

Menu/Setup/Sampling programs		
Function	Options	Info
Stop signal input	<p>Selection</p> <ul style="list-style-type: none"> ▪ No program start input configured ▪ Binary input S:x ▪ <p>Factory setting No program start input configured</p>	Select the program stop input. The binary input must be configured for this function. Only the inputs configured as a program stop input are displayed.
Having selected Stop condition PROFIBUS DP or Modbus		
Stop signal input	<p>Selection</p> <ul style="list-style-type: none"> ▪ None ▪ %0V DO 01 ▪ %0V DO 02 ▪ %0V DO 03 ▪ %0V DO 04 ▪ %0V DO 05 ▪ %0V DO 06 ▪ %0V DO 07 ▪ %0V DO 08 <p>Factory setting None</p>	Select the program stop input.
▶ Setup subprogram		
New		
Programpart		Use a distinct name for your subprogram. The program name can be up to 16 characters long.
Sampling mode	<p>Selection</p> <ul style="list-style-type: none"> ▪ Time paced CTCV ▪ Flow paced VTCV ▪ Time/flow paced CTVV ▪ Single sample ▪ Sampling table ▪ External signal ▪ <p>Factory setting Flow paced VTCV</p>	<p>Time paced CTCV A constant sampling volume is taken at steady intervals.</p> <p>Flow paced VTCV A constant sampling volume is taken at variable intervals.</p> <p>Time/flow paced CTVV A variable sampling volume is taken at steady intervals.</p> <p>Single sample The device takes a single sample with a specific volume.</p> <p>Sampling table The time and the sampling volume is assigned to a certain bottle in the sampling table.</p> <p>External signal A sample is taken when an external signal is received.</p>
The settings that depend on the sampling mode (time-paced, flow-paced and time/flow-paced sampling) are listed in the "Program type: Basic" section.		
Having selected Sampling mode Single sample		
Dosing volume (for version with vacuum pump or sampling assembly) Sampling volume (for version with peristaltic pump)	<p>Vacuum pump: 20 to 350 ml Peristaltic pump: 10 to 10000 ml Sampling assembly: 10 to 1000 ml</p> <p>Factory setting Vacuum pump: 200 ml Peristaltic pump: 100 ml Sampling assembly: 200 ml</p>	<p>Depending on the version, set the dosing volume or the sampling volume The volume is taken from the setup in the version with a vacuum pump or sampling assembly. The dosing accuracy and the repeatability of a sample volume < 20 ml may vary depending on the specific application</p>

Menu/Setup/Sampling programs		
Function	Options	Info
Sampling volume	10 to 10000 ml Factory setting 100 ml	Set the sampling volume. The dosing accuracy and the repeatability of a sample volume < 20 ml may vary depending on the specific application
Having selected Sampling mode Sampling table		
<p>►Sampling table Assign the time and sampling volume to a certain bottle. Add a new entry via "INSERT". Delete an entry via "DELETE". You can make a maximum of 24 entries.</p>		
<p>Example:</p> <ul style="list-style-type: none"> ▪ Bottle 1 ▪ Bottle 2 	<p>Example:</p> <ul style="list-style-type: none"> ▪ Delta (=waiting time): 01:00:00 ▪ Delta (=waiting time): 00:10:00 	<ul style="list-style-type: none"> ▪ Volume: 100 ml ▪ Volume: 100 ml
<p>1st sampling one hour after program start: 100 ml in bottle 1 2nd sampling 10 minutes later: 100 ml in bottle 2 The sampling table indicates: After the defined "Delta time" (column 2) the volume of column 3 will be dosed into the bottle of column 1.</p>		
Enable subprogram	<p>Selection</p> <ul style="list-style-type: none"> ▪ Immediate ▪ Individual dates ▪ Repeating date ▪ Interval ▪ Event ▪ External start ▪ Deactivation <p>Factory setting Immediate</p>	<p>Immediate The subprogram is enabled immediately.</p> <p>Individual dates Set the start and stop dates for enabling the subprogram.</p> <p>Repeating date Set the start condition, activity time and repetition interval for the subprogram.</p> <p>Interval Set the start condition, activity time and inactivity time for the subprogram.</p> <p>Event The subprogram is enabled by an event. Up to three measuring signals are linked to form a start signal using "and"/"or" links.</p> <p>External start The subprogram is enabled by a pulse at a binary input configured accordingly.</p> <p>Deactivation Subprogram 2 or 2+n is started as soon as subprogram 1 is disabled. Only possible with multiple subprograms.</p>
Having selected Enable subprogram Event		
Start condition	<p>Selection</p> <ul style="list-style-type: none"> ▪ No delay ▪ Date/Time ▪ Time <p>Factory setting Date/Time</p>	<p>No delay The subprogram is started when the program is enabled.</p> <p>Date/Time Set the start date and start time for enabling the subprogram.</p> <p>Time Set the start time for enabling the subprogram.</p>
► Activation event		
Number of events	<p>Selection</p> <ul style="list-style-type: none"> ▪ 1 ▪ 2 ▪ 3 <p>Factory setting 1</p>	Specify how many measuring inputs (1-3) you want to link to generate an activation signal.

Menu/Setup/Sampling programs		
Function	Options	Info
<p>► Event Editor 1 If you have more than one event editor, the "Event editor" menu item appears often. Use the "Link" menu item to configure the logical link between the signals.</p>		
Source of data	<p>Selection</p> <ul style="list-style-type: none"> ▪ None ▪ Binary input S:x ▪ Current input S:x ▪ Temperature Input ▪ Fieldbus <p>Factory setting None</p>	Select the input via which the activation event is to be output. The inputs are configured in the menu Setup Inputs . The binary inputs are only visible if they have been configured accordingly (rainfall or flow).
Measured value	<p>Options (depends on sensor/data source)</p> <ul style="list-style-type: none"> ▪ None ▪ Totalized flow ▪ Current ▪ Temperature ▪ PROFIBUS AO 0x <p>Factory setting None</p>	
Operating mode	<p>Selection</p> <ul style="list-style-type: none"> ▪ Upper limit ▪ Lower limit ▪ Within range ▪ Out of range ▪ Rate of change <p>Factory setting Upper limit</p>	Type of limit value monitoring: <ul style="list-style-type: none"> ▪ Limit value overshoot or undershoot ▪ Measured value within or outside a range ▪ Rate of change
Limit value	<p>Range of adjustment and factory setting Depends on the measured value</p>	<p>Operating mode = Above limit check or Below limit check</p> <ul style="list-style-type: none"> ▪ The event is triggered if the limit value + hysteresis is exceeded for the switch-on duration. ▪ The event is reset again if the limit value - hysteresis is undershot for the duration of the switch-off delay at least.
Range lower value	<p>Range of adjustment and factory setting Depends on the measured value</p>	<p>Operating mode = In range check or Out of range check</p> <ul style="list-style-type: none"> ▪ The event is triggered if the range lower value + hysteresis is exceeded for the switch-on duration. ▪ The event is reset again if the range upper value - hysteresis is undershot for the duration of the switch-off delay at least.
Range upper value		
Hysteresis	<p>Range of adjustment and factory setting Depends on the measured value</p>	The hysteresis is the difference between the switch-on point and the switch-off point if values, which cause the limit switch to pick up, become closer or move further apart. It is needed to ensure a stable switching behavior.
Start delay	0 to 9999 s	Synonyms: pick-up and drop-out delay
Switch off delay	<p>Factory setting 0 s</p>	
Delta value	<p>Range of adjustment and factory setting Depends on the measured value</p>	<p>Operating mode = Change rate The event is triggered if the measured value changes by at least the delta value (both positive and negative) within the set delta time. The event is deleted as soon as the rate of change is lower than the set value and the auto confirmation time has elapsed.</p>

Menu/Setup/Sampling programs		
Function	Options	Info
Delta time	00:01 ... 23:59 Factory setting 01:00	
Auto Confirm	00:01 ... 23:59 Factory setting 01:00	
Having selected Activation input External start		
Activation input	Selection <ul style="list-style-type: none"> ▪ No program part start input configured ▪ Binary input S:x Factory setting No program part start input configured	Select the input for start of the subprogram. The binary input must be configured for this function. Only the configured inputs are displayed.
Sample at enable (not for single sample and sampling table and also not for "Immediate" and event)	Selection <ul style="list-style-type: none"> ▪ Yes ▪ No Factory setting Yes	Specify whether the first sample should be taken directly when the subprogram is enabled. For example, with intervals, a sample is taken at the start of every activation interval.
Sample at disable	Selection <ul style="list-style-type: none"> ▪ Yes ▪ No Factory setting No	Specify whether a sample should be taken when the subprogram is disabled. For example, with intervals, a sample is taken at the end of every activation interval.
Deactivation	Selection <ul style="list-style-type: none"> ▪ Bottles full ▪ Enable invalid ▪ Deactivation with event Factory setting Enable invalid	Select the disable function of the subprogram: Bottles full The subprogram is disabled once all the assigned bottles have been filled. Enable invalid Disable via limit value Deactivation with event New parameter can be defined
Bottle change mode	Selection <ul style="list-style-type: none"> ▪ No ▪ Yes Factory setting Yes	No The bottle is changed following a disable/enable Yes When the cycle is finished, the system continues filling the last bottle.
Synchronize samplings	Selection <ul style="list-style-type: none"> ▪ To subprogram start ▪ To clock Factory setting	To subprogram start The intervals defined in the sampling mode are enabled when the subprogram is started. To clock The intervals defined in the sampling mode are enabled after a specific time. For example, if 30 min is entered this means that the interval is only activated at a time of xx:30. --> You configure this time in the " Offset synchronization " menu item.

Menu/Setup/Sampling programs		
Function	Options	Info
Bottle synchronization	<p>Selection</p> <ul style="list-style-type: none"> ▪ None ▪ 1. bottle change time ▪ 1. Time of change + bottle number ▪ External BC sync input <p>Factory setting None</p>	<p>Specific bottles can be assigned specific filling times with the bottle synchronization function. For example, bottle 1 is to be filled from midnight to 2 a.m., bottle 2 from 2 a.m. to 4 a.m. etc..</p> <p>None The sampling and bottle change times are not synchronized.</p> <p>1. bottle change time Sampling starts with the first bottle. The change to the next bottle is synchronized.</p> <p>1. Time of change + bottle number Each bottle is allocated a specific filling time.</p> <p>External BC sync input The system changes to the next bottle when an external signal is received. The external signal first has to be configured via the binary input. The binary input can then be selected as the source.</p>
Assignment bin. output	<p>Selection</p> <ul style="list-style-type: none"> ▪ No binary output configured ▪ Binary output S:x <p>Factory setting No binary output configured</p>	<p>Assignment of the binary output to the program cycle.</p>
Use "SAVE" to save the subprogram setup. Then press "ESC" to return to the main program.		
▶ Inputs		Settings for the inputs can be made as described in the "Inputs" section.
<p>Bottle assignment (only possible with multiple bottles) This menu item appears when more than one bottle is available, regardless of the number of subprograms.</p>	<p>Selection</p> <ul style="list-style-type: none"> ▪ No bottle assignment ▪ Dynamical bottle assignment ▪ Statical bottle assignment ▪ Statical bottle assignment <p>Factory setting Dynamical bottle assignment</p>	<p>No bottle assignment: Each subprogram fills the same bottle until the bottle is full. All the subprograms then change to the next bottle. Only visible if there is more than one subprogram.</p> <p>Dynamical bottle assignment: When the subprogram changes, the system switches to the next empty bottle</p> <p>Statical bottle assignment: A table can be used to assign a subprogram to each bottle</p>
Via the "Bottle change" menu item, the bottle change can be configured after a certain time or number of samples if bottle distribution with more than one bottle has been selected and either dynamic or static bottle assignment has been selected.		
Having selected Bottle assignment Statical bottle assignment:		
▶ Bottle assignment table Select a bottle and assign it a subprogram.		

10.3.4 Selecting and executing the program

In the overview, under **Select sampling program** you can see all the programs created. Here you can also use **New** to create a new program.

Using the navigator, you can select the program you want to execute here and then choose from the following menu items:

- Edit
- Start
- Duplicate
- Cancel

Setup program	
Function	Info
▶ Edit	The selected program is displayed and can be edited. Press the "SAVE" button to save the changes.
▶ Delete	The selected program is deleted following a confirmation prompt.
▶ Start	The selected program is started immediately. The program can be canceled or paused by pressing the OFF button. If there are differences between the setup and the selected program, the Program configuration contains errors message appears, e.g. the bottle configuration in the program does not match the configuration in the setup. The program is not started. In this example, the actual bottle configuration must be checked against the configuration in the setup and the program and changed accordingly. Only the bottle configuration entered in the setup is valid for the program to be executed.
▶ Duplicate	The selected program is duplicated and saved with an ID.
▶ Cancel	Back to the overview.

The **Setup program** display features the **ESC**, **MAN**, **?** and **MODE** softkeys.

The **Program enabled** display features the **ESC**, **STAT** and **MODE** softkeys.

Setup program	
Function	Info
▶ ESC	Back to the overview. Any program currently running is canceled.
▶ MAN	Manual sampling can be configured and started here. Any program currently running is paused. -> See "Sampling program/Manual sampling" section
▶ ?	A help text is displayed for the item.
▶ STAT	For selecting statistics about measured values, sampling and inputs, see the "Display behavior" section.
▶ MODE	If no program is enabled, the device can be switched off here. If a program is enabled, the following options appear: Power down sampler: Following a confirmation prompt, the device is set to the standby mode. Power continues to be supplied to the device and the LED flashes green. The display goes dark. Stop program %OV: ¹⁾ Stops a program currently running following a confirmation prompt. The overview display appears. Pause program %OV: Is selected if maintenance work is pending. The program is paused and the pause time is entered in the logbook. After pressing the Resume program button, the current program is continued.

1) "%OV" here stands for text that depends on the context. This text is generated automatically by the software and inserted in place of %OV. In the simplest scenario, this could be the name of the measuring channel, for example.

10.4 Inputs

Liquiport 2010 CSP44 is fitted with the number of inputs specified in the order option. Galvanically isolated from one another

10.4.1 Binary inputs

The binary inputs are used to control the sampler using external signals.

With the CSP 44, the power supply of 24 V DC from the multiple I/O socket can be used for floating contacts (see the "Electrical connection" section).

Menu/Setup/Inputs		
Function	Options	Info
▶ Binary input S:x		
Mode	Selection <ul style="list-style-type: none"> ■ Off ■ On Factory setting Off	Switches the function on or off
Input variable	Selection <ul style="list-style-type: none"> ■ Flow rate ■ Rainfall ■ External event ■ Armature end position detection (only for version with sampling assembly) Factory setting Flow rate	<ul style="list-style-type: none"> ■ Pulse input for connected flowmeters or rain gages ■ Control of sampling functions via external signals
Having selected Input variable Flow rate		
Signal slope	Selection <ul style="list-style-type: none"> ■ Low-High ■ High-Low Factory setting Low-High	Preselect the level change of the signal.
Unit	Selection <ul style="list-style-type: none"> ■ m³ ■ l ■ cf ■ gal Factory setting m ³	Select the unit.
Meas. value format	Factory setting #.#	Specify the number of decimal places for the flow.
1 Impulse =	0 to 1000 m ³ Factory setting 10 m ³	Definition of the pulse value, limits are calculated depending on the unit
▶ Unit of totalized flow		
Current totalized flow	- - -	The totalized flow values are displayed.
Reset totalizer	Selection <ul style="list-style-type: none"> ■ Manual ■ Automatic ■ At program start Factory setting Manual	Manual Reset the counter manually. Automatic The counter is reset automatically at intervals. At program start The counter is reset at program start.
Having selected Reset totalizer Manual		
▷ Reset totalized flow	Action	The totalized flow currently calculated is set to zero when the counter is reset.
Having selected Reset totalizer Automatic		

Menu/Setup/Inputs		
Function	Options	Info
Interval	Selection <ul style="list-style-type: none"> ▪ Daily ▪ Weekly ▪ Monthly Factory setting Daily	Daily If a daily interval is selected, set the Time . Weekly If a weekly interval is selected, set the Day of week and the Time . Monthly If a monthly interval is selected, set the Day of month and the Time .
Time	00:00:00 ... 23:59:59 HH:MM:SS Factory setting 12:00:00 HH:MM:SS	
Having selected Input variable Rainfall		
Signal slope	Selection <ul style="list-style-type: none"> ▪ Low-High ▪ High-Low Factory setting Low-High	Preselect the level change of the signal.
Unit	Selection <ul style="list-style-type: none"> ▪ mm ▪ inch Factory setting mm	Select the unit.
Meas. value format	Factory setting #. #	Specify the number of decimal places.
1 Impulse =	0.00 to 5.00 mm Factory setting 1.0 mm	Definition of the pulse value, limits are calculated depending on the unit. The correct switch value is provided in the Operating Instructions of your rain gage.
Intensity	Selection <ul style="list-style-type: none"> ▪ mm/min ▪ mm/h ▪ mm/d Factory setting mm/min	Select the intensity per minute, hour or day according to your requirements.
► Totalized rainfall		
Totalized rainfall	- - -	The totalized rainfall is displayed.
Reset totalizer	Selection <ul style="list-style-type: none"> ▪ Manual ▪ Automatic ▪ At program start Factory setting Manual	Manual Reset the counter manually. Automatic The counter is reset automatically at intervals. At program start The counter is reset at program start.
Having selected Reset totalizer Manual		
▷ Reset totalized rainfall	Action	The totalized rainfall currently calculated is set to zero when the meter is reset manually.
Having selected Reset totalizer Automatic		

Menu/Setup/Inputs		
Function	Options	Info
Interval	Selection <ul style="list-style-type: none"> ▪ Daily ▪ Weekly ▪ Monthly Factory setting Daily	Daily If a daily interval is selected, set the Time . Weekly If a weekly interval is selected, set the Day of week and the Time . Monthly If a monthly interval is selected, set the Day of month and the Time .
Time	00:00:00 ... 23:59:59 HH:MM:SS Factory setting 12:00:00 HH:MM:SS	
Input variable External event		
Signal slope	Selection <ul style="list-style-type: none"> ▪ Low-High ▪ High-Low Factory setting Low-High	Preselect the level change of the signal. --> If Low-High is selected, the high level brings about the corresponding setting.
Having selected Input variable Armature end position detection (only for version with sampling assembly)		
Position	Selection <ul style="list-style-type: none"> ▪ Off ▪ Front (sampling) ▪ Back (dosing) Factory setting Off	Setting specifying the assembly position (front or back) to which the end position sensor is connected.
▷ Binary input assignment view		Overview of the outputs to which this binary input is linked.

10.4.2 Current inputs

The current input must be assigned an analog signal for the functions described.

For the correct wiring of the current inputs see the "Electrical connection" section →  17

Menu/Setup/Inputs		
Function	Options	Info
▶ Current input S:x		
Mode	Selection <ul style="list-style-type: none"> ▪ Off ▪ 0..20 mA ▪ 4..20 mA Factory setting Off	Enter the output signal of the connected device: 0 to 20 mA or 4 to 20 mA.

Menu/Setup/Inputs		
Function	Options	Info
Input variable	Selection <ul style="list-style-type: none"> ▪ Flow rate ▪ Parameter ▪ Current Factory setting Current	Select the input variable. Flow rate The input can be used as the source for time/flow-paced or flow-paced sampling programs. Parameter The input can be used as the source for limit switches, logbooks and enabling and disabling events for sampling programs. Current The input can be used as the source for limit switches, logbooks and enabling and disabling events for sampling programs. A unit name cannot be specified.
Having selected Input variable Flow rate		
Unit of flow	Selection <ul style="list-style-type: none"> ▪ l/s ▪ m³/s ▪ m³/h ▪ m³/d ▪ cfs ▪ gpm ▪ gph ▪ mgd Factory setting l/s	Select the unit.
Unit of totalized flow	Selection <ul style="list-style-type: none"> ▪ l ▪ m³ ▪ cf ▪ gal Factory setting m ³	Select the unit for the totalized flow.
Meas. value format	Factory setting #.#	Specify the number of decimal places for the flow.
Minimum flow	0 to 10000 l/s Factory setting 0 l/s	The set limit value prevents sampling if the flow falls below this value (only for time/flow-paced sampling).
Lower range value	0 to 10000 l/s Factory setting 0 l/s	Enter a value for the start of the measuring range. 0/4 mA is assigned to this value as per your specifications.
Upper range value	0 to 10000 l/s Factory setting 100000 l/s	Enter a value for the end of the measuring range. 20 mA is assigned to this value as per your specifications.
Damping	0 ... 60 s Factory setting 0 s	The damping causes a floating average curve of the measured values over the time specified.
► Totalized flow  The totalized flow is calculated when the program is started if you use a sampling program with volume, flow-paced sampling or time/flow-paced sampling as the start condition. The samples are taken based on this value. The current totalizer is used for calculating purposes if the totalized flow is used as the measured value for an enabling or disabling event.		
Current totalized flow	- - -	The totalized flow values are displayed.

Menu/Setup/Inputs		
Function	Options	Info
Reset totalizer	Selection <ul style="list-style-type: none"> ■ Manual ■ Automatic ■ At program start Factory setting Manual	Manual Reset the counter manually. Automatic The counter is reset automatically at intervals. At program start The counter is reset at program start.
Flow rate	- - -	The current flow rate is displayed.
Having selected Reset totalizer Manual		
▷ Reset totalized flow	Action	The totalized flow currently calculated is set to zero when the counter is reset.
Having selected Reset totalizer Automatic		
Interval	Selection <ul style="list-style-type: none"> ■ Daily ■ Weekly ■ Monthly Factory setting Daily	Daily If a daily interval is selected, set the Time menu item. Weekly If a weekly interval is selected, set the Day of week and the Time menu item. Monthly If a monthly interval is selected, set the Day of month and the Time menu item.
Having selected Input variable Parameter		
Meas. value format	Factory setting #.#	Specify the number of decimal places.
Parameter name	Free text	Assign a name.
Unit of measure	Free text	Enter the engineering unit.
Lower range value	-20 ... 10000 Factory setting 0	Enter a value for the start of the measuring range. 0/4 mA is assigned to this value as per your specifications.
	-20 ... 10000 Factory setting 10	Enter a value for the end of the measuring range. 20 mA is assigned to this value as per your specifications.
Upper range value	0 ... 60 s Factory setting 0 s	The damping causes a floating average curve of the measured values over the time specified.
Having selected Input variable Current		
Meas. value format	Factory setting #.#	Specify the number of decimal places.
Damping	0 ... 60 s Factory setting 0 s	The damping causes a floating average curve of the measured values over the time specified.

10.5 Outputs

10.5.1 Binary outputs (optional)

Up to two binary outputs are available as an option.

Possible application --> For outputting a manipulated variable to connected actuators

 The binary output must be assigned in the program or subprogram before it can be activated.

Menu/Setup/Outputs		
Function	Options	Info
▶ OutputBinary		
Function	<p>Selection</p> <ul style="list-style-type: none"> ▪ Off ▪ Event ▪ Limit value ▪ Diagnostics message ▪ Cleaning (only for version with sensors with the Memosens protocol) <p>Factory setting Off</p>	<p>The following functions depend on the option selected. Function = "Off" switches off the function of the binary output and means no further settings are required.</p> <p> In Cleaning: The outputs can only switch 100mA. A relay must be added to control valves or motors.</p>
Having selected Function Event		
Signal slope	<p>Selection</p> <ul style="list-style-type: none"> ▪ Low-High ▪ High-Low <p>Factory setting Low-High</p>	Select the level change of the signal
Event	<p>Selection</p> <ul style="list-style-type: none"> ▪ Program enabled ▪ End of program ▪ Sampling start ▪ End of sampling ▪ End of mult. samp. ▪ Dosing ▪ Sampling cycle ▪ Bottle change ▪ External stop ▪ No sample ▪ Sub program enabled ▪ Sub prog. activ. ▪ Sub prog. deactiv. <p>Factory setting Sampling cycle</p>	<p>Program enabled A permanent signal is switched when the sampling program starts.</p> <p>End of program A pulse or permanent signal is switched when the sampling program ends.</p> <p>Sampling start A pulse is switched when a sample is taken.</p> <p>End of sampling A pulse is switched when sampling has ended.</p> <p>End of mult. samp. A pulse is switched when sampling of the last multiple bottle has ended.</p> <p>Dosing A pulse is switched at the start of dosing.</p> <p>Sampling cycle The output signal is switched for the duration of the sampling cycle.</p> <p>Bottle change A pulse is switched when a bottle is changed.</p> <p>External stop A pulse is switched when an external stop is performed.</p> <p>No sample The output signal is switched if no sample was taken.</p> <p>Sub program enabled The output signal is switched if this subprogram is active.</p> <p>Sub prog. activ. The output signal is switched when the subprogram starts.</p> <p>Sub prog. deactiv. The output signal is switched when the subprogram ends.</p>
Having selected Function Limit value		

Menu/Setup/Outputs		
Function	Options	Info
Signal slope	Selection <ul style="list-style-type: none"> ▪ Low-High ▪ High-Low Factory setting Low-High	Preselect the level change of the signal.
Source of data	Selection <ul style="list-style-type: none"> ▪ None ▪ Limit switch 1-8 Factory setting None	Select the limit switch via which the status of the relay is to be output. The limit switches are configured in the menu " Setup/Additional functions/Limit switch ".
Having selected Function Diagnostics message		
Signal slope	Selection <ul style="list-style-type: none"> ▪ Low-High ▪ High-Low Factory setting Low-High	Preselect the level change of the signal.
Operating mode	Selection <ul style="list-style-type: none"> ▪ as assigned ▪ Namur M ▪ Namur S ▪ Namur C ▪ Namur F Factory setting as assigned	as assigned If this option is selected, the diagnostics messages which you have individually assigned to the binary output are output via the binary output. Namur M to F If you decided to use one of the Namur classes, all the messages that are assigned to the individual class are output via the binary output. You can also change the Namur class assignment for every diagnostics message. (Menu/Setup/General settings/Diagnostics/Device behavior or Menu/Setup/Inputs/.../Diagnostics settings/Diag. behavior)
▷Attributed diagnostic messages	Read-only list of diagnostic messages	All the messages assigned to the relay output appear on the display. You do not have the option of editing the information here.
Having selected Function Cleaning (only for version with sensors with the Memosens protocol)		
Signal slope	Selection <ul style="list-style-type: none"> ▪ Low-High ▪ High-Low Factory setting Low-High	Preselect the level change of the signal.
Assignment	Selection <ul style="list-style-type: none"> ▪ None ▪ Cleaning 1-4 Factory setting None	Use this function to choose the cleaning instance which should be started when the binary output is active.

10.5.2 Current outputs

Up to two current outputs are optionally available.



Setting the current output range

- ▶ **Menu/Setup/General settings:** Select **0..20 mA** or **4..20 mA**.

Possible applications

- For outputting a measured value to a process control system or an external recorder
- For outputting a manipulated variable to connected actuators

 The current output curve is always linear.

Menu/Setup/Outputs/Current output x:y ¹⁾		
Function	Options	Info
Current output	Selection <ul style="list-style-type: none"> ■ Off ■ On Factory setting Off	Use this function to activate or deactivate a variable being output at the current output
Source of data	Selection <ul style="list-style-type: none"> ■ None ■ Connected inputs ■ Temperature sensors Factory setting None	The sources of data on offer depend on your device version.
Measured value	Selection <ul style="list-style-type: none"> ■ None ■ Depends on the Source of data Factory setting None	The measured value you can select depends on the option selected under Source of data .
 The list of dependent measured values is provided in the Measured value table , subject to the Source of data →  89.		
Range lower value	Range of adjustment and factory settings depending on the Measured value	You can output the entire measuring range or just some of it at the current output. To do so, specify the upper and lower range values in accordance with your requirements.
Range upper value		
Hold behavior	Selection <ul style="list-style-type: none"> ■ Freeze last value ■ Fixed value ■ Ignore Factory setting Depends on the channel:output	Freeze last value The device freezes the last current value. Fixed value You define a fixed current value that is output at the output. Ignore A hold does not affect this current output.
Hold current	0.0 to 23.0 mA	► Specify which current should be output at this current output in the hold state.
Hold behavior = Fixed value	Factory setting 22.0 mA	

1) x:y = slot:output number

Measured value depending on the Source of data

Source of data	Measured value
pH Glass	Selection <ul style="list-style-type: none"> ■ Raw value mV ■ pH ■ Temperature
pH ISFET	
ORP	Selection <ul style="list-style-type: none"> ■ Temperature ■ ORP mV ■ ORP %

Source of data	Measured value
Oxygen (amp.)	Selection <ul style="list-style-type: none"> ▪ Temperature ▪ Partial pressure ▪ Concentration liquid ▪ Saturation ▪ Raw value nA (only Oxygen (amp.)) ▪ Raw value µs (only Oxygen (opt.))
Oxygen (opt.)	
Cond i	Selection <ul style="list-style-type: none"> ▪ Temperature ▪ Conductivity ▪ Resistance (only Cond c) ▪ Concentration (only Cond i and Cond c 4-pol)
Cond c	
Cond c 4-pol	
Disinfection	Selection <ul style="list-style-type: none"> ▪ Temperature ▪ Sensor current ▪ Concentration
ISE	Selection <ul style="list-style-type: none"> ▪ Temperature ▪ pH ▪ Ammonium ▪ Nitrate ▪ Potassium ▪ Chloride
TU/TS	Selection <ul style="list-style-type: none"> ▪ Temperature ▪ Turbidity g/l (only TU/TS) ▪ Turbidity FNU (only TU/TS) ▪ Turbidity Formazine (only TU) ▪ Turbidity solid (only TU)
TU	
Nitrate	Selection <ul style="list-style-type: none"> ▪ Temperature ▪ NO3 ▪ NO3-N
Ultrasonic interface	Selection <ul style="list-style-type: none"> ▪ Temperature ▪ Interface ▪ Turbidity
SAC	Selection <ul style="list-style-type: none"> ▪ Temperature ▪ SAC ▪ Transm. ▪ Absorption ▪ COD ▪ BOD
Current input 1 ... 3	Selection <ul style="list-style-type: none"> ▪ Bipolar (only for current outputs) ▪ Unipolar+ ▪ Unipolar-
Temperature 1 ... 3	
Mathematical functions	All the mathematical functions can also be used as a data source and the calculated value can be used as the measured value.

10.5.3 Alarm relays and optional relays, functions of the optional binary outputs

The basic version of the device always has one alarm relay. Additional relays are also available depending on the version of the device.

The following functions can be output via a relay:

- Limit switch status
- Controller manipulated variable for controlling an actuator
- Diagnostic messages
- Status of a cleaning function in order to control a pump or a valve

 You can assign a relay to multiple inputs in order to clean several sensors with just one cleaning unit, for example.

Menu/Setup/Outputs/Alarm relay or relay at channel no.		
Function	Options	Info
Function	<p>Selection</p> <ul style="list-style-type: none"> ▪ Off ▪ Limit switch ▪ Controller ▪ Diagnostics ▪ Cleaning (sensor) ▪ Formula (sensor) <p>Factory setting</p> <ul style="list-style-type: none"> ▪ Alarm relays: Diagnostics ▪ Other relays: Off 	<p>The following functions depend on the option selected. These versions are illustrated individually in the following sections to provide a clearer understanding of the options.</p> <p>Function = Off Switches off the relay function and means no further settings are required.</p>

Outputting the status of a limit switch

Function = Limit switch		
Function	Options	Info
Source of data	<p>Selection</p> <p>Limit switch 1 ... 8</p> <p>Factory setting</p> <p>None</p>	<p>Select the limit switch via which the status of the relay is to be output.</p> <p>The limit switches are configured in the menu: Setup/Additional functions/Limit switches.</p> <p> Use the ALL and NONE soft keys to select or deselect all the limit switches in one go.</p>
Hold behavior	<p>Selection</p> <ul style="list-style-type: none"> ▪ Freeze last value ▪ Fixed value ▪ Ignore <p>Factory setting</p> <p>Ignore</p>	

Outputting diagnostics messages via the relay

If a relay is defined as a diagnostic relay (**Function = Diagnostics**), it works in the "fail-safe mode".

This means that the relay is always energized ("normally closed", n.c.) in the basic state if an error is not present. In this way it can also indicate a drop in voltage, for example. The alarm relay always works in the failsafe mode.

You can output two categories of diagnostic messages via the relay:

- Diagnostic messages from one of the 4 Namur classes
- Diagnostic messages which you have individually assigned to the relay output

A message is individually assigned to the relay output at 2 specific points in the menu:

- **Menu/Setup/General settings/Extended setup/Diagnostics settings/Diag. behavior** (device-specific messages)
- **Menu/Setup/Inputs/<Sensor>/Extended setup/Diagnostics settings/Diag. behavior** (sensor-specific messages)

i Before being able to assign the relay output to a special message in **Diag. behavior** you must first configure **Outputs/Relay x:y** or **/Alarm relay/Function = Diagnostics**.

Function = Diagnostics		
Function	Options	Info
Operating mode	<p>Selection</p> <ul style="list-style-type: none"> ■ as assigned ■ Namur M ■ Namur S ■ Namur C ■ Namur F <p>Factory setting</p> <ul style="list-style-type: none"> ■ Relay: as assigned ■ Alarm relays: Namur F 	<p>as assigned</p> <p>If this option is selected, the diagnostic messages which you have individually assigned to the relay are output via the relay.</p> <p>Namur M ... Namur F</p> <p>If you decided to use one of the Namur classes, all the messages that are assigned to the individual class are output via the relay. You can also change the Namur class assignment for every diagnostic message.</p> <p>(Menu/Setup/General settings/Extended setup/Diagnostics settings/Diag. behavior or Menu/Setup/Inputs/<Sensor>/Extended setup/Diagnostics settings/Diag. behavior)</p>
Attributed diagnostic messages Operating mode = as assigned	Read only	All the messages assigned to the relay output appear on the display. You do not have the option of editing the information here.

Outputting the status of a cleaning function

Function = Cleaning		
Function	Options	Info
Assignments	<p>Selection</p> <ul style="list-style-type: none"> ■ None ■ Depends on the type of cleaning <p>Factory setting</p> <p>None</p>	<p>Here you can specify how a cleaning function should be displayed for the relay.</p> <p>You have the following options depending on the cleaning program that is selected (Menu/Setup/Additional functions/Cleaning):</p> <ul style="list-style-type: none"> ■ Cleaning type = Standard clean Cleaning 1 - Water, Cleaning 2 - Water, Cleaning 3 - Water, Cleaning 4 - Water ■ Cleaning type = Chemoclean Cleaning 1 - Water, Cleaning 1 - Cleaner, Cleaning 2 - Water, Cleaning 2 - Cleaner, Cleaning 3 - Water, Cleaning 3 - Cleaner, Cleaning 4 - Water, Cleaning 4 - Cleaner ■ Cleaning type = Chemoclean Plus 4x Cleaning 1 - %0V, 4x Cleaning 2 - %0V¹⁾
Hold behavior	<p>Selection</p> <ul style="list-style-type: none"> ■ Freeze last value ■ Fixed value ■ Ignore <p>Factory setting</p> <p>Ignore</p>	<p>Freeze last value</p> <p>The device freezes the last measured value.</p> <p>Fixed value</p> <p>You define a fixed measured value that is output at the output.</p> <p>Ignore</p> <p>A hold has no effect.</p>

1) %0V is variable text which you can assign in **Menu/Setup/Additional functions/Cleaning/Chemoclean Plus/Output label 1 ... 4**.

10.5.4 Modbus RS485 and Modbus TCP

Specify which process values should be output via Modbus RS485 Communication or via Modbus TCP.

In the case of Modbus RS485, you can switch between the RTU and the ASCII protocol.

You can define a maximum of 16 device variables.

1. Define the data source.
 - ↳ You can choose from sensor inputs and controllers.
2. Select the measured value to be output.
3. Define how the device should behave in the hold state. (Configuration options of **Source of data**, **Measured value** and **Hold behavior**) →  89

Please note that if you select **Hold behavior = Freeze**, the system not only flags the status but also actually "freezes" the measured value.



Further information on "Modbus" can be found in the Guideline for Communication via Modbus, SD01189C

11 Diagnostics and troubleshooting

11.1 General troubleshooting

The sampler continuously monitors its functions itself.

The color of the display background changes to red if a diagnostic message for error category "F" occurs.

The LED beside the display flashes red if a diagnostic message for error category "M" occurs.

11.1.1 Troubleshooting

A diagnostic message appears on the display, measured values are not plausible, or you identify a fault.

1. See the Diagnostics menu for details on the diagnostic message.
 - ↳ Follow the instructions to rectify the problem.
2. If this does not help, search for the diagnostic message under "Overview of diagnostic information" in these Operating Instructions. Use the message number as a search criterion. Ignore the letters indicating the Namur error category.
 - ↳ Follow the troubleshooting instructions provided in the last column of the error tables.
3. If the measured values are implausible, the local display is faulty or you encounter other problems, search for the faults under "Process errors without messages" (→ Operating Instructions Memosens, BA01245C) or "Device-specific errors" ().
 - ↳ Follow the recommended measures.
4. Contact the Service Department if you cannot rectify the error yourself, citing only the error number.

11.1.2 Process errors without messages

 Operating Instructions "Memosens", BA01245C

11.1.3 Device-specific errors

Problem	Possible cause	Tests and/or remedial measures
Dark display	No supply voltage	▶ Check if supply voltage applied.
	Base module defective	▶ Replace base module
Values appear on display but: ■ Display does not change and/or ■ Device cannot be operated	Module not wired correctly	▶ Check modules and wiring.
	Impermissible operating system condition	▶ Switch off device and switch it on again.
Implausible measured values	Inputs defective	▶ First perform tests and take measures as outlined in "Process-specific errors" section. Measuring input test: ▶ Connect the Memocheck Sim CYP03D to the input and use it to check the function of the input.
Controller signals not accepted or outputs do not switch	Incorrect program setting	▶ Check program setting
	Incorrect wiring	▶ Check wiring
	Electronics failure	▶ Replace base module

Problem	Possible cause	Tests and/or remedial measures
Sample not representative	Siphon in sampling hose	▶ Check the sampling hose
	Connection not tight/ sampling hose drawing in air	1. Check hoses/connections 2. Check routing of the sampling hose
	Bottles not filling correctly	Incorrect distribution selected in operation ▶ Calibrate the distribution arm
	Distribution arm stops	Incorrect distribution selected in operation 1. Check the distribution arm connection 2. Distributor is defective, replace distributor or arrange for repair by E+H Service
	Incorrect bottle filled	Incorrect distribution selected in operation
	No sample cooling	▶ Check the setting for the sample compartment temperature at the console Refrigeration system defective --> have repaired by E+H Service
	Incorrect pump tubing	▶ Only use the original pump tubing
	Sensory mechanism is faulty	▶ Replace the sensory mechanism (contact E+H Service)
No sampling	Connection not tight	▶ Check tightness of hoses/connections
	Sampling hose drawing in air	▶ Check routing of the sampling hose
	Air manager defective	Have repaired by E+H Service
	Vacuum pump defective	Have repaired by E+H Service
	Incorrect pump tubing	▶ Only use the original pump tubing
	Sensory mechanism is faulty	▶ Replace the sensory mechanism (contact E+H Service)
Current output, incorrect current value	Incorrect adjustment	▶ Check with integrated current simulation, connect mA meter directly to current output.
	Load too large	
	Shunt/short to ground in current loop	
No current output signal	Base module defective	▶ Check with integrated current simulation, connect mA meter directly to current output.

11.2 Diagnostic information on local display

Up-to-date diagnostic events are displayed along with their status category, diagnostic code and short text. Clicking on the navigator lets you retrieve more information and tips on remedial measures.

11.3 Adapting the diagnostic information

11.3.1 Classification of diagnostics messages

In the **DIAG/Diagnostics list** menu you can find more detailed information on the current diagnostic messages displayed.

In accordance with Namur specification NE 107, the diagnostic messages are characterized by:

- Message number
- Error category (letter in front of the message number)
 - **F** = (Failure) a malfunction has been detected
The cause of the malfunction is to be found in the sampling point/measuring point. Any control system connected should be set to manual mode.
 - **C** = (Function check), (no error)
Maintenance work is being performed on the device. Wait until the work has been completed.
 - **S** = (Out of specification), the measuring point is being operated outside its specification
Operation is still possible. However, you run the risk of increased wear, shorter operating life or lower measurement accuracy. The cause of the problem is to be found outside the measuring point.
 - **M** = (Maintenance required), action should be taken as soon as possible
The device still measures/takes samples correctly. Immediate measures are not necessary. However, proper maintenance efforts would prevent a possible malfunction in the future.
- Message text

 If you contact the Service Department, please cite the message number only. Since you can individually change the assignment of an error to an error category, the Service Department cannot use this information.

11.3.2 Adapting the diagnostic behavior

All the diagnostic messages are assigned to specific error categories at the factory. Since other settings might be preferred depending on the application, error categories and the effect errors have on the measuring point can be configured individually. Furthermore, every diagnostic message can be disabled.

Example

Diagnostic message 531 **Logbook full** appears on the display. You want to change this message so that an error is not shown on the display for example.

1. Select the diagnostics message and press the navigator button.
2. Decide: (a) Should the message be deactivated? (**Diagnostics message = Off**)
(b) Do you want to change the error category? (**Status signal**)
(c) Should an error current be output? (**Failure current = On**)
(d) Do you want to trigger a cleaning program? (**Cleaning program**)
3. Example: You deactivate the message.
 - ↳ The message is no longer displayed. In the **DIAG** menu, the message appears as **Past message**.

Possible settings

The list of diagnostic messages displayed depends on the path selected. There are device-specific messages, and messages that depend on what sensor is connected.

Menu/Setup/Run the ../Extended setup/Diagnostics settings/Diag. behavior		
Function	Options	Info
List of diagnostic messages		<ul style="list-style-type: none"> ▶ Select the message to be changed. Only then can you make the settings for this message.
Diag. code	Read only	

Menu/Setup/Run the ../Extended setup/Diagnostics settings/Diag. behavior		
Function	Options	Info
Diagnostic message	Selection <ul style="list-style-type: none"> ▪ Off ▪ On Factory setting Depends on the Diag. code	You can deactivate or reactivate a diagnostic message here. Deactivating means: <ul style="list-style-type: none"> ▪ No error message in the measuring mode ▪ No error current at the current output
Failure current	Selection <ul style="list-style-type: none"> ▪ Off ▪ On Factory setting Depends on the Diag. code	Decide whether an error current should be output at the current output if the diagnostic message display is activated. In the event of general device errors, the error current is switched to all the current outputs. In the event of channel-specific errors, the error current is only switched to the current output in question.
Status signal	Selection <ul style="list-style-type: none"> ▪ Maintenance (M) ▪ Out of specification (S) ▪ Function check (C) ▪ Failure (F) Factory setting Depends on the Diag. code	The messages are divided into different error categories in accordance with NAMUR NE 107. Decide whether you want to change a status signal assignment for your application.
Diag. output	Selection <ul style="list-style-type: none"> ▪ None ▪ Binary outputs ▪ Alarm relay ▪ Relay Factory setting None	You can use this function to select a relay output to which the diagnostic message should be assigned.  An alarm relay is always available, regardless of the device version. Other relays are optional. Before you can assign the message to an output: Configure one of the output types mentioned as follows: Menu/Setup/Outputs/(Alarm relay or Binary output or relay)/Function = Diagnostics and Operating mode = as assigned.
Cleaning program	Selection <ul style="list-style-type: none"> ▪ None ▪ Cleaning 1 ... 4 Factory setting None	Decide whether the diagnostic message should trigger a cleaning program. You can define cleaning programs under: Menu/Setup/Additional functions/Cleaning.
► Detail information	Read only	Here you can find more information on the diagnostic message and instructions on how to resolve the problem.

11.4 Overview of diagnostic information

11.4.1 Device-specific, general diagnostic messages

No.	Message	Factory settings			Tests or remedial action
		S ¹⁾	D ²⁾	F ³⁾	
202	Selftest active	F	On	Off	Wait for self-test to be finished
216	Hold active	C	On	Off	Output values and status of the channel are on hold

No.	Message	Factory settings			Tests or remedial action
		S ¹⁾	D ²⁾	F ³⁾	
241	Firmware failure	F	On	On	Internal device error
242	Firmware incomp.	F	On	On	1. Update the software.
243	Firmware failure	F	On	On	2. Contact the Service Department. 3. Replace the backplane (Service).
261	Electronics module	F	On	On	Electronics module defective 1. Replace the module. 2. Contact the Service Department.
262	Module connection	F	On	On	Electronics module not communicating 1. Check the cable connection , replace it if necessary. 2. Check the power supply of the sampling control module. 3. Contact the Service Department.
263	Incomp. detected	F	On	On	Wrong kind of electronics module 1. Replace the module. 2. Contact the Service Department.
284	Firmware update	M	On	Off	Update completed successfully
285	Update error	F	On	On	Firmware update failed 1. Repeat. 2. SD card error → use another card. 3. Incorrect firmware → repeat with suitable firmware. 4. Contact the Service Department.
302	Battery low	M	On	Off	Buffer battery of real time clock is low The date and time are lost if the power is interrupted. ► Contact the Service Department (battery replacement).
304	Module data	F	On	On	At least 1 module has incorrect configuration data 1. Check the system information. 2. Contact the Service Department.
305	Power consumption	F	On	On	Total power consumption too high 1. Check installation. 2. Remove sensors/modules.
306	Software error	F	On	On	Internal firmware error ► Contact the Service Department.
314	No sample flow	F	On	On	A vacuum cannot be generated in the peristaltic pump. 1. Check the pump hose for leaks. 2. Immerse the suction line in the medium.
322	Read sub-program	F	On	On	Selected subprogram cannot be read from the program memory ► Create a new subprogram.
323	Write sub-program	F	On	On	Subprogram created cannot be saved 1. Hardware error 2. Contact the Service Department.

No.	Message	Factory settings			Tests or remedial action
		S ¹⁾	D ²⁾	F ³⁾	
324	Delete sub-program	F	On	On	Selected subprogram cannot be deleted from the program memory ▶ Perform a software reset.
325	Read subprogram list	F	On	On	Subprogram list cannot be read from the program memory ▶ Perform a software reset.
328	Distribution arm	F	On	On	Distribution arm zero point not found during reference run 1. Perform the distribution arm test under Menu/Diagnostics/System test/Distribution arm. 2. Contact the Service Department.
331	Peristaltic pump	F	On	On	■ Peristaltic pump defective ■ Motor cable broken ▶ Contact the Service Department.
332	Peristaltic pump	F	On	On	Control of peristaltic pump defective ▶ Contact the Service Department.
333	Pressure sensor	F	On	On	Medium detection not possible, sampling not possible ■ Suction line not drained before sampling ■ Pressure sensor defective 1. Check the suction line, if necessary use the pump test under Menu/Diagnostics/System test/Pump purge. 2. Contact the Service Department.
337	Pump hose warning	M	On	Off	End of pump hose service life will be reached shortly Display under Menu/Diagnostics/Operating time information/Pump tube life 1. Schedule replacement. 2. After replacing, reset the operating time under Menu/Diagnostics/Operating time information.
338	Pump hose alarm	M	On	Off	End of pump hose service life reached Display under Menu/Diagnostics/Operating time information/Pump tube life. 1. Replace the pump hose. 2. After replacing, reset the operating time under Menu/Diagnostics/Operating time information.
343	Power supply	M	On	Off	Power supply failure
344	Program pause	C	On	Off	Sampling program paused
345	Time changeover	M	On	Off	Daylight saving time/winter time setting Normal time (winter time) active
346	Time changeover	M	On	Off	Daylight saving time/winter time setting Daylight saving time active
347	No sample confirm.	F	On	On	Sampling command has not been processed 1. Check the internal cable to 11F. 2. Perform a software reset.
348	Read program	F	On	On	Selected program cannot be read from the program memory ▶ Create a new program.

No.	Message	Factory settings			Tests or remedial action
		S ¹⁾	D ²⁾	F ³⁾	
349	Read program	F	On	On	Program created cannot be saved Hardware error has occurred ▶ Contact the Service Department.
351	Delete program	F	On	On	Selected program cannot be deleted from the program memory ▶ Perform a software reset.
352	Read Programlist	F	On	On	Program list cannot be read from the program memory ▶ Reset the device: Menu/Diagnostics/Device restart
353	Overfill check	F	On	Off	Total capacity of bottle reached No further sampling to current bottle is triggered ▶ If desired: Make changes to the sampling program under Select sampling program .
354	Bottle check	F	On	Off	No empty bottles available for current program No further sampling ▶ Check program settings under Select sampling program .
355	Start time over	M	On	Off	Start time entered is in the past ▶ Enter a new start time.
356	Overfill check	F	On	Off	The total sample volume does not fit in the sample bottle ▶ Change the sample volume.
357	Sampling faulted	M	On	Off	<ul style="list-style-type: none"> ▪ Sample discarded ▪ There are too many sampling requests pending ▶ Make changes to the sampling program under: Select sampling program .
358	Configuration	F	On	On	Program configuration does not match the current device configuration ▶ Adjust the configuration.
359	Emptying error	F	On	On	<ul style="list-style-type: none"> ▪ Error during emptying ▪ Emptying and sampling program is canceled 1. Check the connection to the FMSY1 module. 2. Check the 4R module, replace it if necessary. 3. Reset the device: Menu/Diagnostics/Device restart
366	Module connection	F	On	On	No communication with the actuator module ▶ Check the internal connecting cable to the 11F module.
370	Internal voltage	F	On	On	Internal voltage outside the valid range 1. Check supply voltage. 2. Check inputs and outputs for short-circuiting.
373	Electronic temp. high	M	On	Off	High electronics temperature ▶ Check ambient temperature and energy consumption.
374	Sensor check	F	On	Off	No measurement signal from sensor 1. Check sensor connection. 2. Check the sensor, replace it if necessary.

No.	Message	Factory settings			Tests or remedial action
		S ¹⁾	D ²⁾	F ³⁾	
401	Factory reset	F	On	On	Factory reset is performed
403	Device verification	M	Off	Off	Device verification active, please wait
405	Service IP active	C	Off	Off	Service switch is switched on The device can be addressed at 192.168.1.212. ► Switch off the service switch to change to the saved IP settings.
412	Writing backup	F	On	Off	► Wait for the write process to be finished
413	Reading backup	F	On	Off	► Wait.
436	SD card (80%)	M	On	Off	SD card 80% full 1. Replace SD card with empty card. 2. Clear SD card. 3. Set logbook properties to circular buffer (Setup/General settings/Logbooks).
437	SD card (100%)	M	On	Off	SD card 100% full. No longer possible to write to the card. 1. Replace SD card with empty card. 2. Clear SD card. 3. Set logbook properties to circular buffer (Setup/General settings/Logbooks).
438	SD card removed	M	On	Off	SD card not plugged in 1. Check SD card. 2. Replace SD card. 3. Disable logging.
455	Mathemat. function	F	On	On	Mathematical function: fault condition 1. Check mathematical function. 2. Check assigned input variables.
460	Output below limit	S	On	Off	Reasons ■ Sensor in air ■ Air pockets in assembly ■ Sensor fouled ■ Incorrect flow to sensor 1. Check sensor installation. 2. Clean sensor. 3. Change assignment of current outputs.
461	Output above limit	S	On	Off	
502	No text catalog	F	On	On	► Contact the Service Department.
503	Language change	M	On	Off	Language change failed ► Contact the Service Department.
529	Diag. setup active	C	Off	Off	► Wait for maintenance to be finished.
530	Logbook at 80%	M	On	Off	1. Save the logbook to the SD card and then delete the logbook in the device. 2. Set memory to circular buffer. 3. Deactivate logbook.
531	Logbook full	M	On	Off	
532	License error	M	On	Off	► Contact the Service Department.
540	Parameter save fail	M	On	Off	Storage of configuration has failed ► Repeat.
541	Parameter load ok	M	On	Off	Configuration successfully loaded

No.	Message	Factory settings			Tests or remedial action
		S ¹⁾	D ²⁾	F ³⁾	
542	Parameter load fail	M	On	Off	Loading of configuration has failed ▶ Repeat.
543	Parameter load abort	M	On	Off	Configuration loading aborted
544	Parameter reset ok	M	On	Off	Factory default successful
545	Parameter reset fail	M	On	Off	Setting of device configuration to factory setting has failed
903	Minimum flow	F	On	On	The flow is too low for flow-proportional sampling 1. Check the medium flow. 2. Check the flowmeter. 3. Check the configuration under Setup/Inputs/Current input S:x .
906	Cat.exchanger failure	F	On	Off	Invalid values for conductivity or flow 1. Check for valid measured values in the menu of the mathematical function. 2. Check sensors. 3. Check minimum flow.
907	Cat.exchanger warning	S	On	Off	Limit values exceeded for conductivity or flow. Possible reasons: ▪ Resin depleted ▪ Blocked pipe ▶ Check application.
908	IEX capacity low	M	On	Off	The capacity of the exchange resin will soon be exhausted. ▶ Schedule resin regeneration or replacement.
909	IEX capacity exhausted	F	On	Off	The capacity of the exchange resin is exhausted. ▶ Regenerate or replace the resin.
910	Limit switch	S	On	Off	Limit switch activated
920	No sample	F	On	On	No inflow during dosing process ▪ Suction line blocked or leaking ▪ No inflow of sample 1. Check suction line and suction strainer 2. Check inflow of sample.
921	Pump bracket open	F	On	On	The pump bracket is detected as open ▪ Pump bracket open ▪ Reed contact defective 1. Close the pump bracket. 2. Contact the Service Department.
930	No sample	F	On	On	Sample flow interrupted during aspiration ▪ Suction line blocked or leaking ▪ No inflow of sample 1. Check the suction line and suction strainer. 2. Check inflow of sample.
937	Controlled variable	S	On	Off	Controller input warning Status of the controller variable is not OK ▶ Check application.
938	Controller setpoint	S	On	Off	Controller input warning Status of set point is not OK ▶ Check application.

No.	Message	Factory settings			Tests or remedial action
		S ¹⁾	D ²⁾	F ³⁾	
939	Control. disturbance	S	On	Off	Controller input warning Status of disturbance variable is not OK ► Check application.
951 - 958	Hold active CH1 ..	C	On	Off	Output values and status of the channels are on hold. ► Wait until the hold is deactivated again.
961 - 968	Diagnostic module 1 (961) ... Diagnostic module 8 (968)	S	Off	Off	Diagnostic module is enabled
969	Modbus Watchdog	S	Off	Off	The device did not receive a Modbus telegram from the master within the specified time. The status of Modbus process values received is set to invalid
970	Curr. input overload	S	On	On	Current input overloaded The current input is switched off from 23 mA due to overload and reactivated automatically when a normal load is present.
971	Current Input low	S	On	On	Current input too low At 4 to 20 mA, the input current is less than the lower failure current. ► Check the input for short-circuiting.
972	Curr. input > 20 mA	S	On	On	Current output range exceeded
973	Current Input < 4 mA	S	On	On	Current output range undershot
974	Diagnostics confirm.	C	Off	Off	User has acknowledged the message displayed in the measuring menu.
975	Device restart	C	Off	Off	Device reset
978	ChemoClean Failsafe	S	On	On	No feedback signal detected within the configured period. 1. Check application. 2. Check wiring. 3. Extend the duration.
990	Deviation limit	F	On	On	Redundancy: limit value of percentage deviation exceeded
991	CO ₂ conc. range	F	On	On	CO ₂ concentration (degassed conductivity) outside the measuring range
992	pH calculation range	F	On	On	pH calculation outside the measuring range
993	rH calculation range	F	On	On	rH calculation outside the measuring range
994	Difference conduct.	F	On	On	Dual conductivity outside the measuring range

- 1) **Status signal**
2) **Diagnostic message**
3) **Failure current**

11.4.2 Sensor-specific diagnostics messages

 Operating Instructions "Memosens", BA01245C

11.5 Pending diagnostic messages

The Diagnostics menu contains all the information on the device status.

Furthermore, various service functions are available.

The following messages are directly displayed every time you enter the menu:

- **Most important message**

Diagnostic message recorded with the highest criticality level

- **Past message**

Diagnostic message whose cause is no longer present.

All the other functions in the Diagnostics menu are described in the following chapters.

Diagnostic messages associated with sampling are deleted under the following conditions:

- Diagnostic messages caused by sampling are deleted automatically with the next successful sampling.
- Diagnostic messages caused by the level of medium in the bottle are deleted the next time the bottle is changed.

 If the diagnostic message "M313 liquid sensor" appears 5 times in succession when executing a program, the active program is aborted for reasons of safety. This behavior on the part of the device cannot be altered by deactivating the diagnostic message under **Menu/Setup/General settings/Extended setup/Diagnostics settings** .

11.6 Diagnosis list

All the current diagnostic messages are listed here.

A time stamp is available for each message. Furthermore, the user also sees the configuration and description of the message as saved in **Menu/Setup/General settings/Extended setup/Diagnostics settings/Diag. behavior** .

11.7 Logbooks

11.7.1 Available logbooks

Types of logbooks

- Logbooks physically available (all apart from the overall logbook)
- Database view of all logbooks (=overall logbook)

Logbook	Visible in	Max. entries	Can be disabled ¹⁾	Logbook can be deleted	Entries can be deleted	Can be exported
Overall logbook	All events	20000	Yes	No	Yes	No
Calibration logbook	Calibration events	75	(Yes)	No	Yes	Yes
Operation logbook	Configuration events	250	(Yes)	No	Yes	Yes
Diagnostics logbook	Diagnostic events	250	(Yes)	No	Yes	Yes
Program log	Program logbook	5000	Yes	No	Yes	Yes
Version logbook	All events	50	No	No	No	Yes
Hardware version logbook	All events	125	No	No	No	Yes

Logbook	Visible in	Max. entries	Can be disabled ¹⁾	Logbook can be deleted	Entries can be deleted	Can be exported
Data logbook for sensors (optional)	Data logbooks	150 000	Yes	Yes	Yes	Yes
Debugging logbook	Debug events (only accessible by entering the special service activation code)	1000	Yes	No	Yes	Yes

1) Data in brackets means this depends on the overall logbook

11.7.2 Logbooks menu

DIAG/Logbooks		
Function	Options	Info
▶ All events		Chronological list of all the logbook entries, with information on the type of event
▶ Show	Events are displayed	Select a particular event to display more detailed information.
▶ Go to date	User entry <ul style="list-style-type: none"> ▪ Go to date ▪ Time 	Use this function to go directly to a specific time in the list. In this way, you avoid having to scroll through all the information. The complete list is always visible, however.
▶ Calibration events		Chronological list of the calibration events
▶ Show	Events are displayed	Select a particular event to display more detailed information.
▶ Go to date	User entry <ul style="list-style-type: none"> ▪ Go to date ▪ Time 	Use this function to go directly to a specific time in the list. In this way, you avoid having to scroll through all the information. The complete list is always visible, however.
▷ Delete all entries	Action	You can delete all the calibration logbook entries here.
▶ Configuration events		Chronological list of the configuration events
▶ Show	Events are displayed	Select a particular event to display more detailed information.
▶ Go to date	User entry <ul style="list-style-type: none"> ▪ Go to date ▪ Time 	Use this function to go directly to a specific time in the list. In this way, you avoid having to scroll through all the information. The complete list is always visible, however.
▷ Delete all entries	Action	You can use this to delete all the operation logbook entries.
▶ Diagnostic events		Chronological list of the diagnostics events
▶ Show	Events are displayed	Select a particular event to display more detailed information.
▶ Go to date	User entry <ul style="list-style-type: none"> ▪ Go to date ▪ Time 	Use this function to go directly to a specific time in the list. In this way, you avoid having to scroll through all the information. The complete list is always visible, however.
▷ Delete all entries	Action	You can use this to delete all the diagnostics logbook entries.

You can view your data logbook entries graphically on the display (**Show plot**).

You can also adapt the display to suit your individual requirements:

- Press the navigator button in the graphic display: you are given additional options such as the zoom function and x/y movement of the graph.
- Define the cursor: if you select this option, you can move along the graph with the navigator and view the logbook entry (data stamp/measured value) in text form for every point in the graph.
- Simultaneous display of two logbooks: **Select 2nd plot** and **Show plot**
 - A small cross marks the currently selected graph for which the zoom can be changed or a cursor used, for example.
 - In the context menu (press the navigator button), you can select the other graph. You can then apply the zoom function, a movement or a cursor to this graph.
 - Using the context menu, you can also select both graphs simultaneously. This enables you to use the zoom function on both graphs simultaneously, for example.

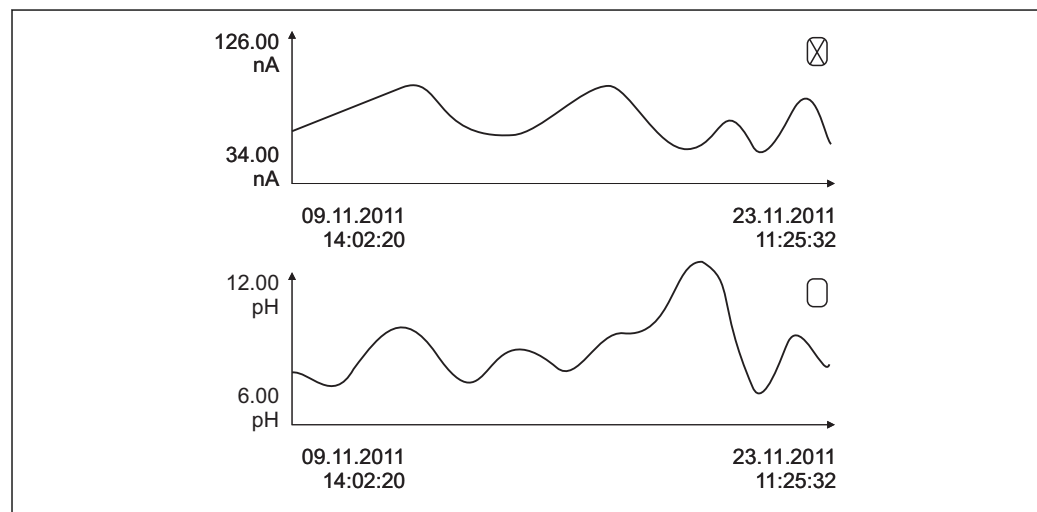

A0016688

14 Simultaneous display of two graphs, the top one is "selected"

DIAG/Logbooks		
Function	Options	Info
► Data logbooks		Chronological list of the data logbook entries for sensors
Data logbook 1 ... 8 <Logbook name>		This submenu is available for each data logbook that you have set up and activated.
Source of data	Read only	Input or mathematical function is displayed
Measured value	Read only	Measured value being recorded is displayed
Log time left	Read only	Display of days, hours and minutes until logbook is full. ► Pay attention to the information on selecting the memory type in the General settings/Logbooks menu.
► Show	Events are displayed	Select a particular event to display more detailed information.
► Go to date	User entry <ul style="list-style-type: none"> ■ Go to date ■ Time 	Use this function to go directly to a specific time in the list. In this way, you avoid having to scroll through all the information. The complete list is always visible, however.
► Show plot	Graphic display of the logbook entries	The entries are displayed according to your settings in the General settings/Logbooks .
Select 2nd plot	Select another data logbook	You can view a second logbook at the same time as the current one.

DIAG/Logbooks		
Function	Options	Info
▷ Delete all entries	Action	You can use this to delete all data logbook entries.
▶ Save logbooks		
File format	Selection <ul style="list-style-type: none"> ▪ CSV ▪ FDM 	<ul style="list-style-type: none"> ▶ Save the logbook in the preferred file format. You can then open the saved CSV file on the PC in MS Excel, for example, and make further edits here. ¹⁾ You can import the FDM files into FieldCare and archive them so that they are tamper-proof.
▷ All data logbooks ▷ Data logbook 1 ... 8 ▷ All event logbooks ▷ Calibration logbook ▷ Diagnostic logbook ▷ Configuration logbook ▷ HW version logbook ▷ Version logbook	Action, commences as soon as the option is selected	The logbooks are read out via the CDI interface.
 The file name consists of Logbook ident (Menu/Setup/General settings/Logbooks) , an abbreviation for the logbook and a time stamp.		

- 1) CSV files use international number formats and separators. Therefore they must be imported into MS Excel as external data with the correct format settings. If you double-click the file to open it, the data are only displayed correctly if MS Excel is installed with the US country setting.

11.7.3 Program logbook

Entry	Example	Info
Timestamp	05.05.2010 12:40	Time stamp - the start time in the case of sampling
Event	BasicPrgStart	Power on --> Time the device is started Power failure --> Time the power failed (to the minute) BasicPrgStart, StdPrgStart --> Time the program was started BasicSampling, StdSampling --> Entry made during sampling PrgPartStart, PrgPartStop --> Time a subprogram is enabled and disabled PrgStop --> Time the program was ended
Name	Program1	In the case of BasicPrgStart, StdPrgStart, BasicSampling or PrgStop --> The name of the program appears In the case of StdSampling, PrgPartStart or PrgPartStop --> The name of the subprogram appears
Bottle configuration	12x+6x - PE/glass plate distribution	The selected bottle configuration is displayed
Left bottle volume	1000	The bottle volume is displayed
Right bottle volume	3000	--> "Right bottle volume" remains empty for bottle configurations with different volumes

Entry	Example	Info
Sampling mode	Time-paced CTCV	Time-paced CTCV Time-paced Flow-paced VTCV Flow-paced Time/flow-paced CTVV Time/flow-paced Single sample Single sample Sample table Single sample Sampling mode Display of the sampling mode
Sampling interval/unit	10 min	Display of the interval and the unit
Samples/bottle	4	With bottle change Number of samples per bottle .
Bottles/sample	0	Multiple bottles,
Sampling volume/unit	100 ml	Sample volume when sampling
Start mode	Immediate	Field only populated for PrgPartStart , BasicPrgStart and StdPrgStart : --> The program start setting is displayed <ul style="list-style-type: none"> ▪ Immediate --> immediately ▪ Date/time --> after date/time ▪ Volume --> with a volume ▪ Event --> when an event occurs ▪ Interval --> after an interval ▪ Individual dates --> individual timetable ▪ Multiple date --> multiple dates
Start date	05.05.2010	Field only populated if Start mode = Date/Time : --> The start date is displayed
Stop mode	Program end	The program stop setting is displayed: <ul style="list-style-type: none"> ▪ Program end --> when the program ends ▪ Continuous --> continuous operation ▪ Bottles full --> when bottles are full ▪ Date/time --> after date/time ▪ Event --> when an event occurs
Stop date	06.05.2010	Field only populated if Program end = Date/Time : --> The date the program was stopped is displayed
Start flow sum/unit	100 m ³	Field only populated if Start mode = Volume : --> The starting volume is displayed
Bottle number	1	Field only populated for BasicSampling or StdSampling : --> The bottle which was filled with the sample is displayed
Sample nbr	2	Number of samples transferred to the current bottle
Sampling result	Sampling Ok	Sampling Ok --> sampling ok Sampling nOk --> sampling failed --> For detailed diagnostics messages, see the diagnostics logbook

Entry	Example	Info
Running sample number	1	Running sample number in the current program
Flow sum since last sampling	1	For flow-paced and time/flow-paced sampling: --> Flow since the last sampling For all other types of sampling: --> Display: 0

11.7.4 Bottle statistics

The bottle statistics of the sampler are displayed:

- ▶ In **Menu/Diagnostics/Logbooks/Logbook program** select the menu item **Show summary of current program** , or simply select the STAT soft key while the sampling program is running
 - ↳ The statistics are displayed for each individual bottle when the program is started. This gives you detailed feedback on the last sampling operations.

 The statistics are deleted when the following event occurs:
Program is started

The statistics are selectively overwritten when the following event occurs:
When the first bottle is reached in situations where "Continuous operation" is configured as the end of the program in the program settings

The statistics are displayed as follows:

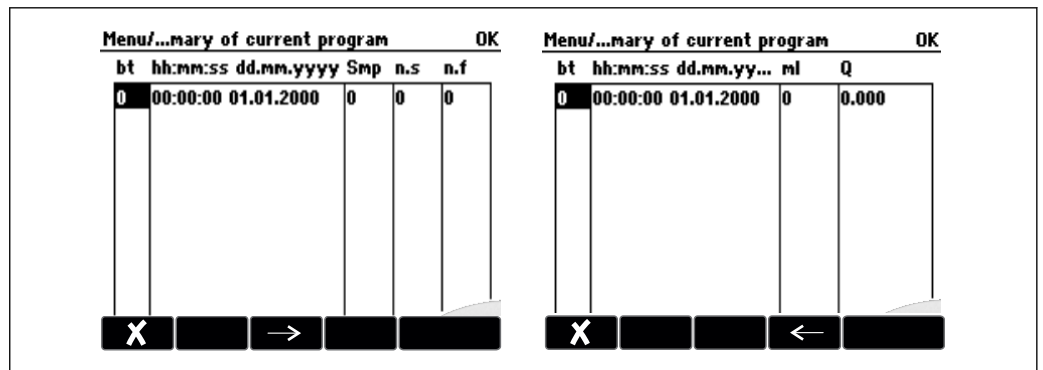

A0036867-EN

User interface	Info
bt	The bottle number is displayed.
hh:mm	The time the first sample was transferred to the bottle is displayed.
DD-hh:mm	The time the first sample was transferred to the bottle is displayed.
Smp	Displays how often sampling was triggered per bottle.
n.s	Indicates the number of times a sample was not taken even though sampling was triggered. This can occur if the maximum permissible fill volume for the bottle has been reached but the system is still supposed to transfer samples to the bottle. The "Overfill sensor" message is displayed while the program is active.
n.f	The value indicates how often sampling was canceled since the system was unable to take in any medium, or enough medium, into the dosing chamber to cover the LF1 probe.
ml	The sampling volume collected per bottle is displayed.
Q	The total flow for every bottle is displayed (if connected).

11.8 Device information

11.8.1 System information

DIAG/System information		
Function	Options	Info
Device tag	Read only	Individual device tag → General settings
Order code	Read only	You can order identical hardware with this code. This code changes on account of changes to the hardware and you can enter the new code you received from the manufacturer here ¹⁾ .
 To establish the version of your device, enter the order code into the search screen at the following address: www.endress.com/order-ident		
Orig. order code ext.	Read only	Complete order code for the original device, resulting from the product structure.
Current order code ext.	Read only	Current code, taking into account changes to the hardware. You must enter this code yourself.
Serial number	Read only	The serial number allows you to access device data and documentation on the Internet: www.endress.com/device-viewer
Software version	Read only	Current version
Sw version FMSY1	Read only	Current version
FMSY1 proj. version	Read only	Current version
▶ SD card	Read only <ul style="list-style-type: none"> ■ Total ■ Free memory 	
▶ System modules		
Backplane	Read only <ul style="list-style-type: none"> ■ Description ■ Serial number ■ Order code ■ Hardware version ■ Software version 	This information is provided for every electronics module available. Specify the serial numbers and order codes when servicing, for example.
Base		
Display module		
Extension module 1 ... 8		
▶ Sensors	Read only <ul style="list-style-type: none"> ■ Description ■ Serial number ■ Order code ■ Hardware version ■ Software version 	This information is provided for every sensor available. Specify the serial numbers and order codes when servicing, for example.
▶ Save system information		
▷ Save to SD card	File name assigned automatically (includes a time stamp)	The information is saved on the SD card in a "sysinfo" subfolder. The csv file can be read and edited in MS Excel, for example. This file can be used when servicing the device.

DIAG/System information		
Function	Options	Info
▶ Heartbeat operation		Heartbeat functions are only available with the appropriate device version or optional access code.
▶ Device	Read only <ul style="list-style-type: none"> ▪ Total operating time ▪ Counters since reset <ul style="list-style-type: none"> ▪ Availability ▪ Operating time ▪ Time in failure ▪ Number of failures ▪ MTBF ▪ MTTR ▪ ▷ Reset counters 	Availability Percentage of time no error with the status signal F was pending $(\text{Operating time} - \text{Time in failure}) * 100\% / \text{Operating time}$ Time in failure Total amount of time an error with the status signal F was pending MTBF Mean Time Between Failures $(\text{Operating time} - \text{Time in failure}) / \text{Number of failures}$ MTTR Mean Time To Repair $\text{Time in failure} / \text{Number of failures}$

1) Provided you give the manufacturer all the information about changes to the hardware.

11.8.2 Sensor information

▶ Select the channel you want from the list of channels.

Information in the following categories is displayed:

- **Extreme values**

Extreme conditions to which the sensor was previously exposed, e. g. min./max. temperatures ²⁾

- **Operating time**

Operating time of the sensor under defined extreme conditions

- **Calibration information**

Calibration data of the last calibration

- **Sensor specifications**

Measuring range limits for main measured value and temperature

- **General information**

Information on sensor identification

The specific data that are displayed depends on what sensor is connected.

11.9 Simulation

You can simulate values at inputs and outputs for testing purposes:

- Current values at current outputs
- Measured values at inputs
- Relay contact opening or closing



Only current values are simulated. Via the simulation function, it is not possible to calculate the totalized value for the flow or rainfall.



▶ Before simulation: Enable the inputs and outputs in the Setup menu.

2) Not available for all sensor types.

DIAG/Simulation		
Function	Options	Info
▶ Current output x:y		Simulation of an output current This menu appears once for each current output.
Simulation	Selection <ul style="list-style-type: none"> ▪ Off ▪ On Factory setting Off	If you simulate the value at the current output, this is indicated on the display by a simulation icon in front of the current value.
Current	2.4 to 23.0 mA Factory setting 4 mA	▶ Set the desired simulation value.
▶ Alarm relay ▶ Relay x:y		Simulation of a relay state This menu appears once for each relay.
Simulation	Selection <ul style="list-style-type: none"> ▪ Off ▪ On Factory setting Off	If you simulate the relay state, this is indicated on the display by a simulation icon in front of the relay display.
State	Selection <ul style="list-style-type: none"> ▪ Low ▪ High Factory setting Low	▶ Set the desired simulation value. The relay switches in accordance with your setting when you switch on the simulation. In the measured value display you see On (= Low) or Off (= High) for the simulated relay state.
▶ Meas. inputs		Simulation of a measured value (only for sensors)
Channel : parameter		This menu appears once for each measuring input.
Simulation	Selection <ul style="list-style-type: none"> ▪ Off ▪ On Factory setting Off	If you simulate the measured value, this is indicated on the display by a simulation icon in front of the measured value.
Main value	Depends on the sensor	▶ Set the desired simulation value.
Sim. temperature	Selection <ul style="list-style-type: none"> ▪ Off ▪ On Factory setting Off	If you simulate the temperature measured value, this is indicated on the display by a simulation icon in front of the temperature.
Temperature	-50.0 to +250.0 °C (-58.0 to 482.0 °F) Factory setting 20.0 °C (68.0 °F)	▶ Set the desired simulation value.

11.10 Device test

Menu/Diagnostics/System test		
Function	Options	Info
▶ Manual sampling		
Bottle configuration	Read only	
Bottle configuration	Read only	
Bottle configuration	Selection <ul style="list-style-type: none"> ▪ Front ▪ Bottle 1 ... ▪ Back 	Select which bottle should be filled with the sample.
Sample volume	50 to 2000 ml 10 to 10000 ml Factory setting 100 ml	You can change the sample volume in the version with the peristaltic pump. The sample volume can be changed.
Sample volume	Factory setting 200 ml	The sample volume is preset at the factory in the version with the vacuum pump.
▷ Start sampling	Action	
▶ Peristaltic pump		
▷ Pump purge	Action	
Pump purge, to stop press ESC	Read only	
Current pump operating time	Read only	
Power supply	Read only	The current supply voltage is displayed. With AC power supply: 24 V ±0.5 V With DC power supply: 22 to 28 V
Motor current	Read only	The current consumption of the pump is displayed.
Vacuum	Read only	The vacuum is an indicator of the suction height. -> 100 mbar corresponds to approx. 1 m suction height
Medium detected	Read only	Yes: the medium was detected No: no medium was detected
▷ Pump suction	Action	
Pump suction, to stop press ESC	Read only	
Current pump operating time	Read only	
Power supply	Read only	The current supply voltage is displayed. With AC power supply: 24 V ±0.5 V With DC power supply: 22 to 28 V
Motor current	Read only	The current consumption of the pump is displayed.
Vacuum	Read only	The vacuum is an indicator of the suction height. -> 100 mbar corresponds to approx. 1 m suction height
Medium detected	Read only	Yes: the medium was detected No: no medium was detected
▷ Vacuum pump (only for version with vacuum pump)	Action	
Bottle configuration	Read only	

Menu/Diagnostics/System test		
Function	Options	Info
Bottle volume	Read only	
Distributor position	Selection <ul style="list-style-type: none"> ▪ Front ▪ Bottle 1 ... ▪ Back 	Select which bottle should be filled with the sample.
Sample volume	Factory setting 200 ml	The sample volume is preset at the factory.
▷ Start sampling	Action	Perform sampling manually.
Progress	Read only	The progress of the sampling operation is displayed.
Power supply	Read only	The current supply voltage is displayed. With AC power supply: 24 V ±0.5 V With DC power supply: 22 to 28 V
Motor current	Read only	The current consumption of the pump is displayed.
Medium LF1	Read only	<ul style="list-style-type: none"> ▪ Medium detection LF1 switchoff ▪ Medium detection LF2 disconnection from protective circuit -> Both "No" at the start -> If "Yes", clean LF2
Medium LF2	Read only	
▷ Inline sampling (only for version with sampling assembly)	Action	
Sampling activated, to stop press ESC	Read only	
Progress	Read only	
▷ Distribution arm	Action	Only for bottle configurations with more than one bottle.
Test distribution arm	Read only	When the menu item is activated, the distribution arm undergoes a test run. Afterwards, the system moves to each position in succession and the position is displayed. In the case of plate distribution, the arm moves left and right to ensure the bottles are numbered consecutively.  Calibrate the distribution arm if the arm is not positioned precisely over the bottles.
Position	Read only	
▶ Power supply	Read only <ul style="list-style-type: none"> ▪ Digital supply 1: 1.2V ▪ Digital supply 2: 3.3V ▪ Analog supply: 12.5V ▪ Sensor supply: 24V ▪ Temperature 	Detailed list of power supply to instrument.  The actual values can vary without a malfunction having occurred.

11.11 Resetting the measuring device

Menu/Diagnostics		
Function	Options	Info
▷ Device restart	Selection <ul style="list-style-type: none"> ▪ OK ▪ ESC 	Restart and keep all the settings
▷ Factory default	Selection <ul style="list-style-type: none"> ▪ OK ▪ ESC 	Restart with factory settings Settings that have not been saved are lost.

11.12 Information on operating times

The following information is displayed:

- **Operating hours device:**
Displays the total operating hours of the device in days, hours and minutes
- **Sample totalizer:**
Number of all samples taken and sample errors
- **Pump tube life** (for version with peristaltic pump):
Displays how old the tube is in days, hours and minutes
- **Peristaltic pump** (for version with peristaltic pump):
Displays the pump operating time in hours and minutes



This counter must be reset when a tube is replaced.

- **Filter mats:**
Displays the period of usage in days
- **Operating time photometer:**
Displays the hours of operation in hours

With **Reset** set the specific counter reading to zero.

11.13 Status of inputs/outputs

Path: **Display/Measurement**

The following measured values are listed (read only):

- **Binary inputs**
Current function state: on or off
- **Current inputs**
Actual current values of all the current inputs available
- **Binary outputs**
Current function state: on or off
- **Temperature sensors**
Current value is displayed
- **Current outputs**
(for version with sensors with the Memosens protocol) Actual current values of the current outputs

11.14 Firmware history

Date	Version	Changes to firmware	Documentation
05/2018	01.06.06	Improvement <ul style="list-style-type: none"> ▪ New soft keys ALL and NONE in multiple selection editors ▪ Manual factor for CAS51D nitrate ▪ Calibration timer and validity revised for pH, conductivity, oxygen and disinfection ▪ Clear distinction between offset and 1-point calibration for pH ▪ Heartbeat verification report can now also be downloaded via the web server ▪ Better description of diagnostics code 013 	BA00444C/07/EN/22.18
03/2016	01.06.00	Expansion <ul style="list-style-type: none"> ▪ "Ensure activation" switch with subprogram activation "Interval" ("Bavarian sampling") ▪ Binary input can switch sampling to the hold state Improvement <ul style="list-style-type: none"> ▪ Sensors can be calibrated while the program is running ▪ Incremental sampling moved after diagnostics/device test ▪ Dosing time for vacuum sampling can be adjusted ▪ Binary output can be switched after multiple samples have been taken ▪ Improved control over the activation/deactivation of subprograms via binary inputs ▪ Specification of "Volume per bottle" in the run screen ▪ Program can be started at a specific time ▪ Paused program can be restarted with new "Continue program" entry via MODE softkey ▪ Minimum sampling time and dosing time reduced to 1 s for Inline sampling 	BA00444C/07/EN/19.16 BA00486C/07/EN/02.13 BA01245C/07/EN/03.16
03/2015	01.05.02	Expansion <ul style="list-style-type: none"> ▪ Time exceeded with flow proportional sampling ▪ Outputs Improvement <ul style="list-style-type: none"> ▪ Menu corrections (functions, designations) ▪ Chemoclean Plus for samplers 	BA00443C/07/EN/19.15 BA01245C/07/EN/02.15
12/2013	01.05.00	Expansion <ul style="list-style-type: none"> ▪ Calendar function for cleaning ▪ Conductivity: <ul style="list-style-type: none"> ▪ Measuring range switching also for conductive conductivity measurement ▪ External temperature signal via current input ▪ Oxygen: <ul style="list-style-type: none"> ▪ External pressure or temperature signals via current input ▪ Connected conductivity sensor can be used to calculate the salinity ▪ Channel-specific diagnostics codes for HOLD function. 	BA0065C/07/EN/16.13 BA01245C/07/EN/01.13

Date	Version	Changes to firmware	Documentation
12/2013	01.05.00	<p>Expansion</p> <ul style="list-style-type: none"> ▪ Chemoclean Plus ▪ Calendar function for cleaning ▪ Conductivity: <ul style="list-style-type: none"> ▪ Measuring range switching also for conductive conductivity measurement ▪ External temperature signal via current input ▪ Oxygen: <ul style="list-style-type: none"> ▪ External pressure or temperature signals via current input ▪ Connected conductivity sensor can be used to calculate the salinity ▪ SAC, nitrate, turbidity: Calibration settings can be configured via fieldbus ▪ Channel-specific diagnostics codes for HOLD function. <p>Improvement</p> <ul style="list-style-type: none"> ▪ Web server login for managing multiple users ▪ Set point and PID parameters for controllers can be configured via fieldbus 	<p>BA00444C/07/EN/17.13 BA01225C/07/EN/02.13 BA00486C/07/EN/02.13 BA01245C/07/EN/01.13</p>
04/2013	01.04.00	<p>Expansion</p> <ul style="list-style-type: none"> ▪ Conductivity: <ul style="list-style-type: none"> ▪ Measuring range switching ▪ Temperature compensation ISO 7888 at 20 °C ▪ Keylock with password protection ▪ pH: <ul style="list-style-type: none"> ▪ Icon for manual and automatic temperature compensation (ATC/MTC+MED) ▪ Monitoring for the upper and lower limits of the glass SCS value can be switched on/off independently of each another ▪ ISE <ul style="list-style-type: none"> ▪ Simultaneous calibration of two parameters ▪ User-defined electrode type ▪ Raw measured values can be selected for current output ▪ Timer for membrane replacement ▪ Logbooks remain intact after the firmware update <p>Improvement</p> <ul style="list-style-type: none"> ▪ Offset icon only for pH or ORP ▪ Turbidity: autoranging can be switched off ▪ Export Print (xml): Export file revised and style sheet added for better legibility. ▪ Overview of input with counter function ▪ Input menu accessible via program creation ▪ External signal for basic programs ▪ Quick programming via start screen ▪ 	<p>BA00465C/07/EN/15.13 BA00470C/07/EN/15.13 BA00492C/07/EN/15.13 BA00493C/07/EN/15.13 SD01068C/07/EN/01.12</p>

Date	Version	Changes to firmware	Documentation
04/2013 07/2013	01.04.00	<p>Expansion</p> <ul style="list-style-type: none"> ▪ Conductivity: <ul style="list-style-type: none"> ▪ Measuring range switching ▪ Temperature compensation ISO 7888 at 20 °C ▪ Support for DIO module <ul style="list-style-type: none"> ▪ Triggering of external hold ▪ Triggering a cleaning ▪ Limit contactor signals via digital output ▪ Keylock with password protection ▪ PID controller: feedforward control is supported ▪ pH: <ul style="list-style-type: none"> ▪ Icon for manual and automatic temperature compensation (ATC/MTC+MED) ▪ Monitoring for the upper and lower limits of the glass SCS value can be switched on/off independently of each another ▪ ISE <ul style="list-style-type: none"> ▪ Simultaneous calibration of two parameters ▪ User-defined electrode type ▪ Raw measured values can be selected for current output ▪ Timer for membrane replacement ▪ Logbooks remain intact after the firmware update <p>Improvement</p> <ul style="list-style-type: none"> ▪ PROFIBUS address range for Siemens-S7 moved to the lower range. ▪ Offset icon only for pH or ORP ▪ Turbidity: autoranging can be switched off ▪ Export Print (xml): Export file revised and style sheet added for better legibility. <p>Original firmware</p>	<p>BA00444C/07/EN/16.13 BA01225C/07/EN/01.13 BA00445C/07/EN/16.13 BA01227C/07/EN/01.13 BA00450C/07/EN/16.13 BA00450C/07/EN/17.13 BA00451C/07/EN/15.13 BA00451C/07/EN/16.13 BA00486C/07/EN/01.11 BA00486C/07/EN/02.13</p>
06/2012	01.03.01	<p>Improvement</p> <ul style="list-style-type: none"> ▪ Hold via soft key ▪ Global or channel-specific hold stops automatic cleaning. However, manual cleaning can be started. ▪ Adapted factory settings 	<p>BA00444C/07/EN/15.12 BA00445C/07/EN/15.12 BA00450C/07/EN/15.12 BA00451C/07/EN/14.11 BA00486C/07/EN/01.11</p>
12/2011	01.03.00	<p>Expansion</p> <ul style="list-style-type: none"> ▪ Max. 8 sensor channels supported ▪ Current inputs ▪ PROFIBUS DP supported incl. Profile 3.02 ▪ Modbus RTU (RS485) supported ▪ Modbus TCP supported ▪ Integrated web server supported via TCP/IP (RJ45) ▪ USP/EP (United States Pharmacopeia and European Pharmacopeia) and TDS (Total Dissolved Solids) for conductivity ▪ Icon for "controller active" in measuring screen <p>Improvement</p> <ul style="list-style-type: none"> ▪ Controller hold via analog input ▪ Adapted factory settings ▪ SAC: factory calibration in the field incl. reset filter operation time and lamp change ▪ ISFET leak current visible in measuring screen ▪ Multiselect for limit switch and cleaning cycles 	<p>BA00444C/07/EN/14.11 BA00445C/07/EN/14.11 BA00450C/07/EN/14.11 BA00451C/07/EN/14.11 BA00486C/07/EN/01.11</p>

Date	Version	Changes to firmware	Documentation
12/2010	01.02.00	Expansion <ul style="list-style-type: none"> ▪ Support for additional sensors: <ul style="list-style-type: none"> ▪ Chlorine ▪ ISE ▪ SAC ▪ Interface ▪ HART Communication ▪ Mathematics functions Improvement <ul style="list-style-type: none"> ▪ Modified software structures ▪ Adapted factory settings ▪ User-defined measuring screens 	BA444C/07/EN/13.10 BA445C/07/EN/13.10 BA450C/07/EN/13.10 BA451C/07/EN/13.10 BA00486C/07/EN/01.11
03/2010	01.00.00	Original software	BA444C/07/EN/03.10 BA445C/07/EN/03.10 BA450C/07/EN/03.10 BA451C/07/EN/03.10
07/2012	01.03	Expansion <p>USP/EP (United States Pharmacopeia and European Pharmacopeia) and TDS (Total Dissolved Solids) for conductivity</p> Improvement <ul style="list-style-type: none"> ▪ Adapted factory settings ▪ SAC: factory calibration in the field incl. reset filter operation time and lamp change ▪ ISFET leak current visible in measuring screen ▪ Multiselect for limit switch and cleaning cycles 	BA00465C/07/EN/14.12 BA00470C/07/EN/14.12 BA00492C/07/EN/14.12 BA00493C/07/EN/14.12
04/2011	01.02	Expansion <ul style="list-style-type: none"> ▪ Support for additional sensors: <ul style="list-style-type: none"> ▪ Chlorine ▪ ISE ▪ SAC ▪ Interface ▪ Mathematics functions Improvement <ul style="list-style-type: none"> ▪ Modified software structures ▪ Adapted factory settings ▪ User-defined measuring screens 	BA465C/07/EN/13.11 BA470C/07/EN/13.11 BA492C/07/EN/13.11 BA493C/07/EN/13.11
06/2010	01.00	Original software	BA465C/07/EN/06.10 BA470C/07/EN/06.10 BA464C/07/EN/04.10 BA467C/07/EN/04.10

12 Maintenance

Effects on process and process control

- ▶ Take all the necessary precautions in time to ensure the operational safety and reliability of the entire measuring point.

WARNING

Process pressure and temperature, contamination, electrical voltage

Risk of serious or fatal injury

- ▶ If a sensor has to be removed during maintenance work, avoid hazards posed by pressure, temperature and contamination.
- ▶ Make sure the device is de-energized before you open it.
- ▶ Power can be supplied to switching contacts from separate circuits. De-energize these circuits before working on the terminals.

NOTICE

Electrostatic discharge (ESD)

Risk of damaging the electronic components

- ▶ Take personal protective measures to avoid ESD, such as discharging beforehand at PE or permanent grounding with a wrist strap.
- ▶ For your own safety, use only genuine spare parts. With genuine parts, the function, accuracy and reliability are also ensured after maintenance work.

CAUTION

Possibility of microbiological contamination of content of sample bottles.

Minor to medium injury possible.

- ▶ Wear suitable protective clothing.

12.1 Recommended maintenance

Maintenance work has to be carried out at regular intervals to ensure the efficient operation of the sampler.

The maintenance work comprises:

- Replacing the wear parts
- Cleaning the device

The cleaning intervals depend heavily on:

- The medium
- The ambient conditions of the sampler (dust etc.)
- The programming intervals

For this reason, adapt the cleaning intervals to your specific requirements but always ensure that these cleaning tasks are performed regularly.

Replacing wear parts

Wear parts are replaced by Endress+Hauser Service at one- and two-year intervals. Please contact your local sales center in this regard.

-  Endress+Hauser offers its customers a maintenance contract. A maintenance contract increases the operational safety of your device and reduces your staff's workload. Ask your Endress+Hauser Service Organization for detailed information on maintenance contracts.

12.2 Calibration

12.2.1 Sensors

- Sensors with Memosens protocol are calibrated at the factory.
- Users must decide whether the process conditions present require calibration during initial commissioning.
- Additional calibration is not required in many standard applications.
- Calibrate the sensors at sensible intervals depending on the process.

 Operating Instructions "Memosens", BA01245C

 All connected sensors can be calibrated while a sampling program is active.

12.2.2 Distribution arm

The position of the distribution arm is set at the factory. It is only possible to calibrate the distribution arm in the version with multiple bottles.

The distribution arm must be calibrated if:

- The distribution arm motor has been replaced
- Error message "F236 Distribution arm" appears on the display

1. In menu "**Setup/Basic setup**" select the number of bottles.
2. Proceed as follows to calibrate the distribution arm:

Menu/Calibration active		
Function	Options	Info
▶ Distribution arm		
▷ Go to ref. point	Action	The reference run is started. The reference point is in the middle at the front. For versions with a distributor plate, the reference point is at the arrow in the middle of the plate. For versions with a distribution assembly the reference point is between bottle number 1 and the last bottle. Separate the upper compartment from the lower compartment to see the reference point.
 With ▶ Adjust you can correct the distribution arm if the unit does not move to the reference point correctly. Use the two arrow keys to correct the position.		

3. Then, in menu "**Diagnostics/System test/Reset/Distribution arm**", carry out the distribution arm test.





12.2.3 Peristaltic pump sample volume

The sample volume of the peristaltic pump is calibrated at the factory.

 In order to calibrate the sample volume, a measurement beaker with a volume of at least 200 ml is required.

- ▶ Remove the pump hose from the hose gland and guide it into the graduated beaker.

Proceed as follows to calibrate:

Menu/Calibration active		
Function	Options	Info
▶ Sample volume		
▶ 1-point calibration		
Distributor position	Selection ▪ Front ▪ Bottle x ▪ Back	Select the distributor position.
Sample volume	20 to 2000 ml Factory setting 100 ml	Set the sample volume.
▷ Start sampling	Action	The progress of the sampling operation is displayed.
 Check whether the sample volume is correct. Press ▶ No to enter the sample volume actually taken, e.g. 110 ml. Press ▷ Yes to repeat the sampling.		
▶ 2-point calibration		
 Use 2-point calibration for levels that fluctuate greatly. The second sampling point must be either higher or lower (height difference of at least 1 m).		
Distributor position	Selection ▪ Front ▪ Bottle x ▪ Back	Select the distributor position.
Sample volume	20 to 2000 ml Factory setting 100 ml	Set the sample volume.
▷ Start 1. sampling	Action	The progress of the sampling operation is displayed.
 Check whether the sample volume is correct. Press ▶ No to enter the sample volume actually taken, e.g. 110 ml. Press ▷ Yes to repeat the sampling.		
▷ Start 2. sampling	Action	The progress of the sampling operation is displayed.
 Check whether the sample volume is correct. Press ▶ No to enter the sample volume actually taken, e.g. 110 ml. Press ▷ Yes to repeat the sampling.		

12.3 Replacing the pump tube

WARNING

Rotating parts

Minor to medium injury possible.

- ▶ Take the sampler out of service before opening the peristaltic pump.
- ▶ Secure the sampler against unintentional start-up whilst you work on the opened hose pump.

Opening the peristaltic pump

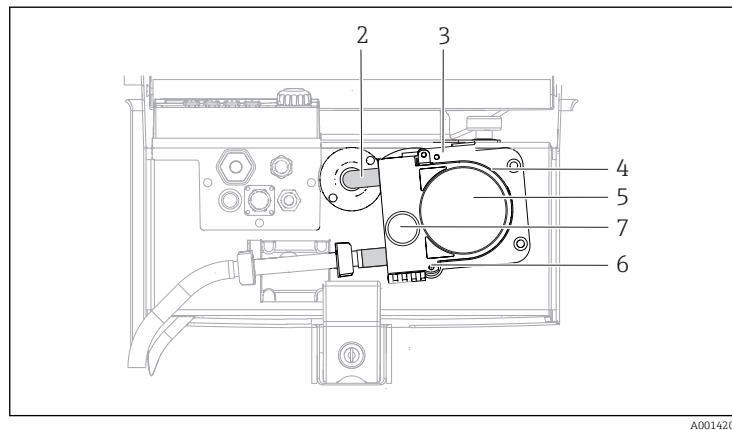

- 2 Pump tubing
- 3 Fastening clip
- 4 Pump bracket
- 5 Pump head cover
- 6 Positioning pin
- 7 Knurled head screw

 15 Opening the peristaltic pump

1. Take the sampler out of service by pausing a program that is currently running.
2. Open the fastening clip (item 3) and push the pump bracket (item 4) upwards.
3. Remove the knurled head screw (item 7) and open the pump head cover (item 5) to the right.
4. Remove the knurled head screw (item 7) and open the pump head cover (item 5) to the right.

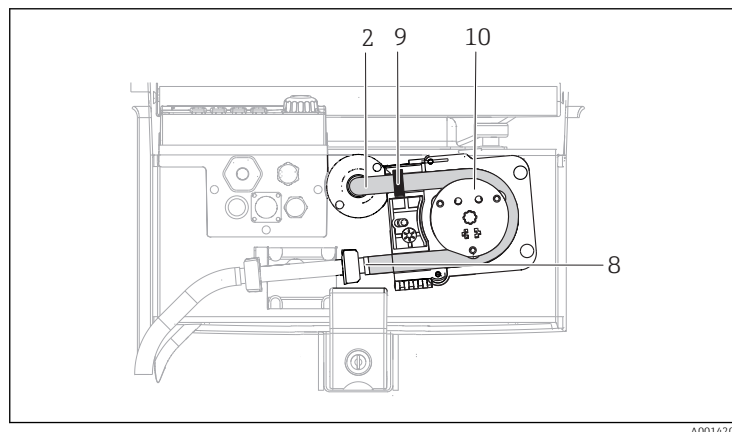

Replacing the pump tube



- 2 Pump tubing
- 8 Terminal
- 9 Marking ring
- 10 Roller

 16 Replacing the pump tube

1. Remove the clamp (item 8) and remove the pump tube (item 2) from the pump.
2. Remove any silicone deposits on the roller (item 10) and the flexible pump bracket.
3. Make sure the roller and all the rolls turn smoothly and evenly.
4. Apply some lubricant to the roller.
5. Secure the new pump tube to the pressure sensor with the clamp (item 8).
6. Guide the pump tube around the roller and insert the marking ring into the groove (item 9).
7. Close the pump head cover and screw it tight. Close the pump bracket.
8. To avoid incorrect metering, reset the tube life to zero under **Menu/Diagnostics/Operating time information/Pump tube life** using the "Reset" function.

 Calibrate the sample volume each time you replace a pump tube. →  121

12.4 Cleaning

12.4.1 Housing

- ▶ Clean the front of the housing using commercially available cleaning agents only.

The front of the housing is resistant to the following in accordance with DIN 42 115:

- Ethanol (for a short time)
- Diluted acids (max. 2% HCl)
- Diluted bases (max. 3% NaOH)
- Soap-based household cleaning agents

NOTICE

Cleaning agents not permitted

Damage to the housing surface or housing seal

- ▶ Never use concentrated mineral acids or alkaline solutions for cleaning.
- ▶ Never use organic cleaners such as acetone, benzyl alcohol, methanol, methylene chloride, xylene or concentrated glycerol cleaner.
- ▶ Never use high-pressure steam for cleaning.

12.4.2 Wetted parts

- ▶ After cleaning, rinse all wetted parts thoroughly with clear water to ensure that all cleaning agent residue has been removed so it cannot affect subsequent medium samples.

Version with peristaltic pump

Clean the wetted parts as follows:

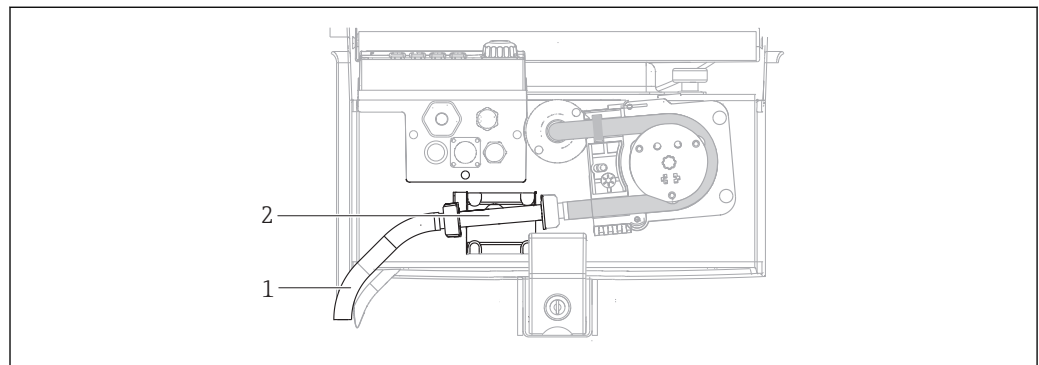

17 Version with peristaltic pump

- 1 Suction line
- 2 Pressure sensor

1. Connect a container containing clear water to the tube connection.
2. Remove the bottles from the sample compartment.
3. Rinse the wetted parts with clear water by taking a manual sample or by performing a pump test (under **Menu/Diagnostics/System test/ -> Peristaltic pump/Pump purge/Pump suction**
4. Release the couplings to the left and right of the pressure sensor (item 2). Clean the tube piece carefully with a bottle brush and rinse it with clear water.
5. Reconnect the sample supply to the tube connection and put the bottles back in the sample compartment.

⚠ WARNING**Rotating parts**

Minor to medium injury possible.

- ▶ Do not open the cover of the peristaltic pump while the pump is operating.
- ▶ Secure the sampler against unintentional start-up whilst you work on the opened hose pump.

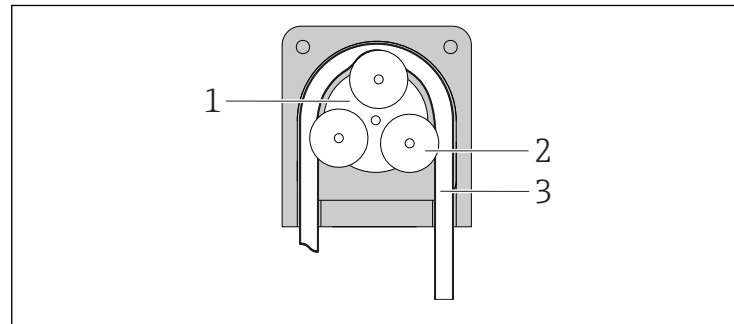
Interior of peristaltic pump

- 1 Pump rotor
- 2 Roller
- 3 Pump tubing

A0014029

18 Interior view of the peristaltic pump

1. Take the sampler out of service by pausing a program that is currently running.
2. Open the peristaltic pump as described in the "Replacing the pump tube" → 122section.
3. Remove the pump tube.
4. Remove any silicone deposits on the roller and the flexible pump bracket.
5. Make sure the roller turns smoothly and evenly

Cleaning the distribution arm**Clean the distribution arm as follows:**

1. Open the fastening clips on the side to separate the top device section from the bottom device section. Turn the top device section 90°.
2. Unscrew the distribution arm.
3. Clean the distribution arm with water or soapsuds. Use a bottle brush if necessary.
4. Reinstall the clean distribution arm.

12.4.3 Sample compartment

The sample compartment has a continuous inner plastic lining.

1. Remove the bottle trays and the distribution pan.
2. Remove the bottles.
3. Remove the distribution arm. See also
4. Spray-clean the sample compartment with a water hose.

i You can wash the PE and glass bottles in a dishwasher at 60 °C.

12.4.4 Digital sensors

⚠ CAUTION

Cleaning not switched off during calibration or maintenance activities

Risk of injury due to medium or cleaning agent!

- ▶ If a cleaning system is connected, switch it off before removing a sensor from the medium.
- ▶ If you wish to check the cleaning function and have therefore not switched off the cleaning system, wear protective clothing, goggles and gloves or take other appropriate measures.

Replacing the sensor while ensuring measuring point availability

If an error occurs or the maintenance schedule stipulates that the sensor has to be replaced, use a new sensor, or a sensor that has been precalibrated in the laboratory.

- A sensor is calibrated in the laboratory under optimum external conditions, thereby ensuring better quality of measurement.
- You must perform onsite calibration if you use a sensor that is not precalibrated.

1. Remove the sensor that requires maintenance.
2. Install the new sensor.
 - ↳ The sensor data are automatically accepted by the transmitter. A release code is not required. Measurement is resumed.
3. Take the used sensor back to the laboratory.
 - ↳ In the laboratory you can get the sensor ready for reuse while ensuring the availability of the measuring point.

Prepare the sensor for reuse

1. Clean sensor.
 - ↳ For this purpose, use the cleaning agent specified in the sensor manual.
2. Inspect the sensor for cracks or other damage.
3. If no damage is found, regenerate the sensor. Where necessary, store the sensor in a regeneration solution (→ sensor manual).
4. Recalibrate the sensor for reuse.

12.5 Replacing the rechargeable batteries

First remove the cover of the battery compartment to replace the batteries.

⚠ WARNING

Device is live

Incorrect connection may result in injury or death

- ▶ If a power unit or charger is connected, disconnect it from the power supply.

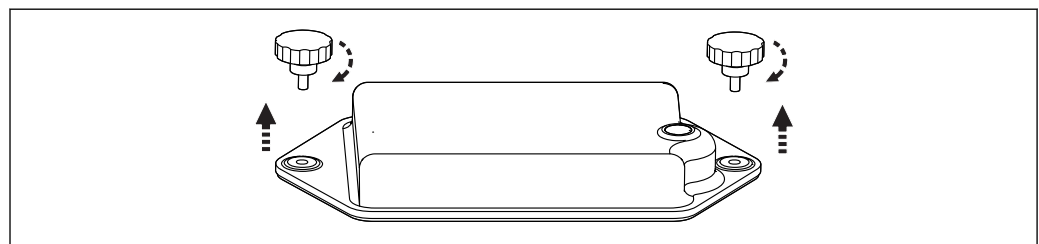

A0035817

1. Release both securing screws.
2. Remove the cover of the battery compartment.

3. Remove the old batteries and release the plug-in connections.

- 4.

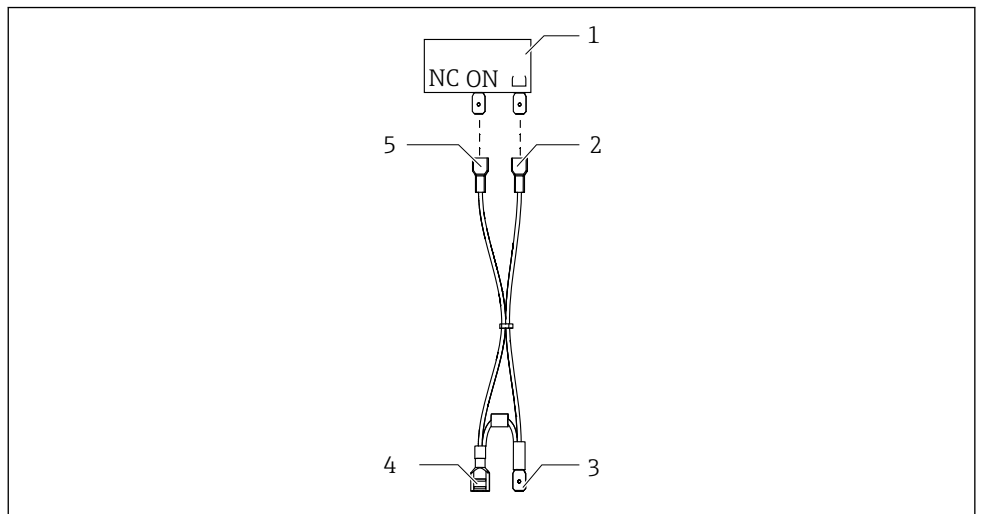

A0035822

- 1 Switch
- 2 Connection to "Grounding" switch
- 3 Connection to battery PN
- 4 Connection to battery, red
- 5 Connection to "ON" switch

Connect the new batteries.

5. Insert the new batteries and secure the battery compartment cover.

12.6 Technical support

-  We recommend the purchase and use of an SD card (see accessories). You can save the entire sampler configuration on the SD card (see "Data management" section) and make the data available to the service team should you be in need of technical assistance.

13 Repair

13.1 Spare parts

 Contact your Endress+Hauser Service if you have any questions regarding spare parts.

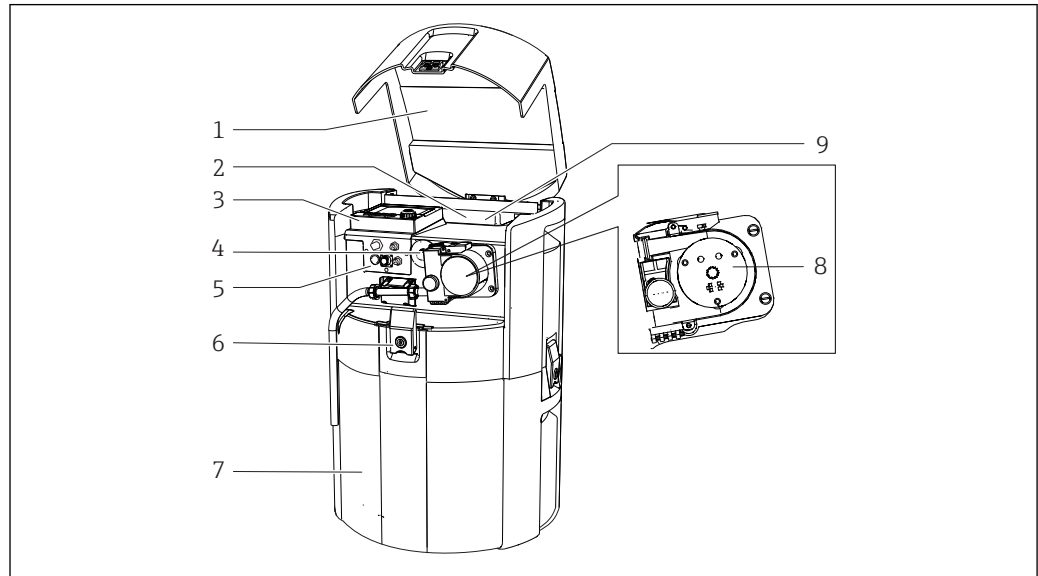

A0014211

 19 Spare parts

Item No.	Description and contents	Order number Spare parts kit
1	Lid for housing upper complete	71119023
2	Rechargeable battery pack	71119018
3	Housing cover with display CM44	71119035
4	Pump tubing, 2 pcs.	71114701
	Pump tubing, 25 pcs.	71114702
5	Peristaltic pump: pump housing	71119029
6	Lockable latch with keys	71119017
	Keys	71119017
7	Housing base	71119022
8	Peristaltic pump: pump head	71119008
9	Battery cover with switch	71389506

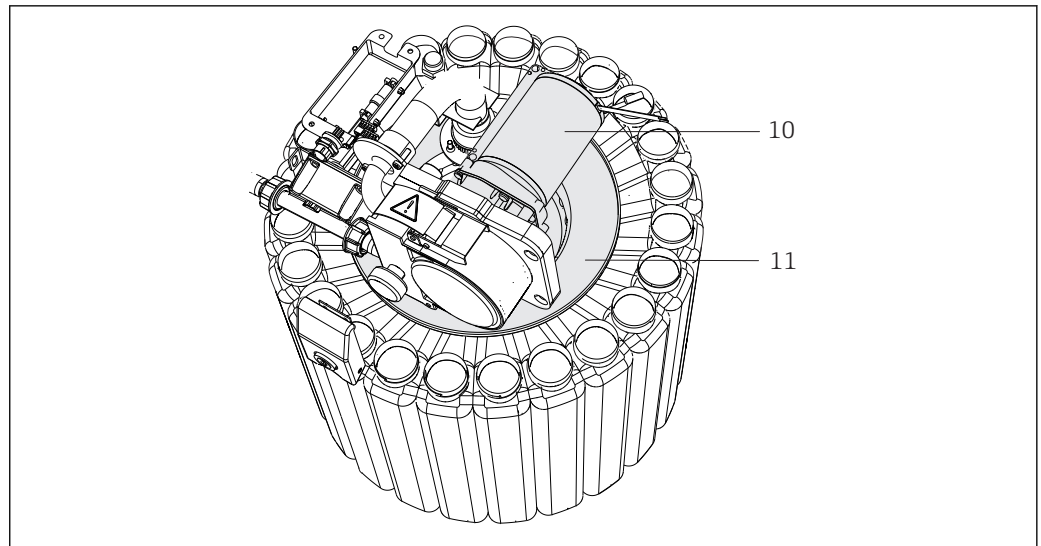

A0014212

▣ 20 Spare parts

Item No.	Description and contents	Order number Spare parts kit
10	Peristaltic pump: pump motor	71119030
11	Downholder complete	71119013
	Distribution arm	71119007
	Distribution arm	71119025
	Seal set for peristaltic pump: O-ring ID=12.42 W=1.78 OD=15.98 EPDM, 2 pcs. O-ring ID=20.92 W=2.62 OD=25.53 EPDM, 2 pcs. O-ring ID=13.00 W=4.00 OD=21.00 NBR, 1 pc.	71110928

13.2 Return

The product must be returned if repairs or a factory calibration are required, or if the wrong product was ordered or delivered. As an ISO-certified company and also due to legal regulations, Endress+Hauser is obliged to follow certain procedures when handling any returned products that have been in contact with medium.

To ensure the swift, safe and professional return of the device:

- ▶ Refer to the website www.endress.com/support/return-material for information on the procedure and conditions for returning devices.

13.3 Disposal

The device contains electronic components. The product must be disposed of as electronic waste.

- ▶ Observe the local regulations.

i Batteries must always be disposed of in accordance with local regulations on battery disposal.

14 Accessories

The following are the most important accessories available at the time this documentation was issued.

- For accessories not listed here, please contact your Service or Sales Center.

Order no.	Complete suction line
71111233	Suction line ID 10 mm (3/8"), PVC clear, reinforced fabric, length 10 m (33 ft), suction head V4A
71111234	Suction line ID 10 mm (3/8"), EPDM black, length 10 m (33 ft), suction head V4A
71111235	Suction line ID 13 mm (1/2"), PVC green, reinforced spiral wire, length 10 m (33 ft), suction head V4A
71111236	Suction line ID 13 mm (1/2"), EPDM black, length 10 m (33 ft), suction head V4A
71111237	Suction line ID 16 mm (5/8"), PVC green, reinforced spiral wire, length 10 m (33 ft), suction head V4A
71111238	Suction line ID 16 mm (5/8"), EPDM black, length 10 m (33 ft), suction head V4A
71111239	Suction line ID 19 mm (3/4"), PVC green, reinforced spiral wire, length 10 m (33 ft), suction head V4A
71111240	Suction line ID 19 mm (3/4"), EPDM black, length 10 m (33 ft), suction head V4A
71111482	... m; suction line coil ID 10 mm (3/8"), PVC
71111484	... m; suction line coil ID 10 mm (3/8"), EPDM

Order no.	Base, complemented
71111864	CSP44 base + 1 x 20 liter (5.28 US gal.), PE
71111866	CSP44 base + 12 x 2 liter (0.53 US gal.), PE
71111867	CSP44 base + 12 x 0.7 liter (0.18 US gal.), glass
71111868	CSP44 base + 24 x 1 liter (0.26 US gal.), PE
71111870	CSP44 base + 12 x 1 liter (0.26 US gal.) + 6 x 2 liter (0.53 US gal.), PE

Order no.	Bottles + covers
71112221	20 liter (5.28 US gal.) PE + cover, 1 pc.
71111178	2 liter (0.53 US gal.) PE wedge-shaped bottle + cover, 12 pcs.
71111176	1 liter (0.26 US gal.) PE wedge-shaped bottle + cover, 24 pcs.
71111874	0.7 liter (0.18 US gal.) glass + cover, 12 pcs.

Order no.	Accessories base
71111878	Kit CSP44 base cover, transporting
71111880	Kit CSP44 freezer cartridge

Order no.	Tubing customized
71114701	Pump tubing, 2 pcs.
71114702	Pump tubing, 25 pcs.

Order no.	Installation
71111881	CSP44 suspension kit, for use in 500 to 600 mm diameter manhole

Order no.	Power supply
71111872	Lead-acid battery 24 V DC
71111882	Kit CSP44 charger adapter cable, battery for power unit
71111883	Kit CSP44 power unit/charger for indoor use, 100 to 120/200 to 240 V AC $\pm 10\%$, 50/60 Hz
71111884	Kit CSP44 power unit/charger for outdoor use, IP 65, 100 to 120/200 to 240 V AC $\pm 10\%$, 50/60 Hz

Order no.	Retrofit kits
71111879	Kit CSP44 retrofit distribution system (distribution arm, distribution drive)
71251042	Kit CSP44 power unit/charger for outdoors; UL, IP65, 115VAC, US connector
71389506	Kit CSP44 battery cover with switch

Order no.	Suction head
71111184	Suction head V4A for ID 10 mm (3/8"), 1 pc.

Order no.	Communication; software
51516983	Commubox FXA291 + FieldCare Device Setup
71129799	Field Data Manager software; 1 license, analysis report
	Activation code for PROFIBUS DP

14.1 Measuring cable

Memosens data cable CYK10

- For digital sensors with Memosens technology
- Product Configurator on the product page: www.endress.com/cyk10

 Technical Information TI00118C

Measuring cable CYK81

- Unterminated cable for extending sensor cables (e.g. Memosens, CUS31/CUS41)
- 2 x 2 cores, twisted with shielding and PVC sheath (2 x 2 x 0.5 mm² + shielding)
- Sold by meter, Order No.: 51502543

14.2 Sensors

 You can only connect sensors with M12 plug.

14.2.1 Glass electrodes

Orbisint CPS11D

- pH sensor for process technology
- With dirt-repellent PTFE diaphragm
- Product Configurator on the product page: www.endress.com/cps11d

 Technical Information TI00028C

Memosens CPS31D

- pH electrode with gel-filled reference system with ceramic diaphragm
- Product Configurator on the product page: www.endress.com/cps31d



Technical Information TI00030C

Ceraliquid CPS41D

- pH electrode with ceramic junction and KCl liquid electrolyte
- Product Configurator on the product page: www.endress.com/cps41d



Technical Information TI00079C

Ceragel CPS71D

- pH electrode with reference system including ion trap
- Product Configurator on the product page: www.endress.com/cps71d



Technical Information TI00245C

Orbipore CPS91D

- pH electrode with open aperture for media with high dirt load
- Product Configurator on the product page: www.endress.com/cps91d



Technical Information TI00375C

Orbipac CPF81D

- Compact pH sensor for installation or immersion operation
- In industrial water and wastewater
- Product Configurator on the product page: www.endress.com/cpf81d



Technical Information TI00191C

14.2.2 Pfaudler electrodes

Ceramax CPS341D

- pH electrode with pH-sensitive enamel
- Meets highest demands of measuring accuracy, pressure, temperature, sterility and durability
- Product Configurator on the product page: www.endress.com/cps341d



Technical Information TI00468C

14.2.3 ORP sensors

Orbisint CPS12D

- ORP sensor for process technology
- Product Configurator on the product page: www.endress.com/cps12d



Technical Information TI00367C

Ceraliquid CPS42D

- ORP electrode with ceramic junction and KCl liquid electrolyte
- Product Configurator on the product page: www.endress.com/cps42d



Technical Information TI00373C

Ceragel CPS72D

- ORP electrode with reference system including ion trap
- Product Configurator on the product page: www.endress.com/cps72d



Technical Information TI00374C

Orbipac CPF82D

- Compact ORP sensor for installation or immersion operation in process water and wastewater
- Product Configurator on the product page: www.endress.com/cpf82d



Technical Information TI00191C

Orbipore CPS92D

- ORP electrode with open aperture for media with high dirt load
- Product Configurator on the product page: www.endress.com/cps92d



Technical Information TI00435C

14.2.4 pH ISFET sensors

Tophit CPS441D

- Sterilizable ISFET sensor for low-conductivity media
- Liquid KCl electrolyte
- Product Configurator on the product page: www.endress.com/cps441d



Technical Information TI00352C

Tophit CPS471D

- Sterilizable and autoclavable ISFET sensor for food and pharmaceuticals, process engineering
- Water treatment and biotechnology
- Product Configurator on the product page: www.endress.com/cps471d



Technical Information TI00283C

Tophit CPS491D

- ISFET sensor with open aperture for media with high dirt load
- Product Configurator on the product page: www.endress.com/cps491d



Technical Information TI00377C

14.2.5 Conductivity sensors with inductive measurement of conductivity

Indumax CLS50D

- High-durability inductive conductivity sensor
- For standard and hazardous area applications
- With Memosens technology
- Product Configurator on the product page: www.endress.com/cls50d



Technical Information TI00182C

14.2.6 Conductivity sensors with conductive measurement of conductivity

Condumax CLS15D

- Conductive conductivity sensor
- For pure water, ultrapure water and hazardous area applications
- Product Configurator on the product page: www.endress.com/CLS15d



Technical Information TI00109C

Condumax CLS16D

- Hygienic, conductive conductivity sensor
- For pure water, ultrapure water and Ex applications
- With EHEDG and 3A approval
- Product Configurator on the product page: www.endress.com/CLS16d



Technical Information TI00227C

Condumax CLS21D

- Two-electrode sensor in plug-in head version version
- Product Configurator on the product page: www.endress.com/CLS21d



Technical Information TI00085C

Memosens CLS82D

- Four-electrode sensor
- With Memosens technology
- Product Configurator on the product page: www.endress.com/cls82d



Technical Information TI01188C

14.2.7 Oxygen sensors

Oxymax COS22D

- Sterilizable sensor for dissolved oxygen
- With Memosens technology or as an analog sensor
- Product Configurator on the product page: www.endress.com/cos22d



Technical Information TI00446C

Oxymax COS51D

- Amperometric sensor for dissolved oxygen
- With Memosens technology
- Product Configurator on the product page: www.endress.com/cos51d



Technical Information TI00413C

Oxymax COS61D

- Optical oxygen sensor for drinking water and industrial water measurement
- Measuring principle: quenching
- With Memosens technology
- Product Configurator on the product page: www.endress.com/cos61d



Technical Information TI00387C

Memosens COS81D

- Sterilizable, optical sensor for dissolved oxygen
- With Memosens technology
- Product Configurator on the product page: www.endress.com/cos81d



Technical Information TI01201C

14.2.8 Chlorine sensors

CCS142D

- Membrane-covered amperometric sensor for free chlorine
- Measuring range 0.01 to 20 mg/l
- With Memosens technology
- Product Configurator on the product page: www.endress.com/ccs142d



Technical Information TI00419C

14.2.9 Ion-selective sensors

ISEmax CAS40D

- Ion selective sensors
- Product Configurator on the product page: www.endress.com/cas40d

 Technical Information TI00491C

14.2.10 Turbidity sensors

Turbimax CUS51D

- For nephelometric measurements of turbidity and solids in wastewater
- 4-beam scattered light method
- With Memosens technology
- Product Configurator on the product page: www.endress.com/cus51d

 Technical Information TI00461C

14.2.11 SAC and nitrate sensors

Viomax CAS51D

- SAC and nitrate measurement in drinking water and wastewater
- With Memosens technology
- Product Configurator on the product page: www.endress.com/cas51d

 Technical Information TI00459C

14.2.12 Interface measurement

Turbimax CUS71D

- Immersion sensor for interface measurement
- Ultrasonic interface sensor
- Product Configurator on the product page: www.endress.com/cus71d

 Technical Information TI00490C

15 Technical data

15.1 Input

Measured values → Documentation of the connected sensor

Measuring ranges → Documentation of the connected sensor

Input types (optional)

- Up to two analog inputs
- Up to two binary inputs
- 1 to 2 digital inputs for sensors with Memosens protocol (optional)

15.2 Binary input, passive (optional)

Span 12 to 30 V, galvanically isolated

Signal characteristics Minimum pulse width: 100 ms

15.3 Temperature inputs (optional)

Measuring range -30 to 70 °C (-20 to 160 °F)

Accuracy ± 0.5 K

Type of input Pt1000

15.4 Analog input, passive/active (optional)

Span 0/4 to 20 mA, galvanically isolated

Accuracy ±0.5 % of measuring range

15.5 Output optional

Output signal

Communication

- 1 service interface
- Accessible via front panel connection (optional)
- Commubox FXA291 (accessory) required for communication with the PC

15.6 Power supply

Electrical connection See the "Electrical connection" section (→  17)

Supply voltage  The sampler cannot be operated without the battery.

Internal 24 V DC, 7.2 Ah lead-acid battery

Field-suitable IP 67	100 to 240 V AC; charge current 2.0 A; also suitable for mains operation
Indoor use	100 to 240 V AC; charge current 2.0 A; also suitable for mains operation
 Mains operation means that the sampler is in operation during the charging process.	

Specification of charger for Liquiport 2010 CSP44:

- Max. output current = 2 A
- Max. output voltage = 29.5 V
- Double/reinforced insulation
- Constant current
- CSA or UL recognized according to UL 60950-1, UL 60601-1 or UL 61010-1 or the relevant CSA standards

Power consumption Max. 60 W (only when using the battery chargers indicated by the manufacturer)

Capacity of battery 42 hours for 168 samples (at a sampling interval of 15 minutes, a sampling volume of 100 ml and a suction height of 4 meters)

Standby capacity: 144 hours

 Data applicable if analog input is switched off and for devices without a Memosens input.

Fuses **Input fuse:**
T3.15A (behind the plate of the distribution arm in the black box)

Electronics fuse:
T4.0A (in the controller)

15.7 Performance characteristics

Sampling methods **Vacuum pump/peristaltic pump/sampling assembly:**

- Event sampling
- Single and multiple samples
- Sampling table

Peristaltic pump:

- Time-paced
- In proportion to volume
- Flow proportional sampling/time override (CTVV)

Dosing volume	Peristaltic pump: 10 to 10000 ml (0.3 to 340 fl.oz.)  The dosing accuracy and the repeatability of a sample volume < 20 ml can vary, depending on the specific application.
Dosing accuracy	Peristaltic pump: ± 5 ml (0.17 fl.oz.) or 5 % of the set volume
Repeatability	5 %
Intake speed	> 0.5 m/s (> 1.6 ft/s) for ≤ 13 mm (1/2") ID, as per EN 25667, ISO 5667, CEN 16479-1 > 0.6 m/s (> 1.9 ft/s) for 10 mm (3/8") ID, in accordance with Ö 5893; US EPA
Suction height	Peristaltic pump: Max. 8 m (26 ft)
Hose length	Max. 30 m (98 ft)

15.8 Environment

Ambient temperature range	0 to 40 °C (32 to 104 °F)  Do not install the device in areas with high temperature and direct sunlight!
Storage temperature	-20 to 60 °C (-4 to 140 °F)
Electrical safety	In accordance with EN 61010-1, protection class I, environment ≤ 2000 m (6500 ft) above MSL. The device is designed for pollution degree 2.
Humidity	10 to 95%, not condensing
Degree of protection	<ul style="list-style-type: none"> ■ Sample compartment: IP 54 ■ Sampler with cover closed: IP 54 ■ Controller: IP 65
Electromagnetic compatibility	Interference emission and interference immunity as per EN 61326-1:2013, Class A for Industry

15.9 Process

Medium temperature range	2 to 50 °C (36 to 122 °F)
Process pressure	Unpressurized, open channel (unpressurized sampling)

Medium properties

Peristaltic pump

Sample media has to be free of abrasive substances.

 Pay attention to the material compatibility of the wetted parts.

Process connection

- **Vacuum pump:**

Suction line ID 10 mm (3/8"), 13 mm (1/2"), 16 mm (5/8") or 19 mm (3/4")

- **Peristaltic pump:**

Intake hose ID 10 mm (3/8")

15.10 Mechanical construction

Dimensions

See the "Installation" section →  14

Weight

Sampler version	Weight
Empty weight	15 kg (33 lbs)
Overall weight with battery and 24 x 1 l bottles	19 kg (42 lbs)
Upper compartment with battery	10 kg (22 lbs)
Lower compartment with 24 x 1 l bottles	9 kg (20 lbs)

 With full bottles the weight of the sampler is more than 25 kg (55 lbs). To comply with ISO 11228-1 only transport the sampler together with a second person.

Materials

 Plastic polystyrene VO can change color when exposed to direct sunlight. For outdoor use without a weather protection cover, the use of Plastic ASA+PC VO is recommended. The functionality is not affected by the discoloration.

Wetted parts	Peristaltic pump
Dosing tube	-
Dosing chamber cover	-
Conductivity sensors	-
Conductivity sensors	-
Dosing chamber	-
Dosing system outflow hose	-
Pump tubing	Silicone
Process seal	-
Distribution arm	Plastic PP
Distribution arm cover	Plastic PE
Distribution plate	Plastic PS
Composite container/bottles	Plastic PE, glass (depending on version)
Intake hose	Plastic PVC, EPDM (depending on version)

Wetted parts	Peristaltic pump
Hose connection	Plastic PP
Rinse connection	-

 Choose process seal depending on the application. Viton is recommended for standard applications involving watery samples.

Liquiport 2010 CSP44	
Housing	Plastic PE
Housing parts	Plastic PE
Bottles	Plastic PE, glass (depending on version)
Distribution arm	Plastic PE
Sensor housing	Plastic PP
Pump tubing	Silicone
Intake hose	Plastic PVC reinforced braided, EPDM black

Process connections

Peristaltic pump:
Intake hose ID 10 mm (3/8")

Index

A

- Accessories 130
 - Measuring cable 131
 - Sensors 131
- Adapting the diagnostic behavior 96
- Ambient temperature range 138

B

- Binary input 136
- Bottle statistics 109

C

- Calibration 121
- Check
 - Connection 22
 - Installation 16
- Cleaning 124
- Configure
 - Actions 27
 - Free text 28
 - Numerical values 27
 - Picklists 26
 - Tables 28
 - User definable screens 31
- Connection
 - Check 22
 - Measuring device 17
 - Sensors 19
 - Supply voltage 137
 - Web server 23

D

- Declaration of Conformity 13
- Degree of protection 138
- Designated use 7
- Device description 10
- Device test 113
- Device-specific diagnostic messages 97
- Device-specific errors 94
- Diagnostic messages
 - Adapting 95
 - Classification 95
 - Device-specific 97
 - Local display 95
 - Sensor-specific 103
- Diagnostics list 104
- Dimensions 139
- Disposal 129
- Distribution arm calibration 121
- Documentation 6

E

- Electromagnetic compatibility 138
- Ensuring the degree of protection 21
- Event logbook 104

F

- Firmware history 116

H

- Humidity 138

I

- Incoming acceptance 12
- Information on operating times 115
- Input
 - Measured values 136
- Input/output 136
- Inputs/outputs 115
- Installation
 - Check 16
- Installation conditions 14

L

- Logbooks 104

M

- Maintenance 120
- Materials 139
- Measured values 136
- Measuring ranges 136

N

- Nameplate 12

O

- Operation
 - Configure 26
- Operational safety 8

P

- Power supply 137
 - Connecting the measuring device 17
 - Sensor connection 19
 - Supply voltage 137
- Process errors without messages 94
- Process pressure 139
- Product safety 9
- Program logbook 107

R

- Repair 128
- Replacing the pump tube 122
- Replacing the rechargeable batteries 126
- Requirements for personnel 7
- Resetting the measuring device 115
- Return 129

S

- Safety Instructions 7
- Scope of delivery 12
- Security
 - IT 9

Operation	8
Product	9
Workplace safety	7
Sensor	
Connection	19
Sensor calibration	121
Sensor information	111
Sensor-specific diagnostics messages	103
Service interface	23
Simulation	111
Spare parts	128
State of the art	9
Storage temperature	138
Supply voltage	137
Symbols	5
System information	110
System integration	
Service interface	23
T	
Technical data	136
Environment	138
Input	136
Mechanical construction	139
Output	136
Performance characteristics	137
Technical personnel	7
Terminal diagram	11
Troubleshooting	94
Diagnostic information	95
General troubleshooting	94
Types of input	136
U	
Use	
Designated	7
User definable screens	31
W	
Warnings	5
Weight	139
Workplace safety	7

www.addresses.endress.com
