

# M-Series<sup>®</sup> M1000

## Electromagnetic Flow Meter





---



## CONTENTS

Safety Precautions and Instructions . . . . .	5
System Description . . . . .	5
Approvals . . . . .	6
Unpacking and Inspection . . . . .	6
Rigging, Lifting and Moving Large Units . . . . .	6
Meter Location, Orientation and Applications . . . . .	8
Temperature Ranges . . . . .	8
Remote Amplifier Outdoor Location . . . . .	8
Pipelines and Fluid Flow . . . . .	9
Meter Orientation . . . . .	9
Straight Pipe Requirements . . . . .	10
Pipe Reducer Requirements . . . . .	10
Chemical Injection Applications . . . . .	10
Partially-Filled Pipe Situations. . . . .	11
Amplifier Mounting Configuration Options . . . . .	12
Meter Mount Configuration . . . . .	12
Remote Mount Configuration. . . . .	12
Submersible Option. . . . .	12
Protection Class . . . . .	13
Meter Gaskets and Grounding . . . . .	14
Meter/Pipeline Connection Gaskets . . . . .	14
Meter Grounding . . . . .	14
Conductive Pipe Grounding. . . . .	14
Pipelines with Cathodic Protection . . . . .	14
Non-Conductive Pipe Grounding . . . . .	15
Power Connections . . . . .	15
Wiring Safety . . . . .	15
Opening the M1000 Cover. . . . .	16
Auxiliary Power . . . . .	16
Remote Version. . . . .	17
Configuring Input/Output (I/O). . . . .	18
M1000 Main Menu Programming Options . . . . .	19
Screen Layout. . . . .	19
Function Buttons. . . . .	19

Setting Personal Identification Numbers (PINs) . . . . .	20
Menu Hierarchy Structure . . . . .	21
Meter Setup Menu . . . . .	22
Measurement Menu . . . . .	23
Input/Outputs Menu . . . . .	25
Totals Menu . . . . .	27
Communication Menu . . . . .	28
Miscellaneous Menu . . . . .	29
Information Menu . . . . .	29
PIN Menu . . . . .	30
Login Screen . . . . .	30
Maintenance . . . . .	30
Cleaning the Flow Tube and Electrode . . . . .	30
Troubleshooting . . . . .	31
Errors & Warnings . . . . .	31
LED Status Indicators . . . . .	32
Connecting an ORION ADE Endpoint to the M1000 Meter . . . . .	33
Wiring . . . . .	33
Programming . . . . .	33
Specifications . . . . .	34

## SAFETY PRECAUTIONS AND INSTRUCTIONS

Some procedures in this manual require special safety considerations. In such cases, the text is emphasized with the following symbols:

Symbol	Explanation
	Warning indicates the potential for severe personal injury, death or substantial property damage. Comply with the instructions and proceed with care.
	Caution indicates the potential for minor personal injury or property damage. Comply with the instructions and proceed with care.

### CAUTION

**IF THE EQUIPMENT IS USED IN A MANNER NOT SPECIFIED BY THE MANUFACTURER, THE PROTECTION PROVIDED BY THE EQUIPMENT MAY BE IMPAIRED.**

### ATTENTION

**UTILISER L'ÉQUIPEMENT DE MANIÈRE NON SPÉCIFIÉE PAR LE FABRICANT POURRAIT DIMINUER LA PROTECTION ASSURÉE PAR L'ÉQUIPEMENT.**

## SYSTEM DESCRIPTION

The Badger Meter M-Series® Model M1000 electromagnetic flow meter is intended for fluid metering in most industries including water, wastewater, food and beverage, pharmaceutical and chemical.

The basic components of an electromagnetic flow meter are:

- The **detector**, which includes the flow tube, isolating liner and measuring electrodes.
- The **amplifier**, which is the electronic device responsible for the signal processing, flow calculation, display and output signals.

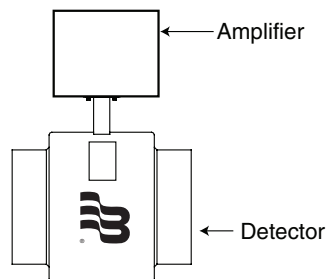

Figure 1: Amplifier and Detector

The construction materials of the wetted parts (liner and electrodes) should be appropriate for the specifications on the intended type of service. We recommend that you review all of the compatibilities consistent with the specifications. Each meter is factory tested and calibrated. A calibration certificate is included with each meter.

### WARNING

**CONSULT THE INSTALLATION INSTRUCTIONS BEFORE DETERMINING THE TEMPERATURE RATING OF THE CABLE.**

### AVERTISSEMENT

**CONSULTEZ LES INSTRUCTIONS D'INSTALLATION AVANT DE DÉTERMINER LES CARACTÉRISTIQUES THERMIQUES DU CÂBLE.**

### IMPORTANT

Wire connections must meet or exceed a temperature rating of 80° C.

## APPROVALS

- UL Std. No. 61010-1 (2nd Edition)  
Safety Requirements for Electrical Equipment for Measurement, Control, and Laboratory Use, Part 1: General Requirements

## UNPACKING AND INSPECTION

Follow these guidelines when unpacking the M-Series equipment.

- If a shipping container shows any sign of damage, have the shipper present when you unpack the meter.
- Follow all unpacking, lifting and moving instructions associated with the shipping container.
- Open the container and remove all packing materials. Store the shipping container and packing materials in the event the unit needs to be shipped for service.
- Verify that the shipment matches the packing list and your order form.
- Inspect the meter for any signs of shipping damage, scratches, or loose or broken parts.

**NOTE:** If the unit was damaged in transit, it is your responsibility to request an inspection report from the carrier within 48 hours. You must then file a claim with the carrier and contact Badger Meter for appropriate repairs or replacement.

- All detectors with polytetrafluoroethylene (PTFE) liners are shipped with a liner protector on each end to maintain proper form of the PTFE material during shipping and storage.

**NOTE:** Do not remove the liner protectors until you are ready to install.

- Storage: If the meter is to be stored, place it in its original container in a dry, sheltered location. Storage temperature ranges are: - 4...140° F (- 20...60° C).

## Rigging, Lifting and Moving Large Units

### **⚠ CAUTION**

**WHEN RIGGING, LIFTING OR MOVING LARGE UNITS, FOLLOW THESE GUIDELINES:**

### **⚠ ATTENTION**

**POUR LE GRÉEMENT, DU LEVAGE OU DU DÉPLACEMENT D'UNITÉS DE GRANDE TAILLE, VEUILLEZ SUIVRE CES INSTRUCTIONS :**

- DO NOT lift or move a meter by its amplifier, junction box, detector neck, or cables.
- Use a crane rigged with soft straps to lift and move meters with flow tubes that are between two inches and eight inches (50 mm and 200 mm). Place the straps around the detector body, between the flanges, on each side of the detector.

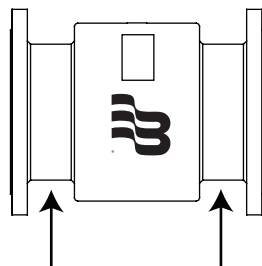

Place straps between flanges.

Figure 2: Rigging Large Units

- Use the sling-rigged method to lift large detectors into a vertical position while they are still crated. Use this method to position large detectors vertically into pipelines.

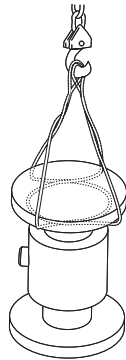
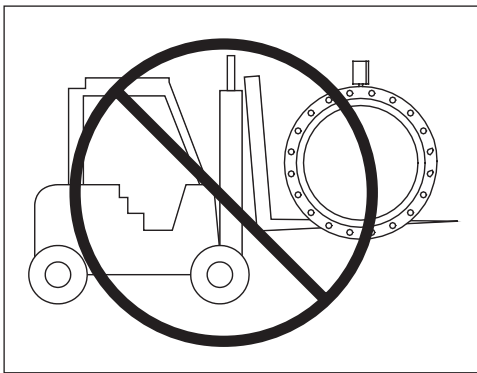
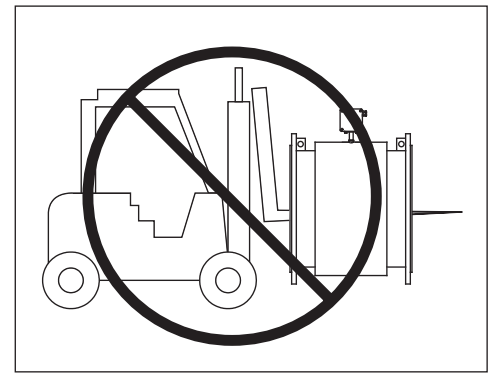

Figure 3: Sling-Rigged Lifting Methods

- Do not lift a detector with a forklift by positioning the detector body on the forks, with the flanges extending beyond the lift. This could dent the housing or damage the internal coil assemblies.
- Never place forklift forks, rigging chains, straps, slings, hooks or other lifting devices inside or through the detector's flow tube to hoist the unit. This could damage the isolating liner.



Do not lift detector with forklift.



Do not lift or rig lifting devices through detector.

Figure 4: Lifting and Rigging Cautions

## METER LOCATION, ORIENTATION AND APPLICATIONS

The M1000 provides two amplifier mounting options: an integral or meter mount option and a junction box/remote option.

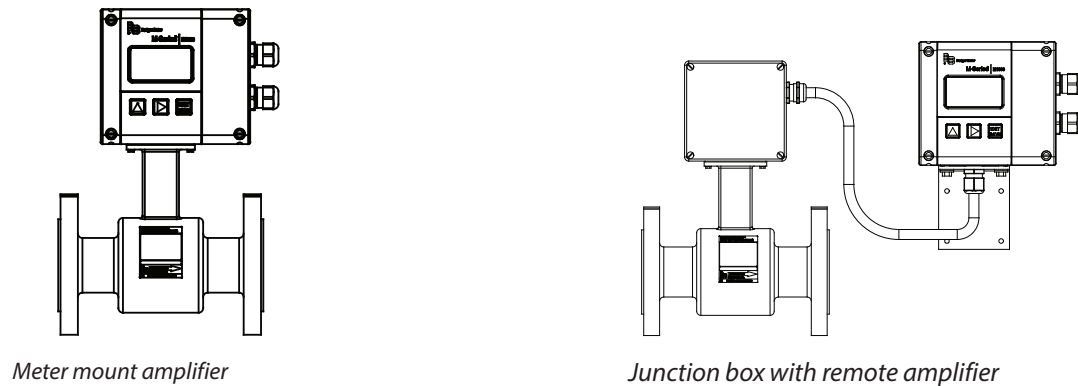

Figure 5: Amplifier mounting options

### Temperature Ranges

#### CAUTION

**TO PREVENT DAMAGE TO THE METER, STRICTLY OBSERVE THE AMPLIFIER'S AND DETECTOR'S MAXIMUM TEMPERATURE RANGES.**

#### ATTENTION

**AFIN D'ÉVITER TOUT DOMMAGE AU COMPTEUR, RESPECTEZ RIGOREUSEMENT LES PLAGES DE TEMPÉRATURES MAXIMALES DE L'AMPLIFICATEUR ET DU DÉTECTEUR.**

- In regions with extremely high ambient temperatures, protect the detector.
- In cases where fluid temperature exceeds 212° F (100° C), use the remote version.

<b>Amplifier</b>	Ambient temperature	- 4...140° F (-20...60° C)
<b>Detector</b>	Fluid temperature	PTFE / PFA
		Hard rubber
		- 40...302° F (- 40...150° C)
		32...176° F (0...80° C)

### Remote Amplifier Outdoor Location

The amplifier can be installed and operated outdoors. However, it must be protected from the elements, as follows:

- The ambient environment/temperature rating for the unit is - 4...140° F (-20...60° C).
- If an indoor location is within 150 feet (50 meters) of the detector, consider increasing the cable length and mounting the amplifier indoors.
- At minimum, fabricate a roof or shield over and/or around the amplifier to protect the LCD display screen from direct sunlight.



## Pipelines and Fluid Flow

Take the following precautions during installation:

- Do not install the meter on pipes with extreme pipe vibrations. If pipes are vibrating, secure the piping with appropriate pipe supports in front of and behind the meter. If vibrations cannot be restrained, mount the amplifier in a remote location.
- Do not install the detector close to pipeline valves, fittings or impediments that can cause flow disturbances.
- For detectors with PTFE liners, do not install the detector on suction sides of pumps.
- Do not install the detector on outlet sides of piston or diaphragm pumps. Pulsating flow can affect meter performance.
- Avoid installing the detector near equipment that produces electrical interference such as electric motors, transformers, variable frequency, and power cables.
- Verify that both ends of the signal cables are securely fastened.
- Place power cables and signal cables in separate conduits.
- Place the meter where there is enough access for installation and maintenance tasks.

## Meter Orientation

Mag meters can operate accurately in any pipeline orientation and can measure volumetric flow in forward and reverse directions.

**NOTE:** A "Forward Flow" direction arrow is printed on the detector label.

### Vertical Placement

Mag meters perform best when placed vertically, with liquid flowing upward and meter electrodes in a closed, full pipe.

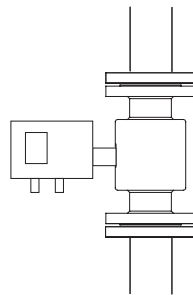

Figure 6: Vertical placement

Vertical placement allows the pipe to remain completely full, even in low flow, low pressure applications, and it prevents solids build-up, sediment deposit and accumulation on the liner and electrodes.

### Horizontal Placement

M1000 meters are equipped with an *Empty Pipe Detection* feature. If an electrode mounted in the pipe is not covered by fluid for five seconds, the meter will display an Empty Pipe Detection condition. The meter will send out an error message and stop measuring flow. When the electrode is again covered with fluid, the error message disappears and the meter will begin measuring.

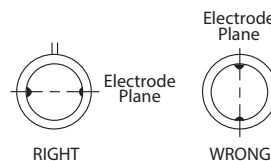

Figure 7: Horizontal placement

When installing the meter on a horizontal pipe, mount the detector to the pipe with the flow-measuring electrode axis in a horizontal plane (three and nine o'clock). This placement helps prevent solids build-up, sediment deposit and accumulation on the electrodes.

## Straight Pipe Requirements

Sufficient straight-pipe runs are required at the detector inlet and outlet for optimum meter accuracy and performance. An equivalent of three diameters of straight pipe is required on the inlet (upstream) side. Two diameters are required on the outlet (downstream) side.

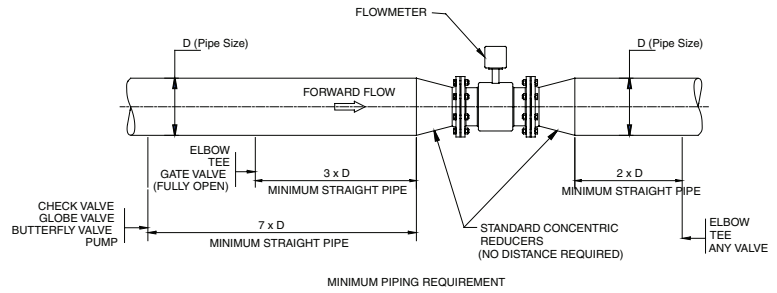

Figure 8: Straight pipe requirements

## Pipe Reducer Requirements

With pipe reducers, a smaller meter can be mounted in larger pipelines. This arrangement may increase low-flow accuracy. There are no special requirements for standard, concentric, pipe reducers.

Custom fabricated pipe reducers must have an approximate slope angle of 15 degrees to minimize flow disturbances and excessive loss of head. If this is not possible, install the custom pipe reducers as if they were fittings and install the required amount of straight pipe

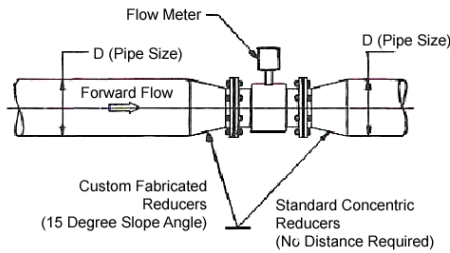

Figure 9: Pipe reducer requirements

## Chemical Injection Applications

For water line applications with a chemical injection point, install the meter upstream of the injection point. This eliminates any meter performance issues.

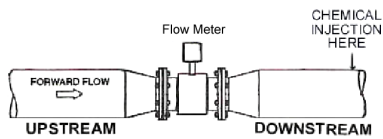

Figure 10: Chemical injection point upstream of meter

If a meter must be installed downstream of a chemical injection connection, the distance between the meter and the injection point should be between 50 and 100 feet (15 and 30 meters). The distance must be long enough to allow the water or chemical solution to reach the meter in a complete, homogeneous mixture.

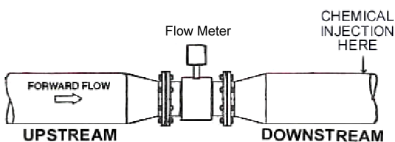

Figure 11: Chemical injection point upstream of meter

If the injection point is too close, the meter senses the two different conductivities for each liquid. This will likely result in inaccurate measurements. The injection method—spaced bursts, continuous stream of drips or liquid or gas—can also affect downstream readings by the meter.

## Partially-Filled Pipe Situations

In some locations, the process pipe may be momentarily only partially filled. Examples include: lack of back pressure, insufficient line pressure and gravity flow applications.

To eliminate these situations:

- Do not install the meter at the highest point of the pipeline.
- Do not install the meter in a vertical, downward flow section of pipe.
- Always position the ON/OFF valves on the downstream side of the meter.

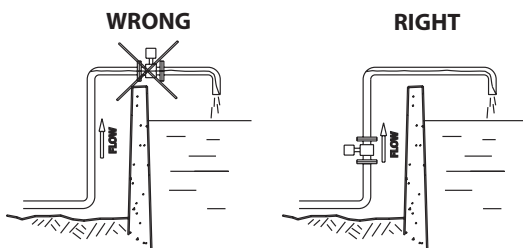
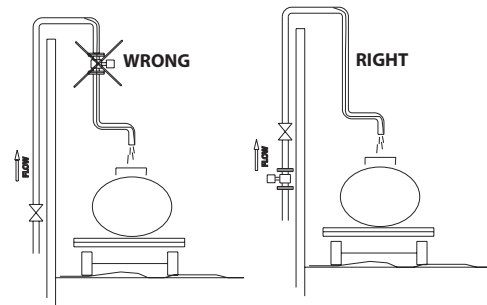

Figure 12: Incorrect meter placement



Do not install in a vertical, downward position.

Position "On/Off" valves on downstream side.

Figure 13: Position valves on downstream side

To minimize the possibility of partially-full pipe flows in horizontal, gravity or low pressure applications, create a pipe arrangement that ensures the detector remains full of liquid at all times.

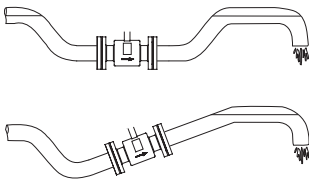

Figure 14: Pipe positioned to keep water in detector

## AMPLIFIER MOUNTING CONFIGURATION OPTIONS

There are two configuration options for mounting the amplifier. There are many options to accommodate a variety of meter-placement and environmental conditions.

### **Meter Mount Configuration**

The meter mount configuration has the amplifier mounted directly on the detector. This compact, self-contained configuration minimizes installation wiring.

### **Remote Mount Configuration**

The remote mount configuration places the amplifier at a location away from the fluid flow and detector. This is necessary in situations where process fluid temperature or the environment exceeds amplifier ratings.

The detector and amplifier are connected by wires, run through conduit, between junction boxes on the detector and the amplifier. The distance between the detector junction box and amplifier junction box can be up to 150 feet (50 meters). A remote mounting bracket is supplied.

### **Submersible Option**

If you are installing the meter in a vault, you should order the remote mount, submersible amplifier option. You must not install the amplifier inside a vault. This will eliminate any potential problems resulting from humidity or temporary flooding in the vault.

**NOTE:** The National Electronics Manufacturer's Association (NEMA) 6P enclosures are constructed for indoor or outdoor use to provide protection against access to hazardous parts; to provide a degree of protection against ingress of solid foreign objects and water (hose directed water and the entry of water during prolonged submersion at a limited depth); that provide an additional level of protection against corrosion and that will be undamaged by the external formation of ice on the enclosure.

## Protection Class

In order to fulfill requirements of the protection class, follow these guidelines:

### **⚠ CAUTION**

- **BODY SEALS NEED TO BE UNDAMAGED AND IN PROPER CONDITION.**
- **ALL OF THE BODY SCREWS NEED TO BE FIRMLY TIGHTENED.**
- **OUTER DIAMETERS OF THE USED WIRING CABLES MUST CORRESPOND TO CABLE INLETS (FOR M20 Ø 5...13 MM). IN CASES WHERE CABLE INLET IS NOT USED, PUT ON A DUMMY PLUG.**
- **TIGHTEN CABLE INLETS.**
- **IF POSSIBLE, LEAD CABLE AWAY DOWNWARDS. HUMIDITY CANNOT GET INTO CABLE INLET.**
- **WE NORMALLY DELIVER THE METER IN ACCORDANCE WITH PROTECTION CLASS IP 67. IF YOU HOWEVER REQUIRE A HIGHER PROTECTION CLASS, THE AMPLIFIER IS TO BE INSTALLED SEPARATELY FROM THE DETECTOR. IF REQUESTED, WE CAN ALSO DELIVER THE DETECTOR IN IP 68.**

### **⚠ ATTENTION**

- **LES JOINTS DE CORPS NE DOIVENT PAS ÊTRE ENDOMMAGÉS ET ÊTRE EN BON ÉTAT.**
- **TOUTES LES VIS DE CORPS DOIVENT ÊTRE FERMEMENT SERRÉES.**
- **LE DIAMÈTRE EXTÉRIEUR DES FILS DE CÂBLAGE UTILISÉS DOIVENT CORRESPONDRE AUX ENTRÉES DE CÂBLE (POUR M20 Ø 5... 13 MM). DANS LES CAS OÙ L'ENTRÉE DE CÂBLE N'EST PAS UTILISÉE, METTEZ UNE FICHE ISOLANTE.**
- **SERREZ LES ENTRÉES DE CÂBLE.**
- **SI CELA EST POSSIBLE, DIRIGEZ LE CÂBLE VERS LE BAS. ÉVITEZ QUE DE L'HUMIDITÉ NE PÉNÈTRE DANS L'ENTRÉE DE CÂBLE.**
- **LE COMPTEUR OFFERT EST NORMALEMENT CONFORME À LA CLASSE DE PROTECTION IP 67. CEPENDANT, SI VOUS EXIGEZ UNE CLASSE DE PROTECTION SUPÉRIEURE, L'AMPLIFICATEUR DOIT ÊTRE INSTALLÉ SÉPAREMENT DU DÉTECTEUR. SUR DEMANDE, LE DÉTECTEUR PEUT ÊTRE OFFERT EN IP 68.**

## METER GASKETS AND GROUNDING

Gasket and grounding requirements must be considered when determining the meter location, orientation and application.

### Meter/Pipeline Connection Gaskets

You must install gaskets (not provided) between the detector's isolating liner and the pipeline flange to ensure a proper and secure hydraulic seal. Use gaskets that are compatible with the fluid. Center each gasket on the flange to avoid flow restrictions or turbulence in the line.

During installation, do not use graphite or any electrically conductive sealing compound to hold the gaskets. This could compromise the accuracy of the measuring signal.

If you are using a grounding ring in the detector/pipeline connection, place the ring between two gaskets. (See "Pipelines with Cathodic Protection" on page 14.)

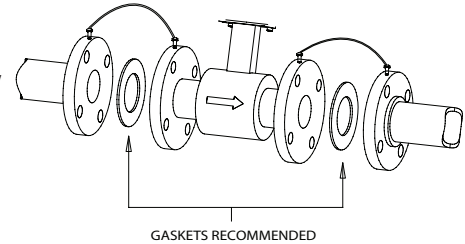

Figure 15: Meter/pipeline connection gaskets

### Meter Grounding

Process pipeline material can be either electrically conductive (metal) or not electrically conductive (made of or lined with PVC, fiberglass or concrete).

*It is essential that the mag meter amplifier's input ground (zero voltage reference) be electrically connected to the liquid media and to a good, solid earth ground reference.*

### Conductive Pipe Grounding

To achieve an adequate ground, the meter body **MUST** be electrically connected to the liquid media. The mag meter flanges are provided with grounding bolts for this purpose.

If the pipe material is electrically conductive, simply install grounding straps between these grounding bolts and the mating flanges.

To ensure a good electrical connection at the mating flanges, we recommend that you drill and tap the flanges and install a grounding screw (not provided).

These grounding straps must be copper wire, at least 12 AWG size. They must be connected on both sides (inlet and outlet) of the detector and to a local, earth ground.

### Pipelines with Cathodic Protection

As for pipelines with cathodic protection, install meter potential-free. No electric connection from the meter to the pipeline system may exist and power supply is to be provided via isolating transformer.

#### **CAUTION**

**USE GROUNDING ELECTRODES (GROUNDING RINGS ALSO NEED TO BE INSTALLED ISOLATED FROM THE PIPELINE SYSTEM).**

#### **ATTENTION**

**UTILISEZ LES ÉLECTRODES DE MISE À LA TERRE (LES ANNEAUX DE MISE À LA TERRE DOIVENT ÊTRE INSTALLÉES À PARTIR DU SYSTÈME DE CONDUITES).**

Observe national rules for potential-free installations.

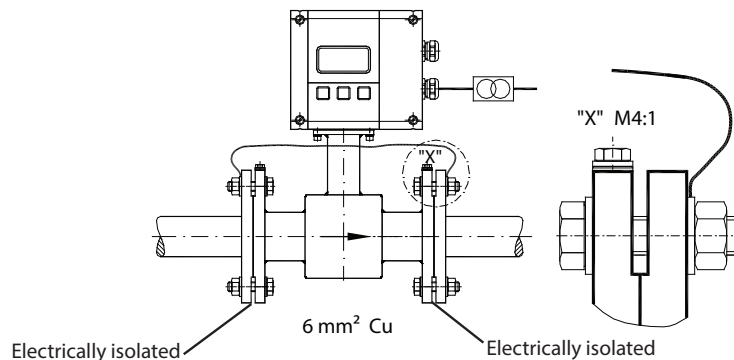

Figure 16: Cathodic protection

## Non-Conductive Pipe Grounding

If the process pipe is not electrically conductive (PVC, fiberglass, cement-lined pipes or any other non-conductive material) and the meter was not originally ordered with an optional grounding electrode, you must install a pair of grounding rings between the mating flanges at both ends of the meter. See the following illustration.

In this case, the grounding straps should be connected to both of the grounding rings and to a good, solid earth ground. Grounding rings are available in stainless steel. If your fluid is too aggressive for stainless steel, order a meter with the optional grounding electrode in a material compatible with the fluid.

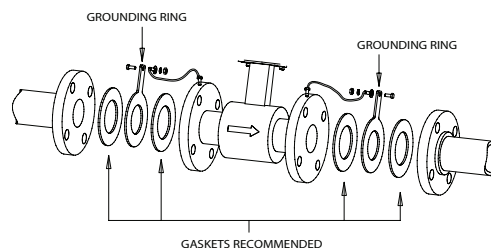

Figure 17: Non-conductive pipe grounding

## POWER CONNECTIONS

### Wiring Safety

#### ⚠ WARNING

**AT INSTALLATION, BE SURE TO COMPLY WITH THE FOLLOWING REQUIREMENTS:**

- Disconnect power to the unit before attempting any connection or service to the unit.
- Do not bundle or route signal lines with power lines.
- Keep all lines as short as possible.
- Use twisted pair shielded wire for all output wiring.
- Observe all applicable local electrical codes.

#### ⚠ AVERTISSEMENT

**LORS DE L'INSTALLATION, ASSUREZ-VOUS DE RESPECTER LES EXIGENCES SUIVANTES :**

- Débranchez l'appareil avant d'essayer toute connexion ou tout service à l'appareil.
- Ne pas regrouper ou acheminer les lignes de signaux aux lignes électriques.
- Gardez toutes les lignes aussi courtes que possible.
- Utilisez un câble blindé à paire torsadée pour tout le câblage de sortie.
- Respectez tous les codes locaux applicables en matière d'électricité.

## Opening the M1000 Cover

The M1000 amplifier's design lets you open the cover without completely removing it.

Follow these steps:

1. Completely remove the top two screws from the amplifier using a blade/slotted screwdriver.
  2. Loosen both of the bottom screws so that the round head of each screw clears the top face of the cover.
  3. Pull down the cover to the open position.
- For the 2 x M20 cable inlets, use only flexible electric cables.
  - Use separate cable inlets for auxiliary power, signal and input/output cables.



Figure 18: Remove two screws



Figure 19: Open the cover

## Auxiliary Power

### ⚠ CAUTION

**TO PREVENT ACCIDENTS, CONNECT MAIN POWER ONLY AFTER ALL OTHER WIRING HAS BEEN COMPLETED.**

### ⚠ ATTENTION

**AFIN D'ÉVITER LES ACCIDENTS, BRANCHEZ L'ALIMENTATION PRINCIPALE SEULEMENT UNE FOIS TOUT LE CÂBLAGE COMPLÉTÉ.**

### Take national applicable rules into account.

- Observe type plate (mains voltage and frequency)
  - Equipment shall be provided with a external means for disconnecting it from each operating energy supply source. The disconnecting means shall disconnect all current-carrying conductors.
1. Open the cover (see "*Opening the M1000 Cover*" on page 16).
  2. Push the auxiliary power cable through the upper cable inlet.
  3. Connect as shown in *Figure 20*.
  4. Close the cover and tighten the screws.

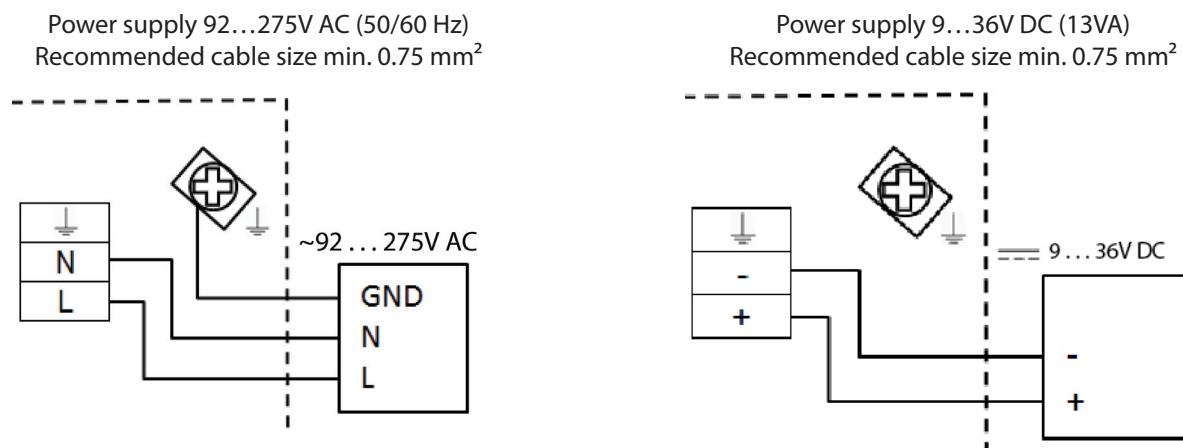

Figure 20: Auxiliary power connection



## Remote Version

### CAUTION

CONNECT OR REMOVE THE SIGNAL CONNECTION CABLE ONLY WHEN THE UNIT HAS BEEN SWITCHED OFF.

### ATTENTION

BRANCHEZ OU RETIREZ LE CÂBLE DU SIGNAL DE CONNEXION UNIQUEMENT LORSQUE L'APPAREIL EST ÉTEINT.

#### Connection to the Measuring Amplifier

1. Open the cover (see "Opening the M1000 Cover" on page 16).
2. Push the signal cable through the lower cable inlet.
3. Connect as shown in Figure 21.
4. Close the cover and tighten the screws and the wire gland.

#### Connection to the Junction Box

1. Open the junction box.
2. Push the signal cable through the upper cable inlet.
3. Connect as shown in Figure 21.
4. Close the cover and tighten the screws and wire gland.

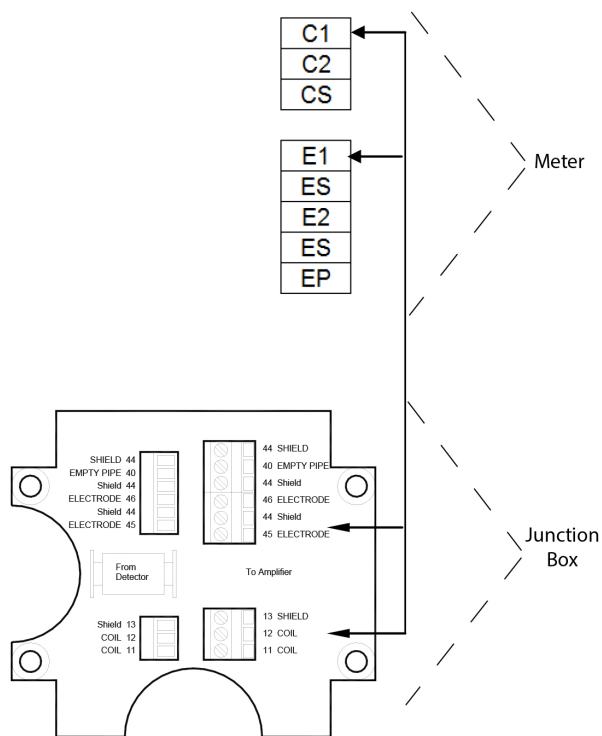

Figure 21: Remote version connection

Junction Box	M1000	Description	Wire Color
11	C1	Coil 1	Green
12	C2	Coil 2	Yellow
13	CS	Main shield	Yellow/Green
45	E1	Electrode 1	White
44*	ES	Electrode shield	Black
46	E2	Electrode 2	Brown
40	EP	Empty pipe	Pink
44*	ES	Empty pipe shield	Black

\* Connections with number 44 are on the same potential.

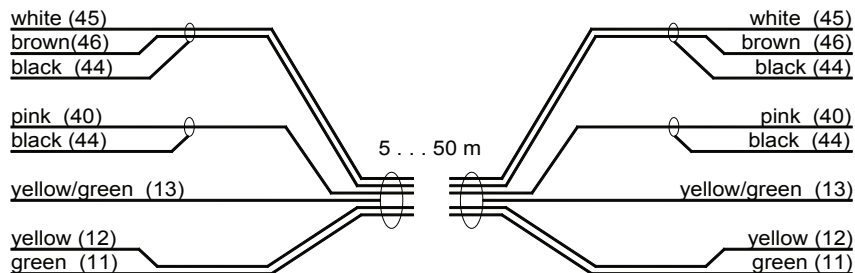

Figure 22: Signal cable specification

## Configuring Input/Output (I/O)

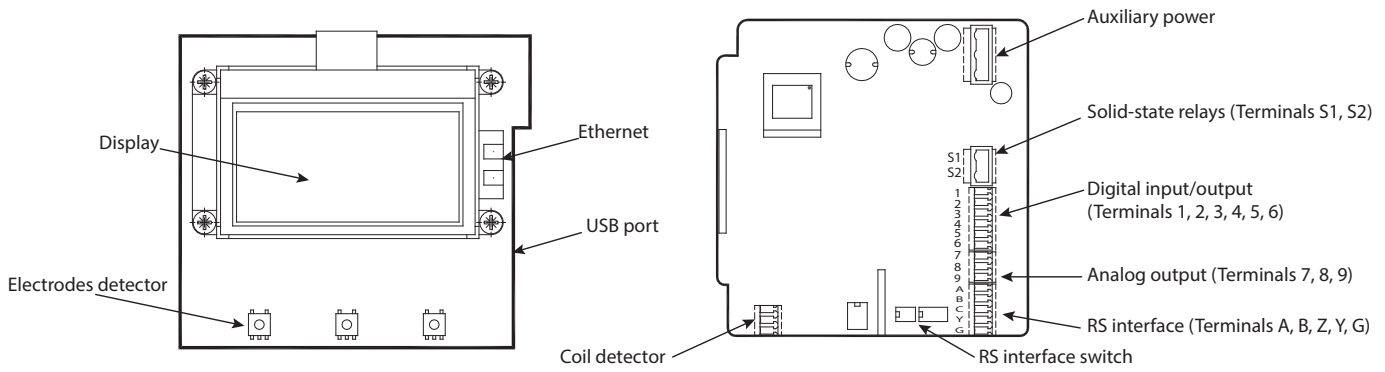

Figure 23: Configuring I/O

Input/Output	Description	Terminal			
<b>Analog Output</b>	0...20 mA 4...20 mA 0...10 mA	7 (+) 8 (-) 9 (GND)			
<b>Digital Output</b>					
<b>1</b>	Open collector max. 10 kHz • Passive max. 32V DC, <100 Hz 100 mA, >100 Hz 20 mA • Active 24V DC, 20 mA (can be powered by analog output if not used)	3 (-) 4 (+)			
<b>2</b>	Open collector max. 10 kHz • Passive max. 32V DC, <100 Hz 100 mA, >100 Hz 20 mA • Active 24V DC, 20 mA (can be powered by analog output if not used)	1 (-) 2 (+)			
	Solid-state relays max. 230V AC, 500 mA, max 1 Hz (Function is linked with Output 2)	S1 and S2			
<b>Digital Input</b>	5...30V DC	5 (-) and 6 (+)			
<b>RS-Interfaces</b>	RS-232, RS-485 and RS-422 with Modbus RTU. Mode can be configured by DIP switches when termination is ON or OFF.	<b>Connector Label</b>			
		<b>RS Interfaces</b>			
		<b>422</b>	<b>232</b>	<b>485</b>	
		<b>A</b>	A	RxD	—
		<b>B</b>	B	—	—
<b>Z</b>	Z	TxD	B		
<b>Y</b>	Y	—	A		
<b>G</b>	G (GND)				
<b>USB</b>	USB Device CDC (Host Mass Storage)	Micro USB			
<b>Ethernet</b>	Ethernet interface connection	RJ45 socket			

**⚠ CAUTION**

USE SEPARATE CABLE INLETS FOR CABLES CONNECTED TO THE SOLID-STATE RELAY OUTPUT AND CABLES CONNECTED TO THE OTHER INPUT/OUTPUTS.

IN MULTIPHASE NETS, SOLID-STATE RELAY SHOULD HANDLE ONLY THE SAME PHASE THAT IS USED FOR POWERING THE METER.

**⚠ ATTENTION**

UTILISEZ DES ENTRÉES DE CÂBLE DISTINCTES POUR LES CÂBLES BRANCHÉS À LA SORTIE DES RELAIS STATIQUES ET AUX CÂBLES BRANCHÉS AUX AUTRES ENTRÉES OU SORTIES.

POUR LES FILETS MULTIPHASES, LE RELAIS STATIQUE NE DEVRAIT SERVIR QUE LA MÊME PHASE UTILISÉE POUR ALIMENTER LE COMPTEUR

## M1000 MAIN MENU PROGRAMMING OPTIONS

### Screen Layout

The following M1000 programming options are available from the *Main Menu*:

- Meter Setup
- Measurement
- Input/Outputs
- Totals
- Communications
- Miscellaneous
- Information
- Pin

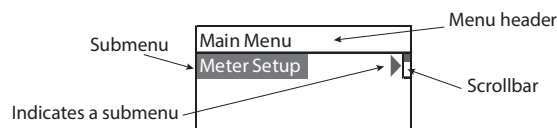

Figure 24: Screen layout

### Function Buttons

All M1000 programming is accomplished using the three function buttons located on the front of the amplifier. Screen navigation, digit, and parameter selection is performed by pressing a combination of these three buttons.







Press ▲ to scroll through the menu screens or move downward in a list.

Press ▲ or **EXIT SAVE** button to enter a menu or move to the next submenu. The scrollbar on the upper right shows your position in the list. Press **EXIT SAVE** to go back from a submenu to the upper menu.

To select parameters or values from a list in a menu point, first press ▲ until the parameter or value is displayed then press **EXIT SAVE** to select it. The current number in the list is marked by a little black square to the left of the number. For example, ■ DN 50.

To change a parameter, press ► to enter the menu. The first character flashes. Press ▲ to change the value. Once you have changed the value, press ► to move to the next value. Press **EXIT SAVE** to confirm the new value.

### Status Icons

-  Communication interface is activated
-  Meter is unlocked
-  Error message
-  Empty pipe detection

## Setting Personal Identification Numbers (PINs)

The M1000 offers three levels of access to the individual menus: **Administrative**, **Service** and **User** level.

The applicable security level for each menu option is indicated as follows:



Administrative



Service



User

The M1000 security feature allows the option to restrict access to the meter by way of a 6-digit Personal Identification Number (PIN). No PINs are set at the factory. The system administrator can set up a single PIN for each of the three different levels of access:

- **Administration** – allows access to all M1000 menu configuration screens.
- **Service** – allows access to service-level and user-level menu configuration screens.
- **User** – allows access only to user-level menu configuration screens.

1. To activate password protection, navigate to the *PIN* menu. Set *Control* to **ON**.

2. Enter Login with the password 000000.

3. Return to the *PIN* menu and enter [User], [Service] and [Admin] password.

Once the password protection has been activated, enter your PIN under *Login*.

**NOTE:** The *Login* screen is available only after *Control* has been set to **ON**.

The lock open symbol  appears.

The PIN grants you access to either Administrator, Service or User level with the respective access rights (marked with A, S and U in this manual). You can now move to the menu and enter your parameters.

Without a login, you can read all parameters, but cannot change them.

### Logging In

To change any parameter in the mag meter, the PIN entered must provide the proper security privilege required by the parameter.

To enter a PIN, go to the *Login* menu and enter the PIN for the required security level.

Once you are properly logged in, the unlocked icon appears on the meter display.

**NOTE:** A **PIN Error** message displays if the incorrect PIN is entered.

### Logging Out

To log out, enter an unknown PIN, then press **EXIT SAVE**.

## Menu Hierarchy Structure

**Main\_Menu** → **Meter Setup** → Calibration  
Scale Factor  
Power Line Frequency  
Excitation Freq  
Empty Pipe Detect

**Measurements** → Flow Unit  
Totalizer Unit  
Full Scale Flow  
Low Flow Cutoff  
Flow Direction  
Filter

**Input/Outputs** → Analog Output  
Digital Input  
Digital Outputs  
Simulation

**Totals** → Clear T2









**Communications** → Interface  
Modbus  
M-Bus  
HART  
Ethernet  
ADE

**Miscellaneous** → Log  
Power Up  
Settling Time  
Language  
Date  
Time  
EEPROM  
Polar Voltage  
Display Rotation  
Contrast  
Datalog Period





**Info** → Serial Number  
Version  
Compilation Date  
OtpCrc  
AppCrc





**PIN** → Control  
User  
Service  
Admin

## Meter Setup Menu

Meter Setup										
<b>Calibration</b>	<b>Diameter</b> 	This parameter is set at the factory. In the event the amplifier is replaced, verify that the pipe diameter matches the installed pipe size.								
	<b>Detector Factor</b> 	This parameter is set at the factory. This factor compensates for accuracy error as a result of the installed detector. In the event the amplifier is replaced, this parameter must be reprogrammed with the original detector zero.								
	<b>Detector Zero</b> 	This parameter is set at the factory. This parameter compensates for accuracy error as a result of the installed detector. If accuracy adjustment of the meter is required, refer to the scale factor.								
	<b>Amplifier Factor</b>	This parameter is set at the factory and is Read Only. This electronic calibration factor compensates for accuracy error as a result of the installed amplifier.								
	<b>Coil Current</b>	This parameter (coil current to the detector) is set at the factory and is Read Only. This factor compensates for accuracy error as a result of the installed amplifier.								
<b>Scale Factor</b> 	Changing the scale factor lets you adjust the meter's accuracy without disturbing parameters set by the factory. You can tune the meter to meet changing application requirements in a range of $\pm 5\%$ (0.95 to 1.05).									
<b>Power Line Frequency</b> 	For optimum operation of the meter, set Power Line Frequency to 50 Hz or 60 Hz in this menu at operating location.									
<b>Excitation Frequency</b> 	<p>This parameter is set at the factory. This value shows in which frequency the meter's coils are operated. Supported frequencies are dependent on the configured power line frequency and meter's size.</p> <table border="1" data-bbox="386 1178 704 1289"> <thead> <tr> <th>50 Hz</th> <th>60 Hz</th> </tr> </thead> <tbody> <tr> <td>3.125 Hz</td> <td>3.75 Hz</td> </tr> <tr> <td>6.25 Hz</td> <td>7.5 Hz</td> </tr> <tr> <td>12.5 Hz</td> <td>15 Hz</td> </tr> </tbody> </table> <p><b>NOTE:</b> When selecting excitation frequency, make sure to always observe that the ratio in respect of power frequency is integer.</p>		50 Hz	60 Hz	3.125 Hz	3.75 Hz	6.25 Hz	7.5 Hz	12.5 Hz	15 Hz
50 Hz	60 Hz									
3.125 Hz	3.75 Hz									
6.25 Hz	7.5 Hz									
12.5 Hz	15 Hz									
<b>Empty Pipe Detection</b> 	<b>ON/OFF</b> 	When set to ON, an Empty Pipe condition indicates to the outputs that the meter is not completely filled. When set to OFF, empty pipe conditions are not detected.								
	<b>Threshold</b> 	Threshold value for empty pipe detection. For liquids with lower conductivity or long cables the threshold value must be increased. The actual value can be monitored in the next menu "measured".								
	<b>Measured</b>	Measures the real empty pipe value. This parameter is Read Only.								



## Measurement Menu





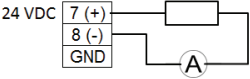
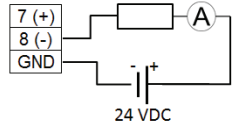

<b>Measurement</b>																																									
<b>Flow Unit</b> 	<p>Flow Units let you select among the Flow Units listed below. Flow units are automatically converted into the selected unit.</p> <table border="1" style="margin-left: auto; margin-right: auto;"> <thead> <tr> <th><i>Display</i></th> <th><i>Flow Unit</i></th> <th><i>Display</i></th> <th><i>Flow Unit</i></th> </tr> </thead> <tbody> <tr> <td>L/s</td> <td>Liters/Second</td> <td>gal/s</td> <td>Gallons/Second</td> </tr> <tr> <td>L/min</td> <td>Liters/Minute</td> <td>gal/min</td> <td>Gallons/Minute</td> </tr> <tr> <td>L/h</td> <td>Liters/Hour</td> <td>gal/h</td> <td>Gallons/Hour</td> </tr> <tr> <td>m<sup>3</sup>/s</td> <td>Cubic Meters/Second</td> <td>MG/d</td> <td>MillionGallons/Day</td> </tr> <tr> <td>m<sup>3</sup>/min</td> <td>Cubic Meters/Minute</td> <td>IG/s</td> <td>ImperialGallons/Second</td> </tr> <tr> <td>m<sup>3</sup>/h</td> <td>Cubic Meters/Hour</td> <td>IG/min</td> <td>ImperialGallons/Minute</td> </tr> <tr> <td>ft<sup>3</sup>/s</td> <td>Cubic Feet/Second</td> <td>IG/h</td> <td>ImperialGallons/Hour</td> </tr> <tr> <td>ft<sup>3</sup>/m</td> <td>Cubic Feet/Minute</td> <td>oz/min</td> <td>Ounce/Minute</td> </tr> <tr> <td>ft<sup>3</sup>/h</td> <td>Cubic Feet/Hour</td> <td>bbl/min</td> <td>Barrel/Minute</td> </tr> </tbody> </table>	<i>Display</i>	<i>Flow Unit</i>	<i>Display</i>	<i>Flow Unit</i>	L/s	Liters/Second	gal/s	Gallons/Second	L/min	Liters/Minute	gal/min	Gallons/Minute	L/h	Liters/Hour	gal/h	Gallons/Hour	m <sup>3</sup> /s	Cubic Meters/Second	MG/d	MillionGallons/Day	m <sup>3</sup> /min	Cubic Meters/Minute	IG/s	ImperialGallons/Second	m <sup>3</sup> /h	Cubic Meters/Hour	IG/min	ImperialGallons/Minute	ft <sup>3</sup> /s	Cubic Feet/Second	IG/h	ImperialGallons/Hour	ft <sup>3</sup> /m	Cubic Feet/Minute	oz/min	Ounce/Minute	ft <sup>3</sup> /h	Cubic Feet/Hour	bbl/min	Barrel/Minute
<i>Display</i>	<i>Flow Unit</i>	<i>Display</i>	<i>Flow Unit</i>																																						
L/s	Liters/Second	gal/s	Gallons/Second																																						
L/min	Liters/Minute	gal/min	Gallons/Minute																																						
L/h	Liters/Hour	gal/h	Gallons/Hour																																						
m <sup>3</sup> /s	Cubic Meters/Second	MG/d	MillionGallons/Day																																						
m <sup>3</sup> /min	Cubic Meters/Minute	IG/s	ImperialGallons/Second																																						
m <sup>3</sup> /h	Cubic Meters/Hour	IG/min	ImperialGallons/Minute																																						
ft <sup>3</sup> /s	Cubic Feet/Second	IG/h	ImperialGallons/Hour																																						
ft <sup>3</sup> /m	Cubic Feet/Minute	oz/min	Ounce/Minute																																						
ft <sup>3</sup> /h	Cubic Feet/Hour	bbl/min	Barrel/Minute																																						
<b>Totalizer Unit</b> 	<p>This parameter establishes the units of measure for the totalizers.</p> <table border="1" style="margin-left: auto; margin-right: auto;"> <thead> <tr> <th><i>Display</i></th> <th><i>Totalizer Unit</i></th> <th><i>Display</i></th> <th><i>Totalizer Unit</i></th> </tr> </thead> <tbody> <tr> <td>L</td> <td>Liters</td> <td>MG</td> <td>Million Gallons</td> </tr> <tr> <td>hL</td> <td>Hectoliter</td> <td>IG</td> <td>Imperial Gallons</td> </tr> <tr> <td>m<sup>3</sup></td> <td>Cubic Meters</td> <td>bbl</td> <td>Barrel</td> </tr> <tr> <td>ft<sup>3</sup></td> <td>Cubic Feet</td> <td>oz</td> <td>Fluid Ounces</td> </tr> <tr> <td>gal</td> <td>U.S. Gallons</td> <td>ac/ft</td> <td>Acre per foot</td> </tr> </tbody> </table>	<i>Display</i>	<i>Totalizer Unit</i>	<i>Display</i>	<i>Totalizer Unit</i>	L	Liters	MG	Million Gallons	hL	Hectoliter	IG	Imperial Gallons	m <sup>3</sup>	Cubic Meters	bbl	Barrel	ft <sup>3</sup>	Cubic Feet	oz	Fluid Ounces	gal	U.S. Gallons	ac/ft	Acre per foot																
<i>Display</i>	<i>Totalizer Unit</i>	<i>Display</i>	<i>Totalizer Unit</i>																																						
L	Liters	MG	Million Gallons																																						
hL	Hectoliter	IG	Imperial Gallons																																						
m <sup>3</sup>	Cubic Meters	bbl	Barrel																																						
ft <sup>3</sup>	Cubic Feet	oz	Fluid Ounces																																						
gal	U.S. Gallons	ac/ft	Acre per foot																																						
<b>Full Scale Flow</b> 	<p>This parameter sets the maximum flow the system is expected to measure. This parameter has influence on other system parameters like analog output or low flow cutoff.</p> <p>In terms of flow velocity, the meter's range is 0.3...12 m/sec.</p> <p>The full scale flow is valid for both flow directions.</p> <p><b>NOTE:</b> Note: If the flow rate exceeds the full scale setting, an error message indicates that the configured full scale range has been exceeded.</p>																																								
<b>Low Flow Cutoff</b> 	<p>Low Flow Cutoff defines the threshold at which flow measurement will be forced to zero. The cutoff value can be from 0% to 10% of the full scale flow. Increasing this threshold will help prevent false readings during "no flow" conditions possibly caused by vibrations or liquid fluctuations.</p>																																								
<b>Flow Direction</b> 	<p>Flow direction lets you set the meter to measure forward flow only (unidirectional) or both forward and reverse flow (bidirectional).</p> <p>Unidirectional means that the flow is totalized in only one direction. The flow direction is indicated by the arrow printed on the detector label. In this mode, the two totalizers T1+ and T2+ can be used as totalizers and resettable day counter.</p> <p>Bidirectional means the flow is totalized in both directions. The totalizer T1+ and T2+ registers forward flow and the totalizer T1- and T2- in reverse flow direction. The net totalizer T1N and T2N shows the difference between T+ and T-.</p> <p>A change of the flow direction can be signaled by the digital outputs.</p>																																								

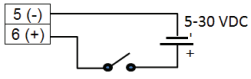
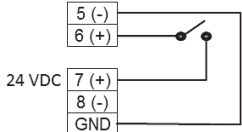



<b>Measurement</b>																
<b>Filter</b> 	<b>Median</b> 	The Median Filter (MDN) reduces noise on the measuring signal. The filter level can be adjusted from 7 up to 13 or switched off.														
	<b>Moving Average</b> 	Moving average filter (MAV) smooths out short-term fluctuations. The value can be adjusted from 1 to 200 measuring periods. The delay is calculated: Delay [s] = ( MAV – 1) x T The time (T) is given by the adjusted excitation frequency of the meter. <table border="1" style="margin-left: 20px; margin-top: 10px;"> <thead> <tr> <th style="text-align: center;">Excitation frequency [Hz]</th> <th style="text-align: center;">T = Time for filter delay (s)</th> </tr> </thead> <tbody> <tr> <td style="text-align: center;">15</td> <td style="text-align: center;">0.03333</td> </tr> <tr> <td style="text-align: center;">12.5</td> <td style="text-align: center;">0.040</td> </tr> <tr> <td style="text-align: center;">7.5</td> <td style="text-align: center;">0.06666</td> </tr> <tr> <td style="text-align: center;">6.25</td> <td style="text-align: center;">0.080</td> </tr> <tr> <td style="text-align: center;">3.75</td> <td style="text-align: center;">0.13333</td> </tr> <tr> <td style="text-align: center;">3.125</td> <td style="text-align: center;">0.160</td> </tr> </tbody> </table> For example: MAV = 20 and the excitation frequency is 6.25 Hz means T=0.08 s, the delay is 1.52 s.	Excitation frequency [Hz]	T = Time for filter delay (s)	15	0.03333	12.5	0.040	7.5	0.06666	6.25	0.080	3.75	0.13333	3.125	0.160
	Excitation frequency [Hz]	T = Time for filter delay (s)														
15	0.03333															
12.5	0.040															
7.5	0.06666															
6.25	0.080															
3.75	0.13333															
3.125	0.160															
<b>Display</b> 	Moving average filter smooths out short-term fluctuations only for the display. The value can be adjusted from 1 to 200 measuring periods. For calculation of the delay see <b>Moving Average</b> above.															

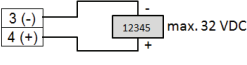
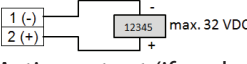
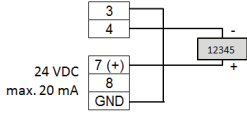
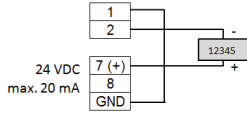

## Input/Outputs Menu

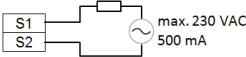
Input/Outputs						
<p><b>Analog Output</b></p>	<p><b>Range</b></p> <p></p>	<p>This parameter establishes the range of the analog output signal: 0...100% (= full scale). The following current ranges are available to you:</p> <table border="1" style="margin-left: 20px;"> <thead> <tr> <th>Current Output</th> </tr> </thead> <tbody> <tr> <td>0...20 mA</td> </tr> <tr> <td>4...20 mA</td> </tr> <tr> <td>0...10 mA</td> </tr> </tbody> </table> <p>Analog output active</p>  <p>Analog output passive</p>  <p><b>NOTE:</b> When an error message is displayed, the current is set according the programming of the Alarm Mode below. When you select <i>bidirectional</i> operation, you can signal flow direction via digital outputs.</p>	Current Output	0...20 mA	4...20 mA	0...10 mA
Current Output						
0...20 mA						
4...20 mA						
0...10 mA						
<p><b>Alarm Mode</b></p>	<p></p>	<p>This parameter configures the behavior of the analog output during alarm conditions. Three options exist for this parameter: OFF, LOW and HIGH.</p> <p><b>OFF:</b> Analog signal is based on flow rate and always within the configured range.</p> <p><b>LOW:</b> During alarm conditions, the analog signal will be 2 mA less than the configured lower range. (only on 4...20 mA range).</p> <p><b>HIGH:</b> During alarm conditions, the analog signal will be 2 mA more than the configured upper range.</p> <p>For example, if the analog range is 4...20 mA and the alarm mode is set to HIGH, then during a full scale flow alarm condition, the analog output current will be 22 mA.</p>				
<p><b>Digital Input</b></p> <p></p>	<p>Digital input lets you reset totalizers (Remote reset), or interrupt flow measurement (PosZeroReturn).</p> <ul style="list-style-type: none"> <li>• Remote Reset – Clears totalizer T2 (unidirectional)</li> <li>• Pos Zero Return – Forces flow rate to zero (does not totalize)</li> </ul> <p>Input switching is provided by applying an external potential of 5...30V DC</p>  <p>or by an internal voltage source of 24V DC (Analog output if not used).</p> 					

<b>Inputs/Outputs</b>		
<p><b>Digital Outputs</b></p> <p><i>(continued on next page)</i></p>	<p><b>Pulse Width</b></p> 	<p>This parameter establishes the “On” duration of the transmitted pulse. The configurable range is 0...2000 ms. If 0 ms is configured, pulse width is automatically adapted depending on pulse frequency (pulse/pause ratio 1:1). During the configuration the program checks if pulses/unit and pulse width are in accordance with full scale defined, if not an error alarm is displayed. In case of an error alarm, scale, pulse width or full scale need to be adapted.</p>
	<p><b>Pulse/Unit</b></p> 	<p>The Pulses/Unit parameter lets you set how many pulses per unit of measure will be transmitted. The maximum output frequency of 10,000 pulses/sec. (10 KHZ) must not be exceeded.</p> <p>For example, assuming the unit of measure is gallons:</p> <ul style="list-style-type: none"> <li>Setting the Pulses/Unit to 1 will transmit 1 pulse every gallon</li> <li>Setting the Pulses/Unit to 0.01 will transmit 1 pulse every 100 gallons</li> </ul> <p>You must configure pulses/unit if the function of the selected output is to be forward, reverse or AMR pulse.</p>
	<p><b>Frequency</b></p> 	<p>This parameter establishes to define the digital output as frequency output. The full scale frequency configurable range is 0.01...10,000 Hz.</p>
	<p><b>Set Min./Max.</b></p> 	<p>The Flow Set Point (min, max) establishes as a percentage of full scale flow, the threshold at which the output alarm will be activated. You can freely select thresholds in 1% steps. Flow rates below/above the threshold will activate the output alarm.</p>
	<p><b>Preset Amount</b></p> 	<p>Preset amount lets you set the reset value for the associated PS totalizer when the digital input is set to Batch Reset. You can configure preset amount in the adjusted volume unit.</p> <p>Preset amount is counted down from the configured value to 0 and a digital output shows that the preset amount has been reached.</p>
	<p><b>Out 1 Function</b> <b>Out 2 Function</b></p>  <p><i>(continued on next page)</i></p>	<p>From the sub-menus <i>Out 1 Function</i> and <i>Out 2 Function</i>, you can configure functional operation of the 2 digital outputs. For example, you can select “forward pulse” for the digital output and define the pulses-per-totalizer unit via “pulse scale”.</p> <p>The two outputs can be operated as open collector passively or actively.</p> <p>Passive output:</p>   <p>Active output (if analog output is not used):</p>  

<b>Inputs/Outputs</b>																																																										
<b>Digital Outputs</b> (continued)	<b>Out 1 Function</b> <b>Out 2 Function</b>  (continued)	<b>Solid-State Relay</b> The solid-state relay is functionally linked with Output 2. See the table below. 																																																								
	The following functions can be selected for the Outputs 1 to 2 as well as for the solid-state relay. The solid-state relay function is linked with the function of Output 2.																																																									
	<table border="1" style="width: 100%; border-collapse: collapse;"> <thead> <tr> <th style="width: 20%;">Function</th> <th style="width: 60%;">Meaning</th> <th style="width: 10%;">Out1</th> <th style="width: 10%;">Out2 / Solid-State Relay</th> </tr> </thead> <tbody> <tr> <td>Off</td> <td>Digital output is switched off.</td> <td style="text-align: center;">X</td> <td style="text-align: center;">X</td> </tr> <tr> <td>Test</td> <td>Used only for the Verification Device.</td> <td style="text-align: center;">X</td> <td style="text-align: center;">X</td> </tr> <tr> <td>Comparator</td> <td style="text-align: center;">TBD</td> <td style="text-align: center;">X</td> <td style="text-align: center;">X</td> </tr> <tr> <td>Empty Pipe Error</td> <td>Indicates when a pipe is empty.</td> <td style="text-align: center;">X</td> <td style="text-align: center;">X</td> </tr> <tr> <td>Error Alarm</td> <td>Indicates a meter error condition.</td> <td style="text-align: center;">X</td> <td style="text-align: center;">X</td> </tr> <tr> <td>Forward Pulses</td> <td>Generates pulses during forward flow conditions.</td> <td style="text-align: center;">X</td> <td style="text-align: center;">X</td> </tr> <tr> <td>Reverse Pulses</td> <td>Generates pulses during reverse flow conditions.</td> <td style="text-align: center;">X</td> <td style="text-align: center;">X</td> </tr> <tr> <td>Direction</td> <td>Indicates current flow direction.</td> <td style="text-align: center;">X</td> <td style="text-align: center;">X</td> </tr> <tr> <td>Loopback</td> <td>Shows the status of the digital input.</td> <td style="text-align: center;">X</td> <td style="text-align: center;">X</td> </tr> <tr> <td>Min./Max. Alarm</td> <td>Establishes, as a percentage of full scale flow, the threshold at which the output alarm will be activated. Flow rates below or above the threshold will activate the output alarm.</td> <td style="text-align: center;">X</td> <td style="text-align: center;">X</td> </tr> <tr> <td>Frequency</td> <td style="text-align: center;">TBD</td> <td style="text-align: center;">X</td> <td style="text-align: center;">X</td> </tr> <tr> <td>Rotary Encoder</td> <td style="text-align: center;">TBD</td> <td style="text-align: center;">X</td> <td style="text-align: center;">X</td> </tr> <tr> <td>Preset</td> <td>Indicates when a preset batch amount has been realized.</td> <td style="text-align: center;">X</td> <td style="text-align: center;">X</td> </tr> </tbody> </table>			Function	Meaning	Out1	Out2 / Solid-State Relay	Off	Digital output is switched off.	X	X	Test	Used only for the Verification Device.	X	X	Comparator	TBD	X	X	Empty Pipe Error	Indicates when a pipe is empty.	X	X	Error Alarm	Indicates a meter error condition.	X	X	Forward Pulses	Generates pulses during forward flow conditions.	X	X	Reverse Pulses	Generates pulses during reverse flow conditions.	X	X	Direction	Indicates current flow direction.	X	X	Loopback	Shows the status of the digital input.	X	X	Min./Max. Alarm	Establishes, as a percentage of full scale flow, the threshold at which the output alarm will be activated. Flow rates below or above the threshold will activate the output alarm.	X	X	Frequency	TBD	X	X	Rotary Encoder	TBD	X	X	Preset	Indicates when a preset batch amount has been realized.	X
Function	Meaning	Out1	Out2 / Solid-State Relay																																																							
Off	Digital output is switched off.	X	X																																																							
Test	Used only for the Verification Device.	X	X																																																							
Comparator	TBD	X	X																																																							
Empty Pipe Error	Indicates when a pipe is empty.	X	X																																																							
Error Alarm	Indicates a meter error condition.	X	X																																																							
Forward Pulses	Generates pulses during forward flow conditions.	X	X																																																							
Reverse Pulses	Generates pulses during reverse flow conditions.	X	X																																																							
Direction	Indicates current flow direction.	X	X																																																							
Loopback	Shows the status of the digital input.	X	X																																																							
Min./Max. Alarm	Establishes, as a percentage of full scale flow, the threshold at which the output alarm will be activated. Flow rates below or above the threshold will activate the output alarm.	X	X																																																							
Frequency	TBD	X	X																																																							
Rotary Encoder	TBD	X	X																																																							
Preset	Indicates when a preset batch amount has been realized.	X	X																																																							
<b>Out Type 1</b> 	This parameter lets you set the output switch to normally open or normally closed. If normally open is selected, the output switch is open (no current) when the output is inactive, and closed (current flows) when the output is active. If normally closed is selected, the output switch is closed (current flows) when the output is inactive, and open (no current) when the output is active.																																																									
<b>Out Type 2</b> 	This parameter lets you set the output switch to normally open or normally closed. If normally open is selected, the output switch is open (no current) when the output is inactive, and closed (current flows) when the output is active. If normally closed is selected, the output switch is closed (current flows) when the output is inactive, and open (no current) when the output is active.																																																									
<b>Simulation</b> 	Flow Simulation provides analog and digital output simulation based on a percentage of the full scale flow in cases where no real flow is occurring. The range of simulation is -100...100% in steps of 10% of the full scale flow. This function still remains active once you have left the menu. It is necessary to set it to OFF to deactivate it. If the simulation is still active, the letter "S" will be displayed in the measuring mode.																																																									

**Totals Menu**

<b>Totals</b>	
<b>Clear T2</b> 	The unidirectional Totalizer T2 is reset within the menu manager.

## Communication Menu

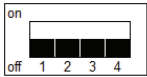
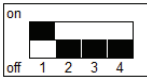
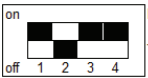
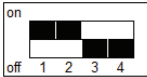
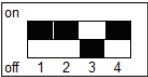
<b>Communication: Port Settings</b>																													
<b>Interfaces</b>	<b>Modbus RTU</b>	<p>RS-232, RS-485 and RS-422 with Modbus RTU.</p> <table border="1" style="margin-left: auto; margin-right: auto;"> <thead> <tr> <th rowspan="2">Connector Label</th> <th colspan="3">RS Interfaces</th> </tr> <tr> <th>422</th> <th>232</th> <th>485</th> </tr> </thead> <tbody> <tr> <td>A</td> <td>A</td> <td>RxD</td> <td>—</td> </tr> <tr> <td>B</td> <td>B</td> <td>—</td> <td>—</td> </tr> <tr> <td>Z</td> <td>Z</td> <td>TxD</td> <td>B</td> </tr> <tr> <td>Y</td> <td>Y</td> <td>—</td> <td>A</td> </tr> <tr> <td>G</td> <td colspan="3">G (GND)</td> </tr> </tbody> </table> <p>See <i>Figure 23</i> on page 18 for wiring diagram.</p> <p>Mode can be configured by DIP switches also if Termination is ON or OFF.</p> <div style="display: flex; flex-wrap: wrap; justify-content: space-around;"> <div style="text-align: center;">  <p>RS 232</p> </div> <div style="text-align: center;">  <p>RS 422 Term. OFF</p> </div> <div style="text-align: center;">  <p>RS 422 Term. ON</p> </div> <div style="text-align: center;">  <p>RS 485 Term. OFF</p> </div> <div style="text-align: center;">  <p>RS 485 Term. ON</p> </div> </div>	Connector Label	RS Interfaces			422	232	485	A	A	RxD	—	B	B	—	—	Z	Z	TxD	B	Y	Y	—	A	G	G (GND)		
	Connector Label	RS Interfaces																											
		422	232	485																									
	A	A	RxD	—																									
	B	B	—	—																									
Z	Z	TxD	B																										
Y	Y	—	A																										
G	G (GND)																												
<b>M-Bus</b>		For future release.																											
<b>HART</b>		For future release.																											
<b>Modbus</b>	<b>Address</b>	This parameter configures the Modbus address in the range from 1...247.																											
	<b>RS-232, RS-422, RS-485</b>	Baudrate: 1200, 2400, 4800, 9600, 19200, 38400 Bd Parity: Even, Odd, Mark																											
<b>M-Bus</b>	<b>Address</b>	For future release.																											
<b>Ethernet</b>	<b>IP Address</b>	For future release.																											
	<b>IP Mask</b>																												
	<b>IP Gateway</b>																												
	<b>MAC Address</b>																												
<b>ADE</b>	<b>Control</b>	On or Off																											
	<b>Protocol</b>	1 standard messages 2 extended messages																											
	<b>Dial</b>	4 to 9																											
	<b>Resolution</b>	0.001 / 0.01 / 0.1 / 1 / 10 / 100 / 1000 / 10,000																											





## Miscellaneous Menu

<b>Miscellaneous</b>													
<b>Log</b>	Off, On and Preset												
<b>Power Up</b>	The number of times that the unit has been powered on.												
<b>Settling Time</b>	Measures settling of coils and must be less than one quarter of the excitation period. Zero ms if no detector is connected.												
<b>Language</b>	This parameter allows changing the current language. English is the default setting. The following languages are supported: German (Deutsch), Czech (Cestina), Spanish (Espanol), French (Francais), Russian (Россия), Italian (Italiano).												
<b>Date</b>	Set date of the system in the format day, month, year [DD.MM.YY] used for data logging.												
<b>Time</b>	Set time of the system in the format hour, minutes, seconds [HH.MM.SS] used for data logging.												
<b>EEPROM</b>	Delete all data logging information from the EEPROM.												
<b>Polar Voltage</b>	Measure electrode polarizing voltage in $\pm$ V (only for service purpose).												
<b>Display Rotation</b>	The Display can be rotated to 0°, 90°, 180° and 270°.												
<b>Contrast</b>	The contrast of the display can be adjusted between 14 (low) and 49 (high).												
<b>Datalog Period</b>	<p>The data logging period can be adjusted to the following increments:</p> <ul style="list-style-type: none"> <li>• Every 15 min / 1 h / 6 h / 12 h / 24 h</li> </ul> <p>There is a 500 kB memory with about 30,000 data records for data logging available. The logging capacity is as following (Unidirectional mode):</p> <table border="1" style="margin-left: 20px;"> <thead> <tr> <th>Time Period</th> <th>Duration</th> </tr> </thead> <tbody> <tr> <td>15 min</td> <td>up to 312 days</td> </tr> <tr> <td>1 h</td> <td>up to 1250 days</td> </tr> <tr> <td>6 h</td> <td>up to 20 years</td> </tr> <tr> <td>12 h</td> <td>up to 40 years</td> </tr> <tr> <td>24 h</td> <td>up to 80 years</td> </tr> </tbody> </table> <p>Startup, configuration, and error events that are logged can reduce the data logging capacity. Logging in bidirectional mode reduces the logging capacity by about 40%.</p> <p>The logging information can be downloaded by a PC program, which can be ordered with the following part number: 67354-010.</p>	Time Period	Duration	15 min	up to 312 days	1 h	up to 1250 days	6 h	up to 20 years	12 h	up to 40 years	24 h	up to 80 years
Time Period	Duration												
15 min	up to 312 days												
1 h	up to 1250 days												
6 h	up to 20 years												
12 h	up to 40 years												
24 h	up to 80 years												

## Information Menu

<b>Info</b>	
<b>Serial Number</b>	Serial number of the electronic board.
<b>Version</b>	Software version of the device.
<b>Compilation Date</b>	Date of the software version.
<b>OPT CRC</b>	Checksum of the software update.
<b>APP CRC</b>	Checksum of the application.

## PIN Menu

PIN	
<b>Control</b> 	Activate and deactivate the PIN.
<b>User</b> 	Users logged in with this PIN have access to all user levels. Users at this level do not have access to Service or Admin functions.
<b>Service</b> 	Users logged in with this PIN have access to both service and user-level procedures. Users at this level do not have access to Admin functions.
<b>Admin</b> 	Users logged in with this PIN have access to all procedures. Users at this level have full access to the meter.

## Login Screen

Login	
<b>Login</b>	This screen is available only after the password protection (PIN Control) has been set to ON. Enter your 6-digit password.

## MAINTENANCE

Mandatory, routine or scheduled maintenance should not be required for the M1000 Mag Meter electronics or flow tube after proper installation. However, some occurrences may require personnel to perform the following:

- Flow tube and electrode cleaning
- Circuit board replacement

### **WARNING**

**DO NOT CLEAN COMPONENTS INSIDE THE AMPLIFIER OR JUNCTION BOX.**

### **AVERTISSEMENT**

**NE NETTOYEZ PAS LES COMPOSANTES À L'INTÉRIEUR DE L'AMPLIFICATEUR OU DE LA BOÎTE DE JONCTION.**

### Cleaning the Flow Tube and Electrode

At times flow tube, electrodes, amplifier/junction box housings and the amplifier window may need periodic cleaning, depending on process fluid properties, fluid flow rate and surrounding environment.

Clean the flow tube and electrodes by following the material handling and cleaning procedures documented in Material Safety Data Sheet (MSDS) guidelines for the products(s) that were in contact with the flow tube and electrodes.

Should flow tube and/or electrode cleaning become necessary:

1. Disconnect detector from pipeline.
2. Clean electrodes according to MSDS guidelines.
3. Reconnect detector to pipeline.

## TROUBLESHOOTING

The M1000 mag meter is designed for many years of optimal performance. However, should it malfunction, there are certain things that we recommend you check before contacting our Technical Support department or your local Badger Meter Representative.

### Errors & Warnings

**NOTE:** The M1000 display flashes whenever an error is detected.

Description	Possible Cause	Recommended Action
Coil disconnected	<ul style="list-style-type: none"> <li>Meter not connected.</li> <li>Connection to meter interrupted.</li> </ul>	Check if meter is connected and make sure that cable connection is not interrupted or contact Badger Meter Technical Support.
Coil shorted	Coil cables shorted.	Check coil cables .
Empty pipe	Pipe may not be full.	Make sure that pipe is always filled at the measuring point.
	Medium with low conductivity.	Eventually calibrate new, see calibration of fluid monitoring.
	Cable broken or disconnected.	Check the cable for the empty pipe signal.
Range	Actual flow rate is exceeding the programmed full scale by more than 100%	Reduce flow rate or increase the programmed full scale.
Pulse output	Pulse rate exceed the maximum	Reduce pulse scale (pulse/unit) and/or reduce pulse width configuration.
AD error	Input signal from detector too high.	Check the grounding scheme of the meter installation. See <i>"Meter Grounding" on page 14.</i>
Excitation frequency	The excitation frequency is too high for this detector.	Decrease the excitation frequency in the Meter Setup.
EEPROM	Configuration file is missing.	Contact Badger Meter Technical Support.
Configuration	Configuration file is corrupted.	Contact Badger Meter Technical Support.
Measure Timeout	Measurement was not completed within specific time.	Contact Badger Meter Technical Support.

Some frequently occurring situations:

Description	Possible Cause	Recommended Action
Meter does not function	No auxiliary power.	Apply auxiliary power.
	Fuse is defective.	Replace fuse.
Fluid is flowing, however display shows zero	Signal cable is not connected or connection is interrupted.	Check signal cable.
	Detector installed opposite to forward flow direction (see arrow on type plate).	Turn detector by 180°.
	Connection cable for coils or electrodes mixed-up.	Check connection cable.
Inaccurate measurement	Wrong parameters.	Check parameters (detector, amplifier and size) per <i>"Specifications" on page 33.</i>
	Pipe not completely full.	Check if the measuring pipe is completely full.

## LED Status Indicators

When the LEDs on the circuit board are active, they indicate the status of the device.

LED	Device Status	Label on PCB
LED1	Coil loop connected	COIL
LED2	Communication – receiving	RX
LED3	Communication – transmitting	TX
LED5	Flash memory activity	DISK
LED6	Digital output #1	OUT 1
LED7	Digital output #2	OUT 2
LED8	Digital input	INPUT
LED10	Power ON	POWER
LED13	USB, HOST mode	USB

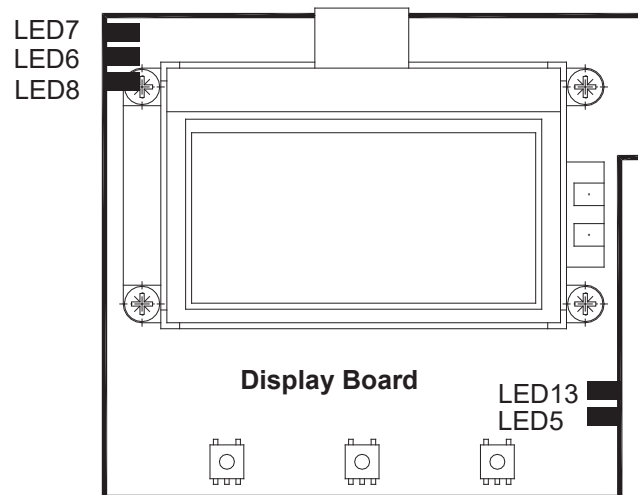
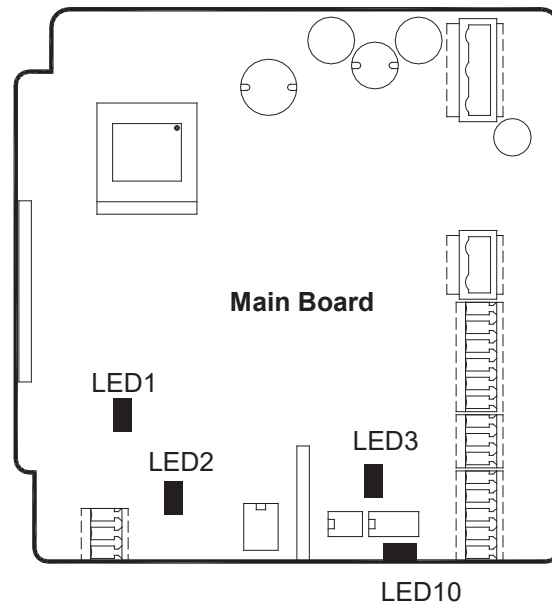



## CONNECTING AN ORION ADE ENDPOINT TO THE M1000 METER

**NOTE:** Connect the endpoint as described. The endpoint automatically updates within one hour. You can force an update using the Endpoint Utility. See the endpoint user manual for programming information.

### Wiring

To connect the ADE endpoint, connect:

ADE Wire	M1000 Terminal
Red (Power/Clock)	Input +
Green (Data)	Out 1 +
Black (Ground)	Out 1 -

Connect a jumper wire from Out 1 negative (-) to INPUT negative (-).

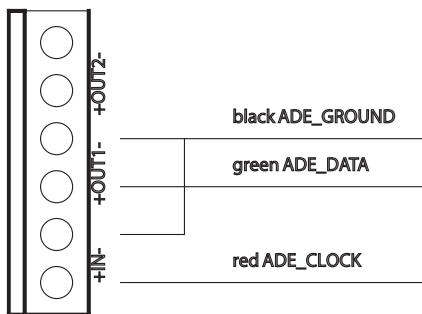

### Programming

Changing the following settings automatically configures *Input* and *Output 1* for ADE.

To program the M1000 meter for the endpoint to Output #1 (forward flow):

1. Navigate to *COMMUNICATION > ADE > CONTROL*.
2. Use the arrows to change the values, then press **EXIT/SAVE**.
3. Repeat steps 1 and 2 for *Control, Protocol, Dials* and *Resolution* (the *Resolution* range is 0.0001...10,000).
4. Press **EXIT/SAVE**.

## SPECIFICATIONS

<b>Flow Range</b>	0.03...12 m/s	
<b>Accuracy</b>	± 0.3% of reading, ± 2 mm/s	
<b>Conductivity</b>	Min. 5 µS/cm (20 µS/cm for demineralized water)	
<b>Fluid Temperature</b>	<b>With Remote Amplifier:</b> PTFE 302° F (150° C), Hard rubber 178° F (80° C)	<b>With Meter-Mounted Amplifier:</b> PTFE 212° F (100° C), Hard rubber 178° F (80° C)
<b>Ambient Temperature</b>	-4...140° F (-20...60° C)	
<b>Flow Direction</b>	Uni-directional or bi-directional	
<b>Analog Output</b>	0/4...20 mA / 0...10 mA, flow direction is displayed on a separate status output	
<b>Pulse Output</b>	2 open collectors, passive 32V DC, 0...100 Hz 100 mA, 100...10,000 Hz 20 mA, optional active	
<b>Frequency Output</b>	Max. 10 kHz (open collector)	
<b>Communication</b>	RS232, RS422, RS485 Modbus RTU	
<b>Empty Pipe Detection</b>	Field-tunable for optimum performance based on specific application	
<b>Min-Max Flow Alarm</b>	Programmable outputs 1...100% of flow	
<b>Low Flow Cutoff</b>	Programmable 0...10% of maximum flow	
<b>Galvanic Separation</b>	Functional 500 volts	
<b>Pulse Width</b>	Programmable 5...2000 ms	
<b>Coil Power</b>	Pulsed DC	
<b>Repeatability</b>	0.1%	
<b>Display</b>	Two lines x 15 characters (7 on top + 8 on bottom), LCD display	
<b>Programming</b>	3 external buttons	
<b>Units of Measure</b>	Gallons, ounces, MGD, liters, cubic meters, cubic feet, imperial gallon, barrel, hectoliter and acre feet	
<b>Power Supply</b>	92...275V AC (50 / 60 Hz), <13 VA optional 9...36V DC, 4W	
<b>Amplifier Housing</b>	Powder-coated aluminium die cast	
<b>Detector Housing</b>	Carbon steel	
<b>Linear Materials</b>	Hard Rubber, PFA, PTFE	
<b>Electrodes Materials</b>	<i>Standard:</i> Hastelloy C	
<b>Grounding Rings</b>	Stainless steel	
<b>Mounting</b>	Detector-mount or remote wall mount	
<b>Approvals</b>	NSF Listed: Models with hard rubber liner 4" size and up; PTFE liner, all sizes	
<b>Cable Insertion</b>	2 x M 20	
<b>Process Connection</b>	Flange: DIN, ANSI, JIS, AWWA	
<b>Nominal Pressure</b>	Up to 232 psi (16 bar)	
<b>Protection Class</b>	<i>Standard:</i> NEMA 4X (IP67); <i>Optional:</i> NEMA 6P	
<b>Pollution Degree</b>	2	
<b>Installation Category</b>	II	
<b>Altitude</b>	2500 m	
<b>Humidity</b>	90% R.H. max.	
<b>Electrical Supply</b>	100...240V AC (±10%). 50/60 Hz, 15 Watts <b>NOTE:</b> Mains supply voltage fluctuations are not to exceed ±10% of the nominal voltage supply.	

**INTENTIONAL BLANK PAGE**

## Control. Manage. Optimize.

M-SERIES is registered trademark of Badger Meter, Inc. Other trademarks appearing in this document are the property of their respective entities. Due to continuous research, product improvements and enhancements, Badger Meter reserves the right to change product or system specifications without notice, except to the extent an outstanding contractual obligation exists. © 2018 Badger Meter, Inc. All rights reserved.

**[www.badgermeter.com](http://www.badgermeter.com)**

---

**The Americas | Badger Meter** | 4545 West Brown Deer Rd | PO Box 245036 | Milwaukee, WI 53224-9536 | 800-876-3837 | 414-355-0400  
**México | Badger Meter de las Americas, S.A. de C.V.** | Pedro Luis Ogazón N°32 | Esq. Angelina N°24 | Colonia Guadalupe Inn | CP 01050 | México, DF | México | +52-55-5662-0882  
**Europe, Eastern Europe Branch Office (for Poland, Latvia, Lithuania, Estonia, Ukraine, Belarus) | Badger Meter Europe** | ul. Korfantego 6 | 44-193 Knurów | Poland | +48-32-236-8787  
**Europe, Middle East and Africa | Badger Meter Europa GmbH** | Nurtinger Str 76 | 72639 Neuffen | Germany | +49-7025-9208-0  
**Europe, Middle East Branch Office | Badger Meter Europe** | PO Box 341442 | Dubai Silicon Oasis, Head Quarter Building, Wing C, Office #C209 | Dubai / UAE | +971-4-371 2503  
**Slovakia | Badger Meter Slovakia s.r.o.** | Racianska 109/B | 831 02 Bratislava, Slovakia | +421-2-44 63 83 01  
**Asia Pacific | Badger Meter** | 80 Marine Parade Rd | 21-06 Parkway Parade | Singapore 449269 | +65-63464836  
**China | Badger Meter** | 7-1202 | 99 Hangzhong Road | Minhang District | Shanghai | China 201101 | +86-21-5763 5412  
**Switzerland | Badger Meter Swiss AG** | Mittelholzerstrasse 8 | 3006 Bern | Switzerland | +41-31-932 01 11